

tnxTower

Version 8.3 General Reference

Tower Numerics Inc.

www.townx.com



September 20, 2024

Copyright 2024 by Tower Numerics Inc. All rights reserved.

No portion of the contents of this publication may be reproduced or transmitted in any means without the express written permission of Tower Numerics Inc.

We have done our best to ensure that the material found in this publication is both useful and accurate. However, please be aware that errors may exist in this publication, and that Tower Numerics Inc. makes no guarantees concerning the accuracy of the information found here or in the use to which it may be put.

Contents

tnxTower	i
Contents	i
Overview	7
Introduction	7
Data Entry	8
Output Reports	8
Some Current Limitations	8
Installing and Configuring	10
Minimum System Requirements	10
Installing the Program	10
Un-Installing the Program	10
Readme.txt	10
Technical Support	10
Licensing	12
License Agreement	12
Configuring tnxTower	17
Program License File	17
Project Settings	18
User Information	20
Display and Printing	21
US Customary & SI Metric Units	23
Licensing	25
Keyboard Definitions	27
Description	27
Editing Tower Data	29
Summary	29
Code Data	29
Design Code	29
Design Mode	30
Other Design Options	30
Ice Requirements	31
Thermal	31
Miscellaneous	31
Wind Requirements	32
Seismic Requirements	34
Tornado Loads	34
Oscillations and Fatigue	35
CAN-S37-01 Input	36
Save As Default	36
General Options	37
Cantilevered Poles	40
Tension Only Systems	41
Critical Rotation Reports	42
Girt Offsets	42
Foundation Stiffness	42

Wind Directions	42
Geometry Data.....	44
General Tower Data	44
Generating Latticed Pole Data	48
Generating Circular Pole Data	65
Generating Tapered Pole Data	65
Generating Base Tower Data	66
Advanced Data.....	83
Summary	83
Area Adjustment Factors	83
Irregular Projected Area Adjustment Factors (Ratios):.....	83
Weight Adjustment Factor	84
Pressure Adjustment Factor	84
K Factors.....	84
Connection Data.....	86
Diagonal Offsets	87
Guy Data	89
Guy Data Entry	89
Discrete Load Data.....	101
Summary.....	101
Discrete Load Data.....	101
User Forces Data	107
Summary.....	107
User Forces Data.....	107
Feed Tower Data	109
Summary.....	109
Feed Tower Data.....	109
Antenna Pole Data.....	111
Pole Properties	111
Pole Forces.....	111
Beacon Forces.....	111
Force-Couple.....	112
Feed Line Load Data.....	113
Summary.....	113
Feed Line Load Data.....	113
Dish Data.....	123
Summary.....	123
Dish Data	123
Foundation Data.....	128
Summary.....	128
Cost Data.....	130
Summary.....	130
Monopole Reinforcement.....	131
Summary.....	131
Candelabra Data	133
Summary.....	133
Equipment Load Cases	135
Summary.....	135
Data Storage Tags	138
Summary.....	138
Command Line API	139
Summary.....	139
Viewing Reports	141
Report Options	141

Input Data.....	141
Running the Solution	143
Summary	143
Self-Supporting Towers	143
Guyed Towers.....	144
Editing Section Databases	145
Adding, Editing and Viewing Sections	145
Steel Shapes	146
Synchronizing Databases	153
Editing Material Databases	157
Adding, Editing and Viewing Material Grades	157
Editing Component Databases	160
Adding, Editing and Viewing Sections	160
Feed Line Shapes	161
Dish Shapes.....	162
Appurtenance Shapes.....	162
Assemblies	163
Geometry View	165
Summary	165
Sending Plots To Clients Electronically.....	165
Using The Pop-Up Menu	166
The Geometry View Toolbar	167
The Overview Window.....	167
Material Take-off View	169
Summary	169
Adding In User Defined Notes.....	170
Plot Plan View	171
Summary	171
Leg Compression View	173
Summary	173
Mast Shear & Moment View	175
Summary	175
Specifying A Load Combination	175
Deflection View	177
Summary	177
Specifying A Load Combination	177
Guy Anchor View	179
Summary	179

Specifying A Load Combination And Guy Anchor Location	179
Feed Line View	180
Distribution View	180
Changing The Elevations Of The View	180
Plan View	181
Stress Distribution View	183
Summary	183
Changing The Elevations Of The View	183
Press/Ice View	185
Summary	185
Foundation View	187
Summary	187
Monopole Base Plates	187
Export to RISA-3D	189
Opening model files in RISA-3D	189
Overview	189
Export To Other Programs	191
Summary	191
AutoCad DXF	191
SDNF	191
ASCII Cost Output	192
Viewing tnxTower Model Files	193
Sending Files To Clients	193
List of Necessary Files	193
tnxCable	195
Summary	195
Overview	195
Data Entered by the User	195
Data Retrieved from the Database	196
Values Calculated by the Program	196
tnxCable Report	196
Candelabra Editing and Import	197
Before you begin	197
Summary	197
Using the Candelabra Editor	197
Modeling candelabras in RISA-3D	207
Pedestal Definition	226
Triangular Candelabra	227
Candelabra Section Sets	230
Technical Appendix	234

Solution Parameters	234
Non-Linear Analysis	235
Some Useful Facts	237
Three Sided Tower Equations.....	237
Four Sided Tower Equations.....	237
Modeler Rules	238
Feed line Stacking	241
Projection of Discrete Appurtenance Areas	242
Impact of monopole feed line and IPA settings on Cf and total EPA of attachments (TIA-222-G) ...	243
How the Modeler Calculates the Guy Anchor Location	247
How K-Factors Are Applied	247
Diagonal Members.....	247
K-Brace Horizontals	248
Auto-Calculation of K-Factors	249
Solid Round Members	249
Single Angle Members.....	249
Leg Connections	251
Design of Grouted Pipe	254
Mast Stability Index	255
Calculation of Combined Stress Ratios in Latticed Masts	255

Troubleshooting **258**

Modifying the TNXTOWER.INI File	258
Restricting Database Access	258
Changing The tnxTower Header in Printed Reports	258
Frequently Asked Questions	259
Question 1	259
Question 2	259
Question 3	259
Question 4	259
Question 5	259
Question 6	260
Question 7	260
Question 8	260
Question 9	260
Question 10	260

Index **261**



Introduction

tnxTower is a general-purpose modeling, analysis, and design program created specifically for communications towers using the RS-222, RS-222-A, RS-222-B, EIA-222-C, EIA-222-D, EIA-222-E, TIA/EIA-222-F, TIA-222-G, TIA-222-H, and TIA-222-I Standards, as well as the Canadian CSA-S37-01 Standard.

The program will:

- Automatically generate nodes and elements for a subsequent finite element analysis (FEA) for standard tower types including self-supporting towers, guyed towers and monopoles.
- Automatically determine the pressure coefficients, wind pressures, ice loads and resulting forces on the tower.
- Allow entry of dishes, feed lines, discrete loads (loads from appurtenances) and user defined loads anywhere on the tower.
- Generate guy cables at varying radii and guy anchor elevations.
- Allow for an optional inner feed line support tower.
- Allow for an upper-latticed pole structure.
- Allow for a separate antenna pole structure placed upon the top of the tower.
- Analyze only, check specified member cross-sections, or design the lowest weight structure.
- Automatically calculate shielding of feed lines.
- Allow for calculation of center of pressure due to offset feed lines.
- Automatically calculate K-factors for solid round and single angle members.
- Check or design bolts in tower members.

The types of towers that can be analyzed are:

- Three or four sided guyed tower
- Three or four sided self-supporting tower
- Ground mounted monopoles
- Three or four sided guyed monopoles

The types of antenna sections (latticed poles) that can be added to the tower are:

- Three sided latticed pole
- Four sided latticed pole

- Round stepped pole
- Tapered pole (round, 18, 16, 12 and 8 sided)

Data Entry

The designer specifies the geometry and loads on the tower through a series of easy to use spreadsheets. Units can be either US Customary or SI Metric. Additionally, individual units can be specified as to type (lb or kips) and precision (number of significant digits to display). US length units may also be displayed in architectural (12'-6 5/8") style.

Output Reports

The program generates extensive reports in Microsoft Rich Text Format (RTF). Reports may be viewed directly within Microsoft Word or with the optional Microsoft Word Viewer (information available here: <http://support.microsoft.com/kb/891090>)

There are also several graphical display screens which help to show the output in a more concise and easy to understand format. They include:

- Material list view showing member sizes, weights, and graphical display of the tower section with reactions and tables of user defined components. User defined notes may also be added to this view.
- Plot plan showing boundary of tower and acreage required for 15' clearance.
- Leg compression plots also displaying the leg compression and tension capacity of the tower.
- Mast shear and moment plots.
- Tower deflections, tilt and twist.
- Guy anchor plots showing guy forces and guy anchor reactions (for guyed towers only).
- Feed line plot. Displays feed lines in each of the faces of the tower.
- Stress plot. Graphically displays the stress condition of members in each face of the tower.

Some Current Limitations

- Specialty appurtenances such as candelabra mounts can only be entered as user defined or discrete loads. A candelabra editor is currently under development.
- When horizontals on the tower are used for climbing purposes, the program does not check the 250 lb climbing load provision of 222-F.
- Feed line forces are applied along with mast forces to leg members and are not applied directly to tower horizontals. When significant bending is introduced in the horizontal members, then you must check this condition manually.
- Highly non-linear towers that are too flexible, severely overstressed (buckling), or torsionally unstable may not be able to be analyzed by tnxTower.
- Wind loads are applied to the tower legs and leg nodes. Wind pressure is not directly applied to horizontal and diagonal members. This is done to better conform to the manner in which most towers have been designed in the United States.

- Check of gusset plate and flange plate welds are not performed in the program.
- Monopole anchor bolt checking currently only includes steel strength and does not include concrete breakout strength.
- Seismic effects are not determined automatically. Seismic forces considered in load combinations are only those entered on the User Forces page.

Minimum System Requirements

Operating system: Windows Vista, 7, 8, 10 and 11. Both 32 and 64-bit versions are supported.

Processor:	Intel Pentium III or better, 1.5 GHz minimum
Ram Memory:	512 Mb minimum
Disk Space:	100 Mb free for data files
Screen Resolution:	1024x768 or higher recommended
Printer:	8 1/2x11 b/w minimum, 11x17 color recommended

The display should be set to display Normal Fonts (do not use Large Fonts as they may distort some of the graphics images).

Installing the Program

tnxTower is distributed as an executable installation pack. The pack needs to be downloaded to a folder on the user's workstation and run. Administrative privileges are required for the installation.

The installation pack for the most recent version of the program is posted on our [Product Licensing page](#).

Un-Installing the Program

To un-install the program, go to the Windows Control Panel and choose Add/Remove Programs. Then select tnxTower. All files, registry entries and icons that were installed will be removed. Any files that were created after the program was installed will not be removed and will have to be manually removed through Windows Explorer.

Readme.txt

The program contains a readme.txt file that contains a listing of all of the current enhancements, bug fixes, changes, etc. for the program. You may view this file by clicking on Help->About tnxTower and clicking the readme button.

Technical Support

Before contacting technical support, please verify the version number of the program you are running. This may be found by clicking on Help | About in the

main menu. The About dialog box contains a button which, when pressed, will display the current Readme.txt file. This file contains information about changes, enhancements and bug fixes.

Technical support is usually handled via email. Send your questions to support@townrx.com. You may do this directly from within the tnxTower program using the File | Send menu command. This command will attach your current model file directly to the email. Note that some non-Microsoft compatible mail systems may not work using this method and you will have to manually attach the model file to the email.

In addition, technical support is available via phone at 781-862-0966. Hours are from 9 AM to 5:00 PM ET.

Technical support questions should be limited to the use of the program. Should you have specific questions about the TIA standard or designing towers in general, we will try to direct you to other tnxTower users who may be available to consult with you.

Licensing

tnxTower software is licensed as a subscription on a yearly renewal basis.

Access to the software is controlled by an Internet license server. The user has the option of checking out the license for a specified length of time. In such a case the license is transferred to the user's workstation for the duration of the checkout, and no Internet access is required for the program to operate.

License Agreement

Tower Numerics Inc. End User License Agreement:

THIS END USER LICENSE AGREEMENT (the "AGREEMENT") is a legal agreement entered into and made effective as of the date You accept this AGREEMENT (the "Effective Date") and is by and between You and Tower Numerics Inc., ("Tower", "We", "Us" or "Our") a Massachusetts corporation.

As used in this AGREEMENT the term "SOFTWARE" means the tnxTower software product, any associated media and databases, and any related printed materials and electronic documentation. By downloading, copying, installing, using or otherwise accessing the SOFTWARE, You represent (i) that You accept, and have been authorized to accept, these terms on behalf of the customer (the entity on whose behalf you are acting, in which event "You" and "Your" shall refer to you and such entity), or (ii) that You agree to be personally bound by the terms of this AGREEMENT as the customer (in which case "You" and "Your" refers to you alone). **If You are not so authorized or do not agree with the terms of this AGREEMENT, (i) Tower is unwilling to provide the Subscription or grant You access to the SOFTWARE, (ii) You are not permitted to use the SOFTWARE, and (iii) You must promptly return to Tower, or destroy, all copies of the SOFTWARE and related materials made available to You.** Provided You comply with the foregoing requirements of return or destruction within fourteen (14) days of purchase, Tower will refund any payments made by You in advance for the cancelled Subscription. If You accept these terms on behalf of an entity, You may use the SOFTWARE only on behalf of such entity. If You intend to be personally bound, use of the SOFTWARE is limited to your personal use. The terms of this AGREEMENT supersede any conflicting terms in any confirmation, purchase order or other document You may submit.

Any notice delivered by Tower to You under this EULA will be delivered via email, regular mail, or postings on towernx.com. Notices to Tower should be sent via email to licensing@towernx.com.

Copyright 2010-2024 Tower Numerics Inc. All rights reserved. The SOFTWARE is protected by United States copyright laws and various international treaties. All rights not specifically granted under this AGREEMENT are reserved by Tower. "TNX" and "tnx", as applied to structural engineering software are trademarks of Tower Numerics Inc.

1. TERM AND SCOPE OF SUBSCRIPTION: This AGREEMENT grants You a license to use the SOFTWARE, plus associated maintenance for a period of one year commencing on the Effective Date (the "Initial Term"), and for successive one-year terms (each, a "Renewal Term" and collectively, the "Subscription Term") if so elected and paid for by You. The terms of this AGREEMENT are binding for so long as You have an active Subscription or You use or have access to the SOFTWARE.

2. SOFTWARE ACCESS. Subject to Your acceptance of and compliance with this AGREEMENT, Tower grants to You a non-exclusive, non-transferable, revocable limited license to use the SOFTWARE. For the avoidance of doubt, the SOFTWARE is licensed to You, not sold. All right, title and interest are and remain vested in Tower. The SOFTWARE is licensed per process instance. Each individual instance of the SOFTWARE consumes a separate license. Multiple instances of the SOFTWARE running on the same physical or virtual hardware are each treated as individual instances. You are authorized to use concurrently no more than the maximum number of SOFTWARE instances for which Subscription Fees have been paid, as specified in the purchase documentation you receive from Tower. The following additional terms apply:

2.1 Usage Controls. You agree that: (a) The number of instances of the SOFTWARE accessed at any time may not be greater than the number for which Subscription Fees have been paid, (b) User's credentials may not be shared with anyone who is not a User, and (c) a User identification may be reassigned to a new individual replacing one who no longer requires ongoing use of the SOFTWARE. A "User" is an individual who is authorized by You to access the SOFTWARE pursuant to Your Subscription, and to whom You (or We, at Your request) have supplied SOFTWARE access credentials. Users should be limited to (a) an individual who purchased the SOFTWARE or (b) employees of the purchaser, if a company. If You are unable or unwilling to abide by a contractual usage limit, We may disable such excess use, charge You for such excess use (e.g., by increasing the number of authorized computers and billing You retroactively for these additional computers for the entire annual Subscription Term in which this occurred) and/or terminate or suspend Your Subscription, all without liability therefor and at Tower's sole discretion.

2.2 Your Responsibilities. You will (a) be responsible for Users' compliance with this Agreement, (b) use commercially reasonable efforts to prevent unauthorized access to or use of the SOFTWARE, and notify Us promptly of any such unauthorized access or use, and (c) use the SOFTWARE only in accordance with the documentation and applicable laws and government regulations.

2.3 Usage Restrictions. You will not (a) make the SOFTWARE available to, or use the SOFTWARE for the benefit of, anyone other than You or Users, (b) sell, resell, license, sublicense, distribute, rent or lease the SOFTWARE or access to the SOFTWARE, or include the SOFTWARE in a service bureau or outsourcing offering, (c) use the SOFTWARE to store or transmit infringing, libelous, or otherwise unlawful or tortious material, or to store or transmit material in violation of third-party privacy rights, (d) use the SOFTWARE to store or transmit malicious code, (e) interfere with or disrupt the integrity or performance of the SOFTWARE or third-party data contained therein, (f) attempt to gain unauthorized access to the SOFTWARE or its related systems or networks, (g) permit direct or indirect access to or use of the SOFTWARE in a way that circumvents a contractual usage limit, (h) copy the SOFTWARE or any part, feature, function or user interface thereof, (i) access the SOFTWARE in order to build a competitive product or service, or (j) reverse engineer the SOFTWARE (to the extent such restriction is permitted by law). If the SOFTWARE was purchased at a discounted price for educational purposes it may in no event be used for professional design purposes.

3. LIMITATION OF LIABILITY. We intend that the information contained in the SOFTWARE be accurate and reliable, but it is entirely the responsibility of You and Your Users to verify the accuracy and applicability of any results obtained from the SOFTWARE. The SOFTWARE is intended for use by professional engineers who possess an understanding of structural mechanics. In no event will Tower or its officers, employees or agents be liable to anyone for any incidental, special, punitive or consequential damages, including any lost profits, lost savings or lost data, or for any professional malpractice or product liability arising out of or in connection with the usage of the SOFTWARE or any associated services, even if Tower or its officers have been advised of or should be aware of the possibility of such damages. In no event whatsoever shall the entire liability of Tower from any and all causes (including without limitation breach, negligence, product liability and infringement) exceed the Subscription fee actually paid by You for the SOFTWARE for the Subscription Term in which the claim accrued.

4. LIMITED WARRANTY. Tower represents and warrants that it will use diligent efforts to ensure that the SOFTWARE will contain the functions and operate substantially in accordance with the user documentation during Your Subscription Term, provided that (i) We do not warrant that the SOFTWARE will operate error free or without interruption, and (ii) We may elect to modify the features and functions of the SOFTWARE during Your Subscription Term, but will not eliminate any material features You rely on without allowing You to terminate Your Subscription and receive a refund of Your prepaid fees prorated for the period after termination. Tower's sole obligation and Your exclusive remedy under this limited warranty will be to receive support from Tower via telephone or e-mail. EXCEPT AS STATED ABOVE THE SOFTWARE AND ANY RELATED SERVICES ARE PROVIDED WITHOUT WARRANTY, EXPRESS OR IMPLIED, INCLUDING WITHOUT LIMITATION THE IMPLIED WARRANTIES OF MERCHANTABILITY, OF FITNESS FOR A PARTICULAR PURPOSE AND AGAINST INFRINGEMENT, all of which are hereby disclaimed.

5. MAINTENANCE AND SUPPORT. Tower shall provide You with maintenance and support services ("**Support**") as part of your paid Subscription. Support consists of patches and upgrades for the SOFTWARE as they are released to Our customer base and response to service inquiries and problem reports within a reasonable time by telephone or email.

6. PROTECTION; PRIVACY. We use a third party Internet service (the "**Authorization Vendor**") to manage Your use of the SOFTWARE so that it does not exceed the scope of rights You have purchased.

6.1 Disclosing All Usage. You are specifically prohibited from attempting to bypass these Internet controls by any means. If these controls become broken or inoperable, or if You defeat or tamper with them, You will fully disclose to Tower all actual usage of the SOFTWARE by You and Your Users and will permit Tower or its designee to physically inspect the sites and systems where You use the SOFTWARE to audit and correctly compute Your actual usage and to charge You for it at Our highest applicable fee schedule.

6.2 Confidentiality and Privacy. Tower respects the confidentiality of any trade secrets or private information We may learn about You and Your Users. However, You acknowledge that, as part of the authorization process, our usage controls transmit the logon names of current Users to the Authorization Vendor, and You agree (a) that our Authorization Vendor may collect (and claim ownership of) anonymous system data regarding the use and functioning of its authorization system by Users, including hardware characteristics, operating system data, installed software data, IP addresses, session durations, device names, and Windows logon names, but *excluding* logon passwords, data created by Customer using the Software, or any other Customer or personally identifiable data, and (b) that any of Your data processed or stored by use of the Software by You and Your Users may be processed and stored wherever the Authorization Vendor's servers reside, including outside the U.S.

7. FEES AND PAYMENTS. You will pay all fees as set forth in Section 7.1. Unless otherwise provided herein, payment obligations are non-cancelable and fees paid are non-refundable.

7.1. Fees. Upon execution of this AGREEMENT, You shall pay the Annual Subscription Fee (as quoted by Us in writing) for the Initial Term. If You wish to renew Your Subscription, You shall pay additional Annual Subscription Fees (as quoted by Us in writing) per annual Renewal Term, which amount may be increased by Tower at any time upon at least sixty (60) days advanced notice. Should You fail to pay Your Annual Subscription Fee prior to the termination of the then current annual term, the Subscription shall expire at the end of the then current term, unless earlier terminated. Any fees or other amounts due and payable hereunder which are not paid on or before each due date will bear interest at the rate of one percent (1%) per month (or the highest rate permitted by applicable law, if less). You are responsible and liable for any fees, including reasonable attorney and collection fees, that Tower may incur in its efforts to collect any remaining overdue balances from You.

7.2. Invoicing and Payment. All fees shall be due and payable within thirty (30) days of receipt of Tower's invoice. You are responsible for providing complete and accurate billing and contact information to Tower and notifying Tower of any changes.

7.3. Failure to Pay Annual Subscription Fee. Payment of the Annual Subscription Fee will be required to access the SOFTWARE and to be eligible for upgrades and technical support. If any invoiced amount is not received by Tower within thirty (30) days after the date the invoice was issued, then without limiting Tower's rights or remedies, Tower may terminate Your access to the SOFTWARE.

7.4. Taxes. Tower's fees do not include any taxes, levies, duties or similar governmental assessments of any nature, including, for example, value-added, sales, use or withholding taxes, assessable by any jurisdiction whatsoever (collectively, "**Taxes**"). You are responsible for paying all Taxes associated with its purchases hereunder. If Tower has the legal obligation to pay or collect Taxes for which You are responsible under this Section, Tower will invoice You and You will pay that amount unless You provide Tower with a valid tax exemption certificate authorized by the appropriate taxing authority.

Tower is solely responsible for taxes assessable against it based on its income, property and employees.

7.5. Future Functionality. You agree that Your purchases are not contingent on the delivery of any future functionality or features, or dependent on any oral or written public comments made by Tower regarding future functionality or features.

8. TERMINATION. This AGREEMENT commences on the Effective Date and continues until the Subscription has expired or has been terminated in accordance with the terms hereof.

8.1. Tower may terminate Your Subscription and right to use the SOFTWARE if You fail to comply with any terms or conditions of this AGREEMENT and fail to correct such failure within ten (10) days of notice from Tower. In such event You must delete and destroy any copies of the SOFTWARE in Your possession or control and promptly return the associated documentation to Tower.

8.2. You may also elect to terminate Your Subscription at any time, by notice thereof to Tower. In neither case 8.1 or 8.2 will You be entitled to a refund.

8.3. Tower may terminate Your Subscription at any time, in its sole discretion. If such termination is not due to Your breach or misconduct, Tower will refund a portion of the Subscription fee paid by You, prorated for the period that follows termination.

9. EXPORT CONTROLS. You agree to comply with all export and import laws and restrictions and regulations of the United States or any foreign nation, and not to export, re-export or import the SOFTWARE in violation of any such restrictions, laws or regulations.

10. CHOICE OF LAW. By entering into this AGREEMENT You agree to the exclusive jurisdiction of the state and Federal courts of the Commonwealth of Massachusetts, USA, for resolution of any dispute between the parties, including any claims You may have relating to the SOFTWARE or other goods or services provided by Tower. All disputes therefore shall be resolved in accordance with the laws of Massachusetts, and all parties to this AGREEMENT expressly agree to exclusive jurisdiction within Massachusetts. No choice of law rules of any jurisdiction apply.

Configuring tnxTower

Program License File

When the program starts, it connects to a cloud licensing server to obtain its authorization to run. Connection parameters are contained in a license file (*.lic), which you have received from TNX in the initial setup email.

The license file should be placed in the C:\Users\Public\Documents\TNX Licensing**RLM** folder on each machine running tnxTower.

Important: The license file enables access to the pool of licenses allocated to your organization. It should be treated with appropriate care and confidentiality.

License Deactivation

To remove access to the program from a particular machine, just remove the license file from its RLM folder (see above).

Project Settings

The screenshot shows the 'Settings' dialog box for tnxTower. It is organized into several sections:

- Project Information:** Includes text boxes for Job (Example Guyed Tower), Project (12345-67), Client Name (ABC Inc.), Created By (John Smith), and Last Used By (John Smith). It also has Date fields for Created (Mon Mar 01 14:45:35 1999) and Last Used (Sat Oct 10 00:07:41 2015).
- System of Units:** Features radio buttons for 'US Customary' (selected) and 'Metric'.
- File Location Pathnames:** Contains text boxes for 'Temporary Files' (C:\Users\John_Smith\AppData\Local\Temp\) and 'Database Files (Root Directory)' (C:\Users\Public\Documents\tnxTower Files\DBFiles\), each with a browse button (...).
- Design Standard Series:** Has a dropdown menu with 'ANSI/TIA/EIA Standards' selected. A note indicates 'Specific edition must be selected on the Tower Input page'.

At the bottom of the dialog are buttons for 'OK', 'Cancel', 'Apply', and 'Help'.

Job

Enter a description for the job.

Project

Enter a description for the project. This could also be used for a project number.

Client Name

Enter the client's name.

System of Units

Choose from US Customary Units or SI Metric Units. You can select US Customary for entering data and then you can change to SI Metric and your data will be automatically converted. When switching from one system to another, you may notice some slight round off due the conversion.

Design Standard Series

Currently tnxTower supports the US and Canadian tower design standards. Selection of the specific standard series (ANSI/TIA/EIA or CSA S37) enables relevant data entry fields of the Tower Input pages.

File Location Pathnames

tnxTower makes use of two customizable pathnames. The first is the location where temporary files can be created and deleted when no longer required. This defaults to the c:\temp or to whatever the environment label TEMP or TMP is set to in the operating system.

The second pathname is the location where database files can be located. These are ordinarily located in sub-directories beneath the DBASE directory located in the tnxTower installation directory. The databases are created in layered directories each representing a specific type of database. For example, the steel databases are located in the DBASE\STEEL directory and appurtenances are located in the DBASE\MISCL\APPURT directory. The pathname to be entered is the **root** path that contains the DBASE directory. When databases are to be shared on a network, you will probably want to specify the complete network path to the root directory for the DBASE sub-directory (but not including the DBASE directory).

A browse button is situated just to the right of each of these pathnames. Click on the button and the following browse dialog box appears.

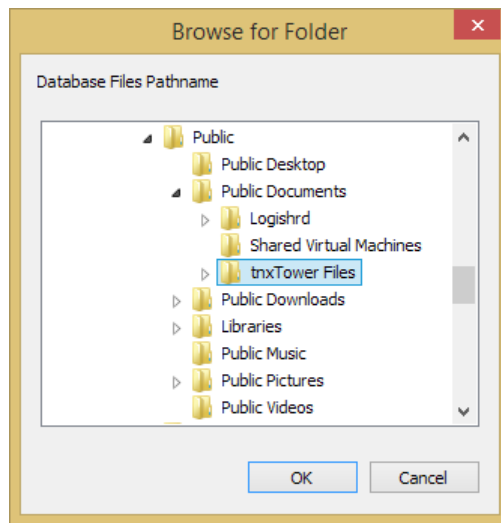

User Information

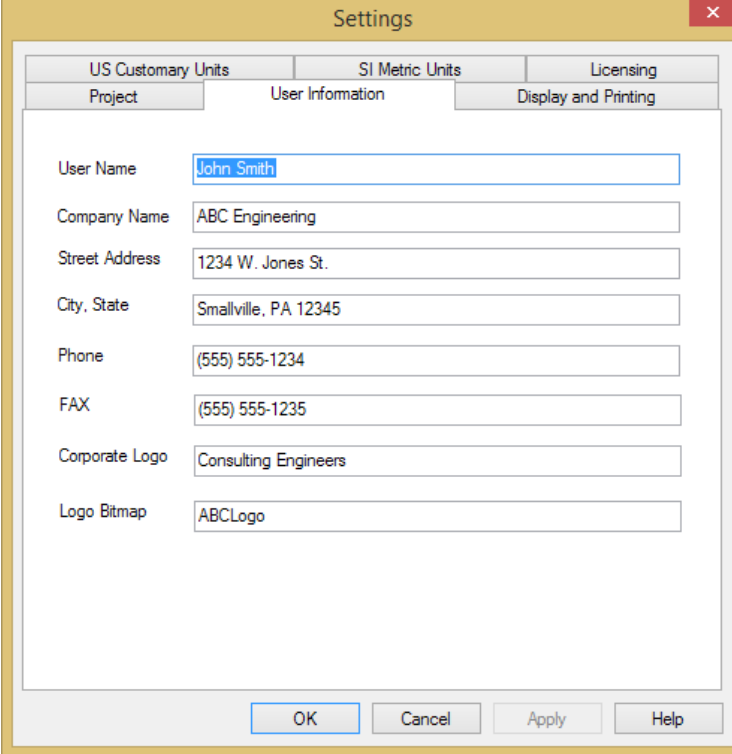

The screenshot shows a 'Settings' dialog box with a 'User Information' tab selected. The dialog has three main sections: 'US Customary Units', 'SI Metric Units', and 'Licensing'. The 'User Information' section contains the following fields:

Field	Value
User Name	John Smith
Company Name	ABC Engineering
Street Address	1234 W. Jones St.
City, State	Smallville, PA 12345
Phone	(555) 555-1234
FAX	(555) 555-1235
Corporate Logo	Consulting Engineers
Logo Bitmap	ABCLogo

At the bottom of the dialog are buttons for 'OK', 'Cancel', 'Apply', and 'Help'.

User settings are inserted into drawing title blocks and report headings. Most of these items are self-explanatory.

Corporate Logo

The corporate logo should be kept short, say no more than 24 characters. The logo is placed below the logo bitmap in drawing title blocks. The logo can be left blank.

Logo Bitmap

tnxTower makes use of two bitmaps in drawing title blocks. There is a black background bitmap for viewing on the screen and a white background bitmap for printed drawings. The bitmap filenames must have a B (for black) and W (for white) appended to their names. As an example, the program defaults to a logo bitmap name of ABCLogo. You will find two files, ABCLogob.bmp and ABCLogow.bmp in the installation directory. You may use these two bitmap files as a basis for creating your own company bitmap.

Please try and keep the overall size of the bitmap approximately the same as the ABCLogo bitmap or it may not display properly in the title block.

Display and Printing

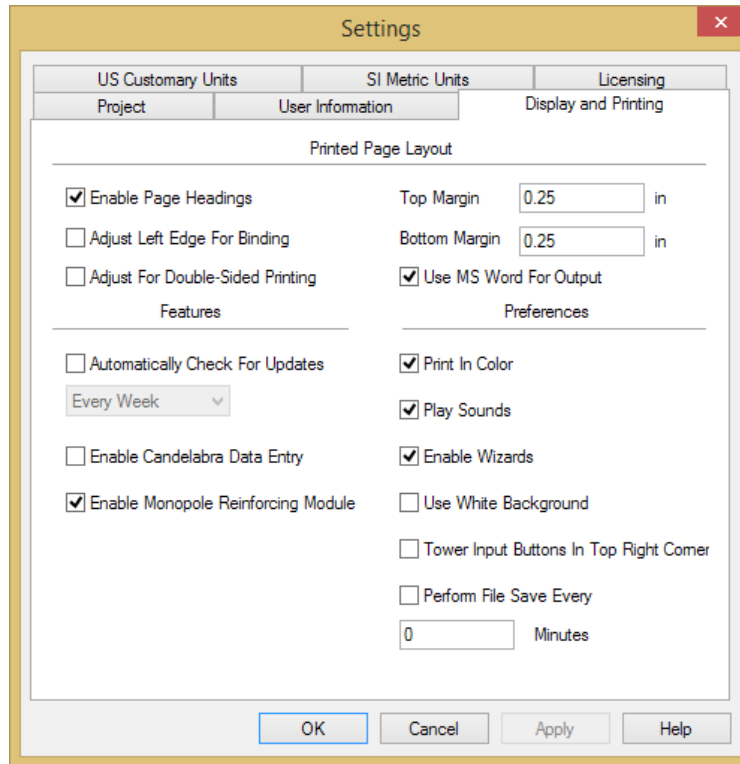

tnxTower makes use of .RTF files (Word compatible) to print reports. Printer settings control how reports are formatted.

Printed Page Layout

- **Enable Page Headings.** When checked, reports will have a title block placed at the top of each page.
- **Adjust Left Edge For Binding.** When checked, the left edge is indented to accommodate punched paper.
- **Adjust For Double-Sided Printing.** When checked, a gutter is created so that pages are alternately adjusted book style.
- **Top and Bottom Margin.** Set the amount that the margin should have. Please note that some printers may override these values with their own minimum values.

Features

- **Automatically Check For Updates.** This setting controls the Update Auto-Notification feature of tnxTower. When a specific notification frequency is set here, the program will query TNX's server to obtain the most recent version number of the software. No other information is sent to or received from the server.

If an update is available, the user will be notified by a pop-up message box containing the new version information, as well as instructions for downloading the software.

This feature may be entirely disabled by unselecting its checkbox.

- **Play Sounds.** When checked, tnxTower will play music for certain critical events, namely start-up, shutdown, end of analysis run and critical errors.
- **Enable Candelabra Data Entry.** When checked, the **Tower Input** tabs will include Candelabra. Please refer to the Candelabra input instructions elsewhere in this Manual.
- **Enable Monopole Reinforcing Module.** When checked, the **Tower Input** tabs will include Monopole Reinforcing. Please refer to the Monopole Reinforcing input instructions elsewhere in this Manual.

Preferences

- **Print In Color.** When checked, various graphics reports in full color.
- **Play Sounds.** When checked, tnxTower will play music for certain critical events, namely start-up, shutdown, end of analysis run and critical errors.
- **Enable Wizards.** Not currently used in tnxTower.
- **Use White Background.** When checked, the graphics views are displayed with a white background instead of the customary black.
- **Tower Input buttons in top right corner.** When checked, the OK, Cancel, Apply and Help buttons are placed in the upper right corner of the Tower Input screen. This configuration is desirable for certain screen resolutions.
- **Perform File Save Every n Minutes.** When checked, tnxTower will automatically save your file at the specified interval.

Output Options

- When Microsoft Word is installed, then check the **Use MS Word for Output.** Otherwise, you may install the Microsoft Word Viewer (information available here: <http://support.microsoft.com/kb/891090>).
- **Generate XML Output Files.** When checked, tnxTower will generate an additional output file in the XML format. The contents of the file may be browsed in an XML reader or processed by an automated system with such capabilities.
- **Generate AUXDATA Output Files.** When checked, tnxTower will generate an additional output file in the XLSX format. The file, depending on the tower type, contains tower section weights or monopole structural analysis responses. The file contents can be used in input data preparation or analysis postprocessing.

US Customary & SI Metric Units

Settings

Project		User Information		Display and Printing	
US Customary Units		SI Metric Units		Licensing	
	Type	Precision		Type	Precision
Length	ft	3	Properties	in	3
Coordinate	ft	3	Deflection	in	3
Spacing	ft	3	Rotation	deg	3
Force	K	3	Stress	ksi	3
Line Load	klf	3	Strength	ksi	3
Pressure	ksf	3	Modulus	ksi	3
Moment	kip-ft	3	Velocity	mph	1
Density	pcf	0	Acceleration	G's	2
Unit Wt	plf	3	Thermal	F	0

Use Architectural Notation Make These US Settings The Default

OK Cancel Apply Help

Settings

Project		User Information		Display and Printing	
US Customary Units		SI Metric Units		Licensing	
	Type	Precision		Type	Precision
Length	m	4	Properties	mm	0
Coordinate	m	4	Deflection	mm	2
Spacing	m	4	Rotation	rad	4
Force	N	2	Stress	kPa	0
Line Load	N/m	2	Strength	kPa	0
Pressure	kPa	2	Modulus	kPa	0
Moment	N-m	0	Velocity	kph	0
Density	N/cm	2	Acceleration	G's	2
Unit Wt	N/m	2	Thermal	C	0

Make These SI Settings The Default

OK Cancel Apply Help

These two dialogs allow you to determine what type of unit you wish to use and how many decimal places (precision) you want to see printed.

***Use Architectural
Notation***

Available only in US Customary units. When checked, length units are displayed in feet and inches (e.g., 10' 5-7/8") instead of decimal notation.

***Make These Settings
the Default***

Units settings are stored within each job that you do. When checked, these units settings will be the default whenever a new job is created. Previously created jobs are not affected.

Licensing

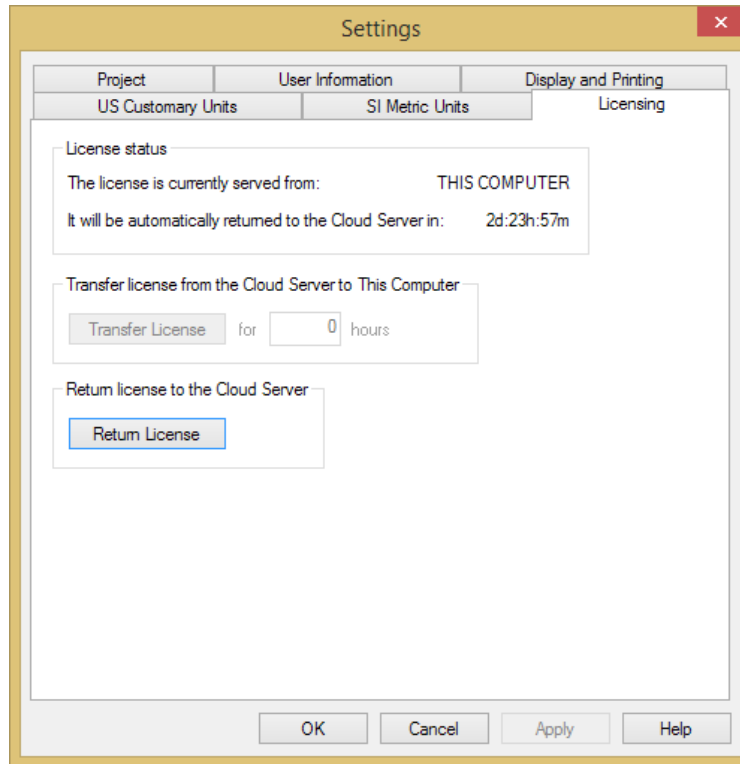

On the Licensing page the user can manage the authorization mode for the software and reset the license data.

License status. The program requires a license to run. It obtains this license when it starts, and then periodically checks the license status during its execution. The license can be served from either the TNX Cloud Server, or from the local machine.

By default, all licenses for all users are obtained from the Cloud Server. tnxTower operating in this mode requires that an Internet connection be available.

The user may transfer the license to the local machine for a specified length of time. After the license is transferred it is served from the user's machine and no Internet connection is required to facilitate it. The license can be transferred back to the Cloud Server at any time.

Once the time for which the license was transferred to the local machine elapses, the license expires on the local machine and becomes available on the Cloud Server. If at that point the machine using the license has a running instance of tnxTower, it will automatically switch to the Cloud Server licensing mode. Otherwise, the license becomes available to any machine using the associated license entitlement.

The currently active license server is indicated in the "The license is currently served from:" field as CLOUD SERVER or THIS COMPUTER.

If the license is currently served from the local machine, the remaining time until it expires is shown.

Transfer license from the Cloud Server to This Computer. Enter the number of hours for the license checkout period and press the Transfer License button. Once the license is transferred to the local machine, it will be consumed from the local server. No Internet connectivity will be required until the expiration of the license checkout.

This option is inactive (grayed out) if the license is currently served from the local machine.

Return License to the Cloud Server. Click the Return License button to switch to the Cloud Server licensing mode. This operation requires that the machine is connected to the Internet. Once the Cloud Server mode is established, the program will immediately consume a license from the Cloud Server.

This option is inactive (grayed out) if the license is currently served from the Cloud Server.

Keyboard Definitions

Description

Certain key combinations may be used as shortcuts within tnxTower. Additionally the right mouse button performs certain actions within views and spreadsheets. See the description of each view for details on mouse actions.

The right mouse toolbar button appears as 

When your mouse does not have a right button, you may use the right mouse toolbar button.

The following keyboard shortcuts are defined:

Ctrl+C	Copy currently selected item (or spreadsheet row) to the Clipboard. When copying a spreadsheet row, you must click on the row number and highlight the entire row.
Ctrl+X	Cut currently selected item (or spreadsheet row) to the Clipboard. When cutting a spreadsheet row, you must click on the row number and highlight the entire row.
Ctrl+V	Paste contents currently on the clipboard in the current item (or spreadsheet row). When pasting to a spreadsheet row, you must click on the row number and highlight the entire row to which you are pasting.
Ctrl+N	Open a New tower using the default tower configuration.
Ctrl+O	Open an existing tower.
Ctrl+S	Save the current tower.
Ctrl+P	Print hardcopy of the current view.
F1	Help
F3	Used only in the latticed pole or main tower spreadsheets. This key will “split” multiple selected rows.
F4	Used only in the feedline, discrete, dish and user forces spreadsheets. This key will toggle between “disabled” and “enabled” status when there are multiple selected rows. This allows for rapid “what-if” scenarios.
Ctrl+F3	Used only in the latticed pole or main tower spreadsheets. This key will “combine” multiple selected rows.
F8	When used in the latticed pole or main tower spreadsheets, this key will toggle the spreadsheet to full window size.
F8	Edit tower geometry. Also used in the geometry spreadsheets to switch between full screen mode and normal mode.
F9	View printed reports in Microsoft Word.

F10	Run the current tower to solution.
F11	View CHRONOS Finite Element input data
F12	View CHRONOS Finite Element input and solution data
Insert	Inserts and copies a row in a spreadsheet to the row below.

Editing Tower Data

Summary

Entering and editing tower geometry data consists of 12 dialogs all contained within a single property sheet. This command is available through the

Edit | Tower Data menu command, the **F8** key or pressing  on the toolbar.

Code Data

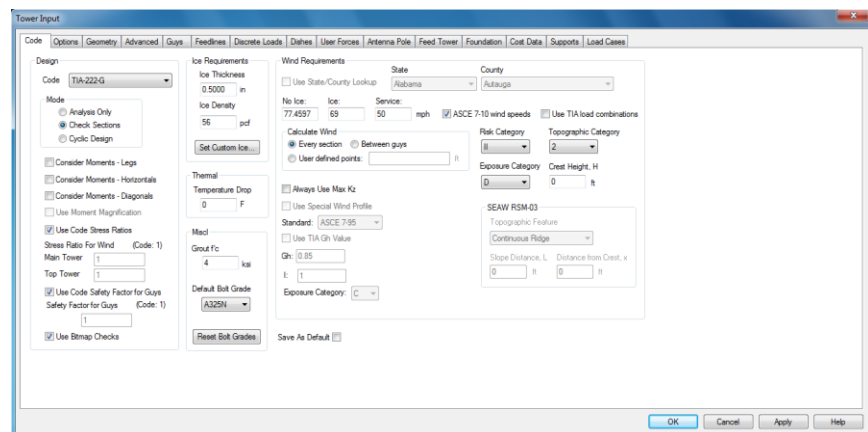

Design Code

Standard locale selection is available on the **Project** page of the **File | Settings** screen.

The current US Standard choices are:

- **RS-222** (1959). Wind pressures are described by wind “zones”, A, 30,35,40 psf), B (40,48,55 psf), or C (50,60,70 psf).
- **RS-222-A** (1966). Wind pressures are described by wind “zones”, A, 30,35,40 psf), B (40,48,55 psf), or C (50,60,70 psf).
- **RS-222-B** (1972). Wind pressures are described by wind “zones”, A, 30,35,50 psf), B (40,48,65 psf), or C (50,60,85 psf).
- **EIA-222-C** (1976). Wind pressures are described by wind “zones”, A, 30,35,50 psf), B (40,48,65 psf), or C (50,60,85 psf).
- **TIA/EIA-222-D** (1987). This Standard followed C for the United States. The D Standard introduced monopoles, but design was referred

to the ANSI/NEMA TT 1-1983 Standard. The Standard introduced many of the equations that are now contained in the 222-F Standard.

- **TIA/EIA-222-E** (1991). This Standard followed D for the United States. The E Standard introduced wind coefficients for poles; however, increased factors for step bolts were left up to the designer in a footnote. The Standard is otherwise very similar to the 222-F Standard.
- **TIA/EIA-222-F** (1996). This Standard is still used in some jurisdictions in the United States. Increased wind coefficients for step bolts on poles were made mandatory. The 222-F Standard uses the AISC ASD 9th Edition steel code for structural design.
- **ANSI/TIA-222-G** (2006). The load requirements of this Standard are based on ASCE 7-02, “Minimum Design Loads for Buildings and Other Structures”, and its design criteria are derived from AISC-LRFD-99, “Load and Resistance Factor Design Specification for Structural Steel Buildings” and ACI 318-05, “Building Code Requirements for Structural Concrete”.
- **ANSI/TIA-222-H** (2017). Wind load requirements of this Standard are based on ASCE 7-16. Steel design requirements reflect provisions of the AISC 360-16 Standard.
- **ANSI/TIA-222-I** (2023). Wind load requirements of this Standard are based on ASCE 7-22. Steel design requirements reflect provisions of the AISC 360-22 Standard.

The current Canadian Standard available is:

- **CSA-S37-01** (2001). The wind loading in this standard, expressed as a reference velocity pressure, is specified as the 30-year return period mean hourly wind pressure at 10 m above ground level. Member design provisions are generally based on the CSA-S16.1 Standard.

Design Mode

tnxTower can be run in one of three modes:

- **Analysis Only.** No steel design or checking is performed. The output will consist of forces, moments and deflections only.
- **Check Sections.** The sections that are described in the Tower Geometry data screen are stress checked.
- **Cyclic Design.** The program will run an analysis using the sections described in the Tower Geometry data screen. The program will offer a number of different choices based upon least cost and allow you to update your design choices. The program will then cycle through another analysis and design phase. This process is repeated until you are satisfied with the results or if the change in weight is less than 3%.

Other Design Options

- **Consider Moments - Legs.** When checked, bending moments in the legs will be included in the combined stress checks during steel design.
- **Consider Moments - Horizontals.** When checked, bending moments in horizontal members (except for inner bracing) will be included in the combined stress checks during steel design.
- **Consider Moments - Diagonals.** When checked, bending moments in the diagonals will be included in the combined stress checks during steel design.

- **Use Moment Magnification.** When checked, moment magnification will be considered using the familiar form: $C_M/(1-f_a/F'e)$. C_M will be calculated considering the tower as braced. Moment magnification can only be considered when one or more of the "Consider Moments" options are enabled.
- **Use Code Stress Ratios.** When checked, the program will automatically determine the appropriate allowable stress ratio from the EIA-222-C, EIA-222-D, or TIA/EIA-222-F standards. When this option is not checked, then you may enter your own values for the main tower and antenna (upper tower, or latticed pole) sections. The upper tower stress ratio will not be multiplied by the .80 factor for ground mounted latticed poles, since there is not any main supporting tower.

The Stress Ratios input can also be used to set custom utilization ratio limits for project where the passing ratio is different than 100%.
- **Use Code Safety Factor For Guys.** When checked, the program will automatically determine the appropriate allowable stress ratio from the EIA-222-C, EIA-222-D, or TIA/EIA-222-F standard. When this option is not checked, then you may enter your own value. This option is applicable only to guyed towers.

The Safety Factor input can also be used to set custom safety factor limits for project where the passing value is different than 100%.
- **Use Annex S Target Reliabilities** (TIA-222-H and I only). When checked, the program will apply the existing structure load modification factor K_{es} (Annex S, Table S-1). $tnxTower$ will not automatically apply a modified demand-capacity ratio. The user can enter the desired ratios in the appropriate Stress Ratio and Safety Factor fields.
- **Use Bitmap Checks.** $tnxTower$ will ordinarily apply a checkmark in steel design reports to sections that are OK and red X's when NG. When not checked, $tnxTower$ will not print these special symbols. Regardless, the program will print stress ratios that are overstressed in a red bold font.

Ice Requirements

This section allows you to enter the ice thickness and ice density. When these values are set to zero, then the program will make no allowance for ice.

Ice thickness may be escalated with height. The program will assume a base ice thickness that you specify. The thickness will increase with height using the ice escalation formula in the Commentary of ASCE 7-98. ASCE 7 also contains an ice thickness map of the United States.

Thermal

This section allows you to enter the temperature drop from the time that the tower is erected relative to the temperature when the ice is to be applied to the tower. For example, if the tower was erected at 70 degrees F and the ice came on the structure at 10 degrees, the drop would be 60 degrees F.

Miscellaneous

This category encompasses items various such as grout strength.

- **Grout f'c.** Specify the grout strength for grout-filled pipe.
- **Default Bolt Grade.** Specify the default grade to use for all connections when the **Reset Bolt Grades** button is pressed.

Individual bolt grades may be specified on the Advanced and Guy data entry sheets.

Wind Requirements

Wind pressures are ordinarily determined at the mid-point of every tower section (usually 20 feet in length).

On guyed towers, you may specify alternate methods to calculating the wind pressures:

- **Every Section.** The default, wind pressures are calculated using the mid-elevation of each section. This yields the most accurate wind pressure pattern.
- **Between Guy Levels.** This is the maximum spacing that the EIA standard allows.
- **User Defined Points.** You may define a list of points, separated with a comma, between which you want to have the pressure calculated. The points should be kept to less than or equal to the spacing between the guy levels.

The following example will illustrate how these different options affect the wind force.

Example: Section length is 20 feet with the bottom of the section at elevation 110 and the top at elevation 130. Guy levels are at elevation 60, 121 and 181. User defined points at 35,70,105,140 and 175. Wind velocity is 100 mph. Assume that $G_H = 1$ and $A_E = 40$ sq. ft. for the 20 foot section.

	Every Section	Between Guy Levels	User Defined Points
	Directly use mid-height of panel	Mid-height of panel falls in second guy space	Mid-height of panel falls in fourth user space
"z" Height	$(130+110)/2=120$	$(121+61)/2=91$	$(140+105)/2=122.5$
K_z	1.446	1.336	1.454
q_z	37.0	34.2	37.2
F	$37 \times 40 = 1480$	$34.2 \times 40 = 1368$	$37.2 \times 40 = 1488$

Regardless of the option that you choose, tnxTower will apply a uniform pressure over each section of the tower.

The EIA standard places limitations upon the maximum length of section over which a uniform pressure can be applied. tnxTower does not check this requirement and it is the responsibility of the user to break the tower into sections small enough to satisfy the EIA standard.

Non-guyed towers will always use the **Every Section** option.

Other wind requirements include:

- **Use State/County Lookup.** This option will enable the State and County list boxes from which you can obtain the design wind speed based upon the county listing. This option only pertains when using a design code that uses wind speed rather than pressure.

The program uses two different databases for data retrieval: under TIA-222-G the wind speed values are based on the three-second gust, for earlier codes they are based on the fastest-mile reference speed. This input is not available under TIA-222-H and I.

- **Wind Zone.** This item becomes active when using the EIA-222-C standard. Enter the wind zone, either A (30, 35,50 psf), B (40,48,65 psf), or C (50,60,85 psf). EIA-222-C uses wind pressures instead of wind velocity and therefore wind speed input will be disabled.
- **Wind Multiplier.** This item becomes active when using the EIA-222-C standard. The multiplier will modify the basic wind pressure derived from the wind zone.
- **Wind Multiplier, Ice.** This item becomes active when using the EIA-222-C standard. The multiplier will modify the basic wind pressure derived from the wind zone for the ice condition.
- **Wind Speed.** Enter the wind speed, wind speed in combination with ice, and the service load wind speed. Service load wind speed is usually taken as 50 mph for calculating deflections. Since the TIA standard allows a .75 factor on wind force in combination with ice, the wind speed with ice is typically .8666 (usually rounded to .87) times the wind speed without ice.
- **Always Use Max Kz.** Ordinarily Kz is a calculated value. When checked, the EIA maximum value for Kz will be used. This situation may occur when a tower manufacturer is designing for roof-mounted units where they want to design for the worst-case scenario.
- **Kz In Exposure D Hurricane Region (TIA-222-I only).** This option is available for Exposure Category D only. When selected, the program will use an alternative calculation for the Kz coefficient and assume an alternative Kzmin value.
- **Use Special Wind Profile.** EIA-222-F is based upon the ASCE 7-93, Exposure C wind profile. In certain regions of the country, a more stringent wind requirement is needed. When checked, choose the desired standard from the list provided: ASCE 7-88, ASCE 7-93, ASCE 7-95, ASCE 7-98, Cook County (Chicago), Illinois, Wisconsin 53 or the City of Chicago. You may also want to override the value for Gh (or have tnxTower calculate it for you), the importance factor I, and the exposure category. Please note that ASCE 7-88 and ASCE 7-93 as well as EIA-222-F use the "fastest mile" wind speed, and ASCE 7-95 and ASCE 7-98 use "3 second gust" wind speed. When switching between these standards, be sure to enter the correct wind speed from the wind speed maps contained in each standard.
- **ASCE 7-10 wind speeds (TIA-222-G only).** Wind speeds entered will be treated as ultimate values, in accordance with ASCE 7-10. In addition, the wind load and importance factors will be assumed as 1.0.
- **Use TIA load combinations (TIA-222-G only).** This checkbox is only available when the **ASCE 7-10 wind speeds** setting is on. When this option is selected, the program will convert wind speeds entered from ultimate to nominal values (as permitted by IBC 2012, 1609.1.1, Exceptions). In addition, the normal TIA-222-G load factors will be used.

- **SEAW RSM-03** (TIA-222-G only). This group of settings is available when the **Topographic Category** is set to 5. When this option is selected, the program will calculate the topographic factor K_t using the SEAW Rapid-Solutions Methodology (RSM-3). See *SEAW's Handbook of a Rapid-Solutions Methodology for Wind Design* for further information.
- **Rigorous Topographic Factor Procedure** (TIA-222-H only). This group of settings becomes active when the **Topographic Category** is set to *Rigorous Procedure*. When this category is selected, the program will calculate the topographic factor K_{zt} using Method 2 (2.6.6.2.2).
- **Consider rooftop speed-up effect** (TIA-222-H only). The user must determine whether this setting is applicable, based on the provisions of Section 2.6.7 of the Standard. Limits H_1 and H_2 are calculated automatically by the program.

Seismic Requirements

These requirements currently pertain to seismic input on the User Forces page.

- **Use ASCE 7-10 seismic load combinations** (TIA-222-G only). When this option is selected, input for vertical seismic loads E_v will be enabled on the User Forces page, and seismic load combinations will include the negative and positive E_v load values.

Tornado Loads

This input allows you to enter criteria for tornado loads to be used in generation of tornado load combinations (TIA-222-I only). The directions of tornadic winds will be as selected in the Wind Directions section on the Options input page. Since the application of tornado loads is contingent on several additional conditions (e.g., Risk Category), entering data in this section may not guarantee that tornado wind combinations will be generated.

- **Always Use Tornado Loads.** When this option is selected, the tornado loads will always be generated based on the tornado Wind Speed and Clinging Debris EPA and Height parameters. The program will ignore any additional conditions required by the Standard for consideration of the tornado loads.
- **Loads Applied: Yes/No.** The message in this box will indicate whether the tornado loads will be applied based on the entirety of the input on the Code page.
- **Wind Speed.** Enter the tornado wind speed V_T .
- **Clinging Debris - EPA.** This setting applies to lattice structures only. Enter the effective projected area of clinging debris. The program will not assume any default values for this setting.
- **Clinging Debris - Height Above Ground.** This setting applies to lattice structures only. Enter the height of the application of the clinging debris load above the ground level at the base of the tower. The program will not assume any default values for this setting.
- **Clinging Debris – Use For Tubular Poles.** The clinging debris provision in the Standard is intended for lattice structures. However, if the designer believes that a pole structure may be affected by the debris load, this option can be used. When it is selected, the program will apply the debris load to a pole section at the specified height.

Oscillations and Fatigue

This input allows you to enter criteria for generation of oscillation loads for monopoles and evaluation of shaft to base plate connections against wind dynamic effects (TIA-222-I only).

- **Run Evaluation.** When this option is selected, the program will generate load combinations for along-wind gust and vortex shedding analyses, as appropriate, and evaluate the shaft to base plate connection for fatigue loads. Please note that the load combinations may not be generated, or the evaluations may not be performed if relevant model parameters do not fall within ranges stipulated in the Standard.
- **Structural Damping Ratio.** Enter the structural damping ratio for the first mode of vibration ζ_s .
- **Auto-determine analysis type.** When this option is selected, the program will attempt to determine which oscillation analysis types are applicable for the current model. This determination is based on maximum areas of external appurtenances only and does not include consideration of the distribution the appurtenances along and around the pole, or wind directionality.
- **Select manually analysis type.** This setting group is active when the **Auto-determine analysis type** checkbox is unselected. It allows to select either or both the **Along-Wind Gust** and **Vortex Shedding** analyses.
- **Fatigue Detail Component Item.** Select the desired fatigue evaluation Item number from the drop-down list. See Table 4-11 in TIA-222-I for numbers and descriptions of Component Items.
- **Do Not Run Evaluation.** If this option is selected, the user must choose the reason for not running the evaluation from the drop-down list. The available options are:

Evaluation not required. The oscillations load combinations will not be generated if, in the user's judgement, the analysis is not required.

Use modified Gh in lieu of evaluation. This option may be selected for existing monopoles as permitted by Section 15.7 of TIA-222-I. No oscillations load combinations will be generated, but an alternative value of the gust effect factor Gh will be used.

- **Clinging Debris - Height Above Ground.** This setting applies to lattice structures only. Enter the height of the application of the clinging debris load above the ground level at the base of the tower. The program will not assume any default values for this setting.
- **Clinging Debris - Height Above Ground.** This setting applies to lattice structures only. Enter the height of the application of the clinging debris load above the ground level at the base of the tower. The program will not assume any default values for this setting.
- **Clinging Debris - Height Above Ground.** This setting applies to lattice structures only. Enter the height of the application of the clinging debris load above the ground level at the base of the tower. The program will not assume any default values for this setting.

CAN-S37-01 Input

Switching to the Canadian S37 Standard Series on the **Project** page of the **File | Settings** screen enables entry of S37-specific data. The following input is available:

- **Reference Velocity Pressure.** 30-year return mean hourly value, at 10 m above ground level. Min. 300 Pa.
- **Always Use Max. Ce.** The Height Factor C_e depends on the height of a tower section above grade. For projects where the ultimate location of the tower cannot be determined, using the maximum value provides a conservative way of accounting for all possible construction scenarios.
- **Reliability Class.** Settings for class I, II, and III, corresponding to Importance Factors γ of 1.0, 0.9, and 0.8, respectively.
- **Serviceability Factor.** Reflects the annual permissible signal degradation. If not specified in project requirements, it should be taken as 1.0.

Save As Default

When you want to save this tower configuration as the default, then check this box. The default will be generated whenever you use **File | New**. The default tower is saved in the Defaults directory.

General Options

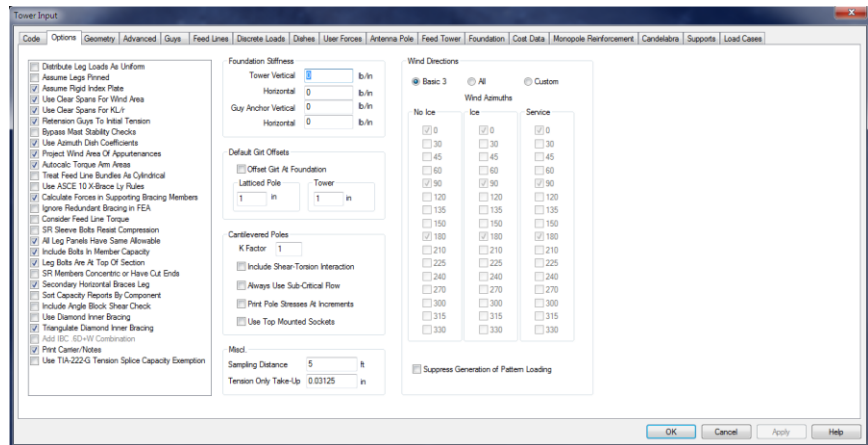

These settings include:

- **Distribute Leg Loads As Uniform.** tnxTower calculates the percentage that the legs are of the total section gross area. The non-leg loads are ordinarily distributed as nodal loads at the point where diagonals intersect the legs, and the leg portion of the wind is applied as uniform load. When checked all section wind loads are applied as uniform load on the legs.
- **Assume Legs Pinned.** Normally, legs are modeled just as they are built, as continuous members. When checked, the program will pin the legs members where feasible. Note that some continuity may be required for stability. In addition, when diagonal offsets are specified, this feature will automatically be ignored since continuity is required to resist the secondary moment generated from diagonal offsets.
- **Assume Rigid Index Plate.** Index plates provide a load transfer interface between tower sections of different sizes. When the index plate is assumed rigid, all node points on that surface are joined by a rigid-body relationship. As an alternative, the program will provide stiff framing members to provide the load transfer mechanism. Note that in some rare cases, very stiff members may create an ill-conditioned stiffness matrix, which may fail to solve.
- **Use Clear Spans For Wind Area.** Normally tnxTower will use the center-to-center length between nodal coordinate points to determine wind areas. When a tower has large diameter legs, this will result in an overly conservative calculation for wind area for members that frame into the leg. When this option is checked, the program will adjust the wind areas to account for the actual clear span of members that frame into the legs. This option will be ignored when connection offsets are specified. Note that the reports will still show the length as being the center-to-center dimension. Only the wind area is adjusted for the clear span.
- **Use Clear Spans For Kl/r.** Normally tnxTower will use the center-to-center length between nodal coordinate points to determine Kl/r ratios. When a tower has large diameter legs, this will result in an

overly conservative calculation for Kl/r for members that frame into the leg. When this option is checked, the program will adjust the L_u length to account for the actual clear span of members that frame into the legs. This option will be ignored when connection offsets are specified. Note that the reports will still show the length as being the center-to-center dimension. Only the L_u length is adjusted for the clear span.

- **Retension Guys To Initial Tension.** In multi-level guyed towers, the initial tension in lower guys will be reduced as each subsequent level above it is stressed during construction. The result is that the lowest level of guys, which might have been specified to 10% initial tension, will only effectively have 8-9%. Check this if you want all of the guys to have full initial tension after all tensioning has taken place (re-tensioning).
- **Bypass Mast Stability Checks.** Normally this option would only be used for guyed towers where buckling of the entire mast may occur between guy levels. Check this if you want to ignore (unconservative) the mast stability check. See the Technical Appendix for a derivation of this technique. The mast stability index will decrease the allowable axial compression stress in the event that the overall stability of the tower is more critical than the individual element stability. This option also controls whether or not axial buckling will be checked for poles, both cantilevered, latticed poles and ground-mounted monopoles.
- **Use Dish Azimuth Coefficients.** When checked, the program will calculate the drag coefficients based upon the angle that the wind vector makes with the dish aiming azimuth. When not checked, or if the offset setting is None, the program will use the worst case coefficients, which assumes that the dish is always aimed into the wind.
- **Project Wind Area of Appurtenances.** When checked, the program will project the front and side areas of discrete appurtenances onto the plane of the wind. The program will use the technique outlined in the Technical Appendix to project the area front and side areas. When projection is turned off, or if the appurtenance has an offset setting of None, then the greater of the front or side face area will be used for all wind directions. Note that this differs from version 1.0, which only used the front face area for all wind directions.
- **Use Alternative Appurtenance EPA Calculation.** When checked, the program will use formulas shown in the Projection of Discrete Appurtenance Areas section of the Technical Appendix for the calculation of the Discrete Loads EPA. Otherwise, the relevant TIA-222 EPA formulas will be used.
- **Automatic Torque Arm Areas.** When checked, the program will automatically calculate the $CaAa$ of torque arms in guyed towers. Otherwise, you must enter the torque arm $CaAa$ into the Discrete Appurtenance spread sheet. When not checked, you must manually calculate the torque arm area and enter it as a discrete load.
- **Treat Feed Line Bundles As Cylindrical.** When checked, the program will calculate feed line bundle area as the lesser of the sum of the individual line areas or a cylinder that encompasses the entire bundle. This option is ignored when the code is set to TIA-222-G or TIA-222-H. See the technical appendix for a discussion on how the feed line bundle areas are calculated.

- **Use ASCE 10 X-Brace Ly Rules.** When checked, the program will use the L1+.5L2 for out-of-plane buckling of X-bracing in accordance with Figure of the TIA Standard and the ASCE 10 Standard. When this option is not checked, the program uses the assumption, based upon recent research, that the out-of-plane is braced at the cross over point.
- **Calculate Forces in Supporting Bracing Members.** When checked, the program will calculate redundant bracing forces to be a minimum of 1.5% (1.5% - 2.5% under TIA-222-G or TIA-222-H) of the force in the supported member.
- **Ignore Redundant Bracing in FEA.** Most redundant bracing is originally designed to brace main members in the tower and is not designed to otherwise participate as full structural members. When checked, the redundant members will not transmit forces from the main members except for the calculated bracing force if Calculate Redundant Bracing Forces option is checked.
- **Consider Feed Line Torque.** When checked, the program will allow for offsetting feed lines within the tower face. The program will then calculate an equivalent center of pressure for each section of the tower. Refer to the Feed Line Load Data chapter for information on how this is accomplished. When this option is unselected, the program will not calculate the global torque (due to feed line tributary wind load) and overturning moment (due to feed line dead load).
- **SR Sleeve Bolts Resist Compression.** When checked, bolts in solid round sleeve type leg connections will resist both compression and tension. This is the default and is the way the PiRod connections are manufactured. When un-checked, the bolts will only resist tension and will assume that the solid round resists compression through bearing of the leg members.
- **All Leg Panels Have Same Allowable.** This has been the default since v1.0 of tnxTower was released. In this system, the largest panel length is used to establish a critical KL/r for all legs within the tower section. When this option is un-checked, then each leg member has it's KL/r calculated using the actual length of the panel. Of course, the KL/r of the mast (for guyed towers) may control over either option.
- **Include Bolts In Member Capacity.** When checked, the member's capacity rating will reflect the bolt stress rating as well as the member's own stress rating. When not checked, the bolt capacity is kept separate.
- **Leg Bolts Are At Top Of Section.** When checked, leg flange or sleeve connections will be assumed to occur at the top of each section. When unchecked, the connection will be at the bottom of each section.
- **SR Members Concentric and/or Have Cut Ends.** Solid round members that have cut ends will have their K factors calculated in a different manner than members that are continuous and bent over (Table 4-5, TIA-222-G and TIA-222-H). When X-Bracing is used, members are concentric at intersection point.
- **Secondary Horizontal Braces Leg.** Secondary horizontals ordinarily are not considered to be able to brace leg members. When the secondary horizontals are sufficiently triangulated to have this capability, then you may check this box.

- **Sort Capacity Reports By Component.** Normally the capacity reports are sorted first by tower section number, then by component (leg, diagonal, etc.). This option will sort the capacity reports first by component and then by tower section number.
- **Include Angle Block Shear Check.** When checked, the program will perform an approximate block shear capacity check for angle members using a single line of bolts. A standard minimum end distance will be assumed along with a bolt spacing of 3 diameters. The tension length will be assumed to be the greater of the edge distance or the depth of the member minus the usual gage length.
- **Use Diamond Inner Bracing.** This option pertains to four sided towers only. When checked, the program will install diamond pattern inner bracing at top and bottom girt locations. Otherwise, the program will generate an X pattern unless the tower bracing type is one of the K-brace types.
- **Triangulate Diamond Inner Bracing.** This option pertains to four sided towers only. When this option and the Use Diamond Inner Bracing options are checked, the diamond pattern inner bracing will have an additional member that triangulates the diamond pattern.
- **Add IBC .6D+W Combination.** When checked, the program will create additional load combinations for the IBC 2000 load combination of 60% Dead + Wind. This combination was included to IBC to account for uplift and overturning resistance. This option would most likely not be used for guyed towers.
- **Print Carrier/Notes.** When checked, the program will create printed reports and material take-off plots that contain the Carrier/Notes that you have entered on the Feedline, Discrete and Dish spreadsheets.
- **Use TIA-222 Bracing Resistance Exemption.** When checked, the program will not enforce certain provisions of Section 4.4.1 of the Standard, in accordance with Section 15.6 (TIA-222-G) or 15.7 (TIA-222-H).
- **Use TIA-222 Leg Tension Splice Exemption.** When checked, the program will not enforce certain provisions of Section 4.9.7 of the Standard, in accordance with Section 15.6 (TIA-222-G) or 15.7 (TIA-222-H).
- **Ignore KL/ry For 60 Deg. Angle Legs.** When checked, the program will not consider the KL/ry ratio for schifflerized angle and 60 deg. bent plate legs in staggered bracing patterns. Under TIA-222-H the y-y slenderness ratio for such legs is always ignored (Table 4-3), and this option has no effect.

Cantilevered Poles

K-Factor. Enter the K-factor that will apply to top mounted latticed poles or ground mounted poles. This only applies when mast stability checks are used. P-delta non-linear analysis should always be used for poles. In this case, a value of K=1 over the entire pole height might be considered.

A strict interpretation of the TIA standard regarding monopoles would have the K-factor set to 0, the Bypass Mast Stability checked, and Include Shear-Torsion Interaction un-checked. The TIA standard considers local buckling only for monopoles as long as a non-linear analysis is performed.

Always Use Sub-Critical Flow. When poles contain a substantial amount of appurtenances, or if the pole is being strengthened by welding stiffeners to the

outside of the pole, super-critical flow may not be achievable. In these cases, you can force the program to use the C_F for sub-critical flow by checking the box.

Include Shear-Torsion Interaction. When checked, the combination of axial, bending, shear and torsion will be included in design checks for monopoles. Otherwise, only AISC axial and bending checks will be made

A strict interpretation of the TIA standard regarding monopoles would have the K-factor set to 0, the Bypass Mast Stability checked, and Include Shear-Torsion Interaction is un-checked. The TIA standard considers local buckling only for monopoles as long as a non-linear analysis is performed.

Print Pole Stresses At Increments. When checked, the stress tables will be created at increments along each pole section. When this option is not checked, then only the maximum stress in the section will be printed.

Use Top Mounted Sockets. Ordinarily, pole sockets are supported at the bottom of the pole socket. When checked, the pole will be supported at the top of the socket where the pole penetrates the tower index plate.

Pole Without Linear Attachments (TIA-222-H only). Calculations of the force coefficient C_f will be based on Table 2-8b of the Standard. It is assumed that the pole has no linear attachments, other than step bolts and a safety cable.

Pole With Shroud Or No Appurtenances (TIA-222-H only). This option should be selected for tubular poles that support appurtenances enclosed entirely within a cylindrical shroud, or for tubular poles without any appurtenances.

Outside And Inside Corner Radii Are Known (TIA-222-H only). This setting pertains to calculations of wind loads (outside radius) and effective yield stress (inside radius) for polygonal tubular poles. The inside bend radius is entered on the Geometry page. The outside corner radius is assumed to be the inside radius plus the wall thickness.

The force coefficient C_f may be reduced if the outside corner radius of the pole is known, in accordance with Table 2-8c.

If this setting is selected, C_f will be reduced, if applicable, as per Table 2-8c.

If this setting is not selected, the provisions of Table 2-8c will be ignored.

In the calculation of the effective yield stress ($F'y$), the flat side dimension (w) may be based on the inside corner radius greater than 1.5 times the wall thickness ($1.5*t$) if the value of the radius is known (Table 4-8).

If this setting is selected, the program will determine w based on the inside radius entered on the Geometry page. However, if the radius value entered exceeds 4 times the wall thickness ($4*t$), the program will use $4*t$ for the calculation of w .

If this setting is not selected, the program will determine w based on the inside radius equal to $1.5*t$.

Select this option if you know the outside and inside corner radius values of the pole.

Tension Only Systems

Specify the amount, usually in inches, that the tension-only members will be tightened. A common take-up value would be 1/32 to 1/16 inch, although most users will probably want to keep this value blank (0). Take-up imparts a pre-stressing force into the tension-only diagonals and is used only in combination with TX-Bracing (tension-only X bracing).

Critical Rotation Reports

Critical rotation reports will print out the deflection, tilt, twist and radius of curvature at all dish, user force, and discrete loading points. Radius of curvature is calculated using three points on the tower. The distance between these points is known as the sampling distance. A number between 5 and 10 feet is usually specified.

Girt Offsets

This is the default amount that the girts are offset from the end of each section, usually from 1 to 12 inches. This distance will only be applied where sections are joined to another section that also has a girt at that location and you have left the girt offset (specified on the Geometry spreadsheet) as 0. There are separate entries for the latticed pole portion and the main tower portion. The actual offsets can be adjusted when entering the section information.

Offset Girt At Foundation. Usually the bottom girt at the foundation is not offset since there isn't any section below it. Check this box so that the bottom girt at the foundation will be offset.

Foundation Stiffness

Foundations are usually assumed rigid, that is they cannot settle or displace under load. When the tower or guy foundations are attached to a flexible foundation, and the stiffness of the foundation can be determined, then the user may enter both a vertical and/or horizontal stiffness for the foundation. Stiffness is ignored when a value of 0 is entered in the field.

The stiffness of a spread footing can be approximated by using the modulus of sub-grade reaction, k_s . The stiffness would be $B \times L \times k_s$, where B is the width and L is the length of the footing. The table below, taken from Bowles, shows some typical values:

Soil	k_s , kcf
Loose sand	30-100
Medium dense sand	60-500
Dense sand	400-800
Clayey medium dense sand	200-500
Silty, medium dense sand	150-300
Clay, $q_u < 4$ ksf	75-150
Clay, $4 < q_u < 8$ ksf	150-300
Clay, $q_u > 8$ ksf	>300

Calculating the stiffness of a drilled pier (caisson) is difficult as it is a function of skin friction, end bearing and stiffness of the concrete pier as a column. Pile programs that can determine the vertical deflection can be used to evaluate k. The stiffness is the vertical load applied divided by the vertical deflection.

Wind Directions

Basic 3. The program will use only three directions of wind. Wind normal (azimuth 0), wind 60 (azimuth 180) and wind 90 (azimuth 90). These are equivalent to the directions used in version 1.0 of tnxTower. When using diagonal up bracing schemes, you should also consider wind 270 since this direction would produce the worst case for diagonal compression.

All. The program will analyze all possible directions of wind as required by the EIA/TIA Standard. This option will result in the longest analysis time.

Custom. Using this option, you may specify which directions of wind that you wish to analyze.

Suppress Generation of Pattern Loading. This option pertains only to input for TIA-222-G or TIA-222-H. When checked, the program applies uninterrupted wind loads. As each load pattern is part of a separate load combination, using this option reduces the analysis and design time and may be useful at the preliminary stage.

Geometry Data

The screenshot shows the 'Tower Input' window with the following parameters:

- Tower Type: 3x Guyed Tower
- Overall Height: 1139.90 ft
- Tower Face Width: 8.00 ft
- Base Face Width: 8.00 ft
- Latticed Pole Width: 3.00 ft
- Has index plate:
- Autocalc Gh:
- LAMBDA: 10.76 ft
- Latticed Pole Type: 3 Sided
- Elevation of Base: 1.00 ft
- Base Type: Taper
- Base Taper Height: 11.00 ft
- Height For User Gh: 1139.90 ft
- Use Gh = 1.35 for upper pole:
- Top takeup on lambda:

Below the parameters are two data tables:

	Latticed Pole Height Above Base (ft)	Number Of Sections	Database	Assembly Name	Section Length (ft)	Diagonal Spacing (ft)	Bracing Type	Has K-Brace End Panels	Has Horizontals	Leg Type
1	1139.90	3	prod	#36 109319	20.00	2.333	X Brace	No	Steps	Solid Round
2										
3										
4										
5										
6										
7										
8										
9										
10										

	Tower Height Above Base (ft)	Number Of Sections	Database	Assembly Name	Section Length (ft)	Top Face Width (ft)	Diagonal Spacing (ft)	Bracing Type	Face Bevel (in/20°)	Has K-Brace End Panels	Has Horizontal
1	1079.90	1			13.90	8.00	4.833333	K Brace Down	0	No	Yes
2	1069.00	1			7.50	8.00	7.50	K Brace Down	0	No	Yes
3	1058.50	1			30.00	8.00	7.50	K Brace Down	0	No	Yes
4	1028.50	1			22.50	8.00	7.50	K Brace Down	0	No	Yes
5	1006.00	1			7.50	8.00	7.50	K Brace Up	0	No	Yes
6	998.50	1			7.50	8.00	7.50	TX Brace	0	No	Yes
7	991.00	1			30.00	8.00	10.00	TX Brace	0	No	Yes
8	961.00	1			30.00	8.00	10.00	TX Brace	0	No	Yes
9	931.00	1			30.00	8.00	10.00	TX Brace	0	No	Yes
10	901.00	1			30.00	8.00	10.00	TX Brace	0	No	Yes

General Tower Data

The general tower data needs to be entered before entering section-by-section information. The tower is made up of a base (main) tower and an optional upper-latticed pole tower. You may also have an upper-latticed pole tower without a base tower. This would be the case if you had a ground-mounted pole (pipe section). Inner feed towers (tower sections running inside of the main tower which support their own feed lines) are entered in the Feed Tower Data section.

Tower Type

Some of the basic types of towers are shown below.

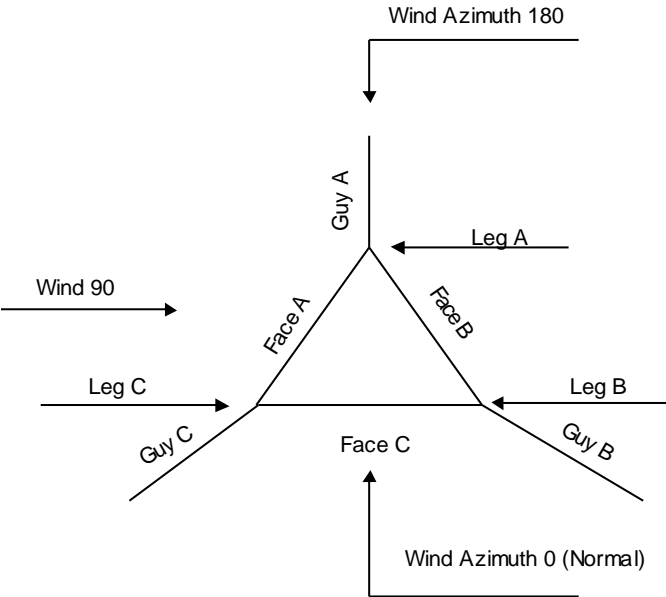

Corner & Starmount Guyed & Self Supporter

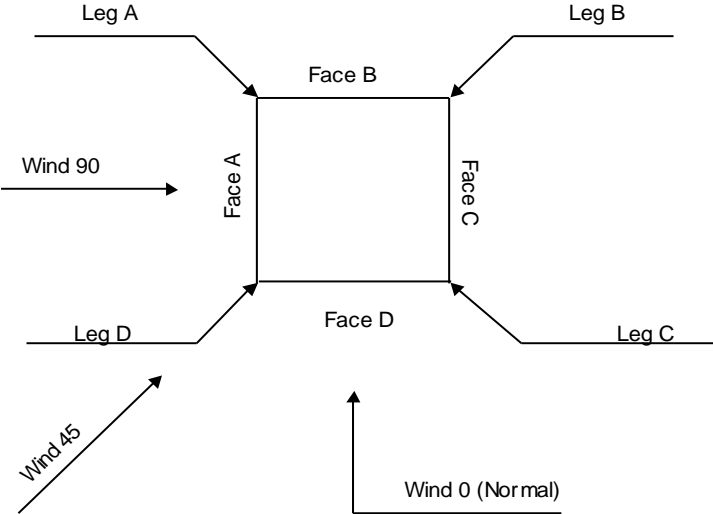

Square Tower

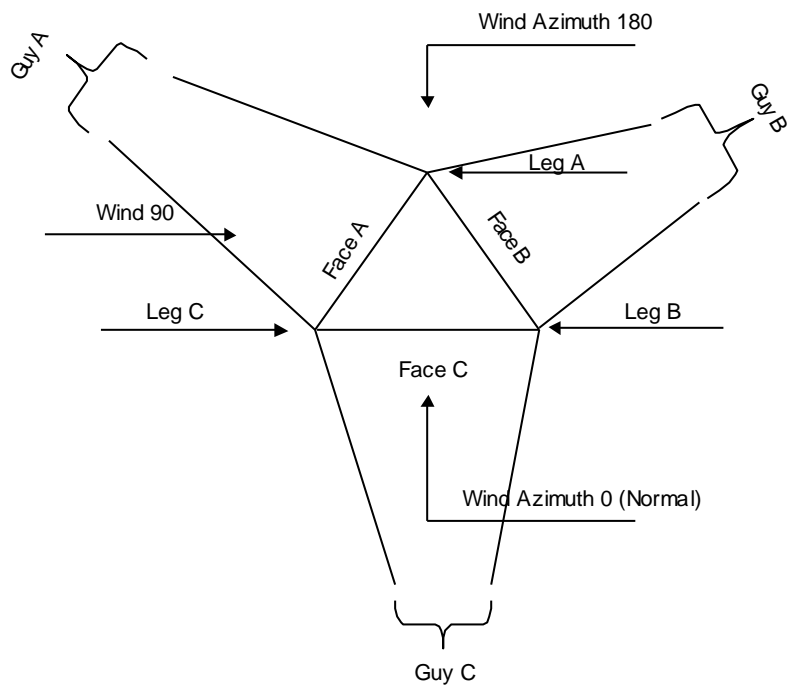

Face Guyed

Choose one of the following types for the base (main) tower:

- **3 Sided Guyed Tower** A 3-sided tower with one or more levels of guys. The face width may vary but most guyed towers have a constant face width.
- **4 Sided Guyed Tower** A 4-sided tower with one or more levels of guys. The face width may vary but most guyed towers have a constant face width.
- **3 Sided Tower** A freestanding 3-sided tower. The face width may vary, usually getting wider toward the base of the tower.
- **4 Sided Tower** A freestanding 4-sided tower. The face width may vary, usually getting wider toward the base of the tower.

For ground mounted poles, choose 3 sided or 4 sided depending on how many faces you want to have for locating dishes and feed lines. For monopoles that are to be reinforced with guys, choose 3 or 4-sided guyed tower as the base tower type.

Latticed Pole Type

Latticed pole are usually meant for antenna mount and are situated on top of the base tower. Choose one of the following types for the upper tower:

- **3 Sided Tower** A 3-sided tower of constant face width.
- **4 Sided Tower** A 4-sided tower of constant face width.

- **Pole** A circular pipe section that may be stepped to differing face widths.
- **Tapered Pole.** A tapered multi-faceted pipe of 8,12,16, or 18 sides.

Overall Height

Enter the height of the tower from the base to the top. This should not be confused with the elevation of the top of the tower.

Elevation of Base

Enter the elevation of the base of the tower above grade. For example, if a tower were built upon the roof of a 200 foot building, the elevation would be 200 feet.

Base Type

Enter the type of base that the tower is to have. All base types are torsionally fixed.

- **I-Beam** The legs extend down to an I-beam base that pivots on a single point support. No overturning moment fixity is assumed; however, the based will be torsionally fixed to account for pin friction.
- **I-Beam Free** The legs extend down to an I-beam base that pivots on a single point support and the pin will be torsionally free to rotate.
- **Taper** The bottom section of the tower will taper to a single point support. No overturning moment fixity is assumed; however, the based will be torsionally fixed to account for pin friction.
- **Taper Free** The bottom section of the tower will taper to a single point support and the pin will be torsionally free to rotate.
- **None** The legs of the tower extend to the ground and are assumed to be pinned for moment.

Tapered bases have very little shear resistance and, as a result, a guyed tower analysis may diverge during solution. Should this happen, you should try changing the base type to I-Beam with a tower base width of 12 inches.

Taper Height

Enter the section length for a **Taper** or **Taper Free** base. Not applicable to any other base type.

I-Beam Pivot Dist

Enter the distance from the I-beam base to the pivot point. This is applicable to guyed towers with I-beam bases only. The overall height of the tower includes the pivot distance.

Tower Face Width

Enter the face width for top of the base (main) tower. When there is a latticed pole on top of the base tower, the face width must be large enough to accommodate the lattice pole without the latticed pole extending over the sides of the base tower. The face width is the center-to-center (centroidal axis) of the leg member.

Base Face Width

Enter the face width for the bottom of the tower. When the base face width is not equal to the tower face width, the tower will have beveled (tapered) sides. The face width is the center-to-center (centroidal axis) of the leg member.

Latticed Pole Width

Enter the face width for the latticed pole. A latticed pole (not applicable to circular poles) always has a constant face width. When there is a base tower below the latticed pole, the face width must be small enough to fit within the width of the base tower. The face width is the center-to-center (centroidal axis) of the leg member.

Constant Slope

When the base tower has a constant slope (bevel) you may check this box and the program will automatically calculate the face width of each section.

Autocalc Gh

When checked the value of Gh will be automatically calculated from the overall height of the tower or the height of the base tower when the top tower is a pole. When not checked, you may enter your own height from which to calculate Gh or enter pre-calculated values of Gh.

Enter pre-defined Gh values

Available only under TIA-222-G or TIA-222-H. This option allows users to set the gust effect factor Gh to any pre-calculated value, separately for the base tower and the upper structure, if present. Different tower components will have the "Base Tower" or "Upper Structure" Gh value applied in accordance with the following rules:

Items entered in lower spreadsheet -	Base Tower
Items entered in upper spreadsheet -	Upper Structure
Monopoles (upper spreadsheet) -	Upper Structure
Antennas entered on Antenna Pole page -	Upper Structure

Pole is ground mounted

When checked, the pole structure will be designed using the gust effect factor Gh applicable to monopoles for tubular structures. Otherwise, the Gh is calculated for the value in the "Height for User Gh" box, or arbitrary values of Gh are used if the "Enter pre-defined Gh values" option is selected.

Height for User Gh

Applicable only when **Autocalc Gh** or **Enter pre-defined Gh values** (TIA-222-G and TIA-222-H only) are not checked. Gh will be calculated from this height. Note the Gh is calculated using the height of the structure, not the elevation of the top of the structure when mounted on a roof top.

Gust Effect Factor Cg (CSA-S37)

The Cg factor modifies the wind pressure to account for 3-5s wind velocity spikes and dynamic effects. It is independent of the height of the structure.

Use default Cg values. Gust Effect Factors are taken as 2.0 for lattice structures and 2.5 for pole structures. Cg for the lower and upper spreadsheets will be set to 2.0 if both define lattice structures. If the upper spreadsheet defines a pole upper structure or the tower is a monopole, the Cg for the upper structure will be set to 2.5.

Enter pre-defined Cg values. In some circumstances the user may wish to modify the default Cg values (e.g., for pole structures meeting the requirements of Clause 4.6.2 of CSA-S37-01). The custom Cg values may be entered separately for the Base Tower and the Upper Structure (or monopole).

Has Index Plate

An index plate is a steel plate or a grillage of beams that form a platform when the top tower does not have the same width as the base tower and the same number of legs. When not checked, the top face width of the tower is set to be the latticed pole width and will taper down to the tower face width one section down. Under TIA-222-G and TIA-222-H this option automatically sets the Gh for the upper structure to 1.35 (tubular) or 1.1 (lattice).

Generating Latticed Pole Data

Creating a latticed pole is accomplished by using a spreadsheet for data entry. The latticed pole is assumed to be a constant width as described in Latticed Pole Width. To delete any row, you may click on the row number and hit the delete key. Inserting a row below the current is done in the same manner except that you key the insert key. When a row is inserted, the current row is copied down to the newly inserted row. Deleting or inserting multiple rows may be accomplished by clicking and dragging the mouse up or down, or by using the shift or ctrl keys in combination with the left mouse button. Copying, cutting and pasting may be accomplished by selecting the row and then using Ctrl+C (to copy), Ctrl+X (to cut) and Ctrl+V (to paste). The F8 function key can be used to toggle between the normal spreadsheet size and a window-maximized size.

When there is no latticed pole on the structure, then leave all the rows blank in this spreadsheet control.

The entire spreadsheet is wider than the screen allows. You must use the horizontal scroll bar found at the bottom of the spreadsheet control to scroll to the right and enter additional information.

	Latticed Pole Height Above Base (ft)	Number Of Sections	Database	Assembly Name	Section Length (ft)	Diagonal Spacing (ft)	Bracing Type	Has Horizontals	
1	654.000	1			2.568	2.568	X Brace	No	Sc
2	651.432	1			20.456	2.557	X Brace	No	Sc
3	630.976	1			20.456	2.557	X Brace	No	Sc

Latticed Pole Height Above Base

This column is read-only and is calculated by the program as you enter in section data.

Number of Sections

Enter the number of sections that are to be identical. The design program will design all of the sections on this row of the spreadsheet to satisfy the worst-case member. In other words, all diagonals in all of the sections described by this row will be designed or checked with the same member size.

Splitting Sections

When you entered more than one for the number of sections, and later want to create individual sections, then right click anywhere in the row and the program will *split* the section into multiple sections. For example, if you had entered 5 – 20 foot sections and you choose to split the row, the program will reenter 5 separate rows with the number of sections set to 1 each with a 20 foot length. You may also split multiple rows. First select the rows you want to split by clicking on the row numbers using Shift, Ctrl or dragging the mouse to highlight the rows. Then hit the F3 special function key. All of the highlighted rows will then be split.

You may also split a section into sub-panels. Just as in splitting multiple sections, first select the row, the right click. Only sections that do not contain k-braced ends and mid girts may be split into sub-panels.

Combining Sections

When you have several identical rows that you would like to combine into a single row, select the rows you wish to combine by using Shift, Ctrl or dragging the mouse to highlight the rows. Then hit the CTRL+F3 special function key. All of the highlighted rows will then be combined into a single row.

Database

When you had previously created a database of pre-configured tower assemblies and you want to pull an assembly from a database, then choose the database from the list. Leave the database name blank if you want to manually enter the tower section geometry.

Assembly Name

When you had previously created a database of pre-configured tower assemblies and you want to pull an assembly from a database, then choose the proper database and then choose an assembly from the list shown. Leave the assembly name blank if you want to manually enter the tower section geometry.

Section Length

Enter the length of the section. In the United States, this is usually 20 feet.

Lattice Pole Diagonal Spacing

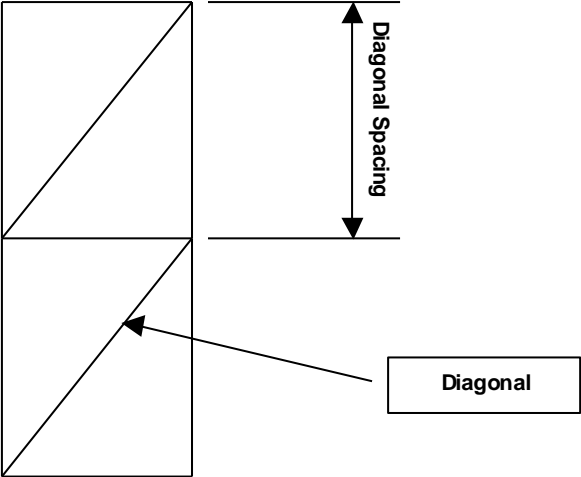

**Lattice Pole Bracing
Types**

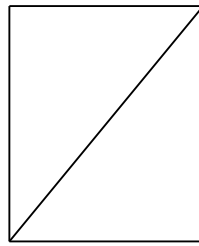

**Diagonal Up
Z-Brace**

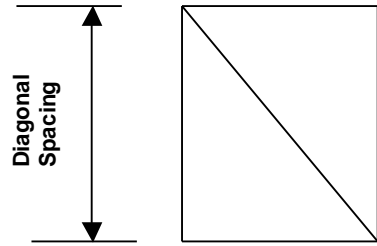

Diagonal Down

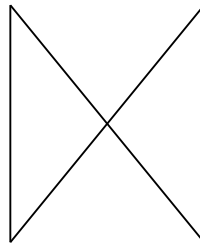

**X-Brace (Stitch Plate)
CX-Brace (No Stitch Plate)**

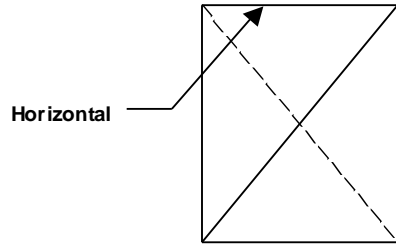

TX-Brace (Tension Only)

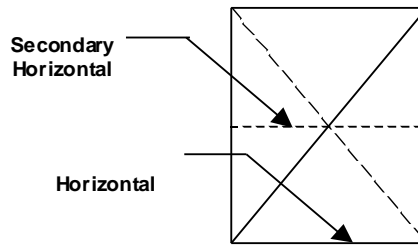

CX, TX-Brace with Secondary Horizontal

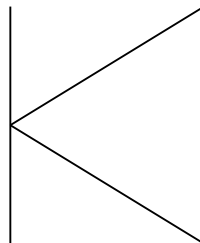

K-Brace Right

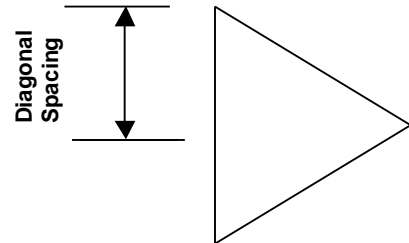

K-Brace Left

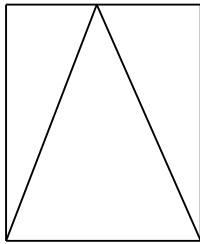

K-Brace Down
TK-Brace Down (Tension-Only)

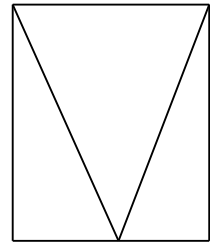

K-Brace Up
TK-Brace Up (Tension-Only)

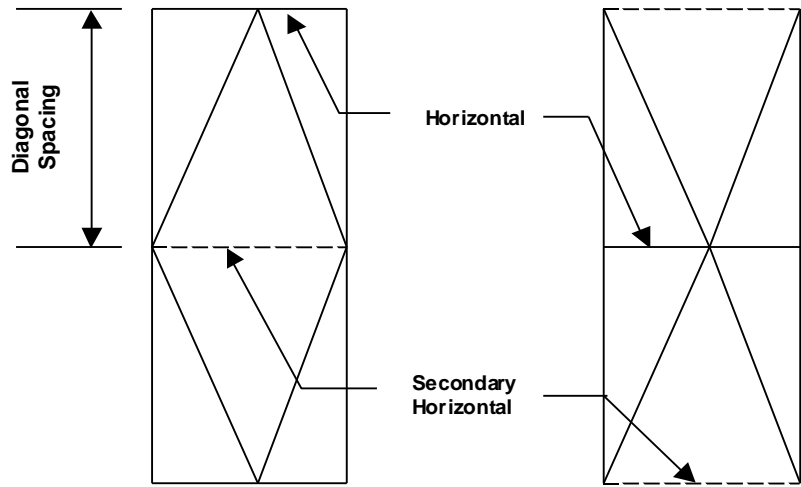

Diamond

Double K

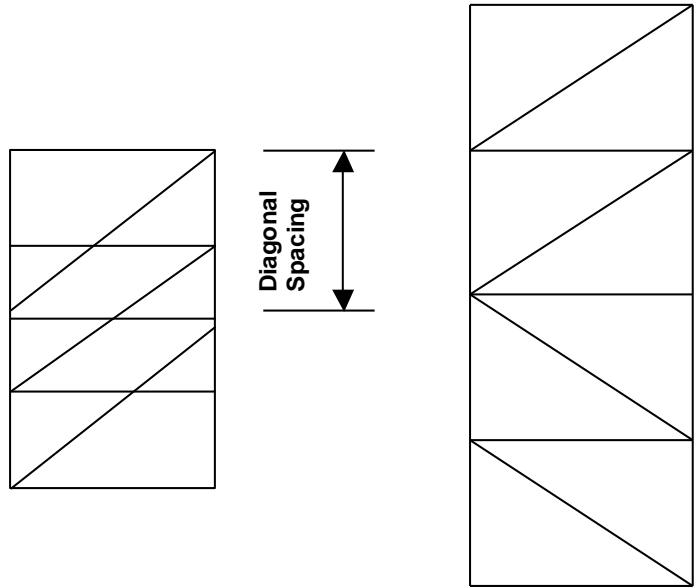

Z - Rohn 65

M - Bracing

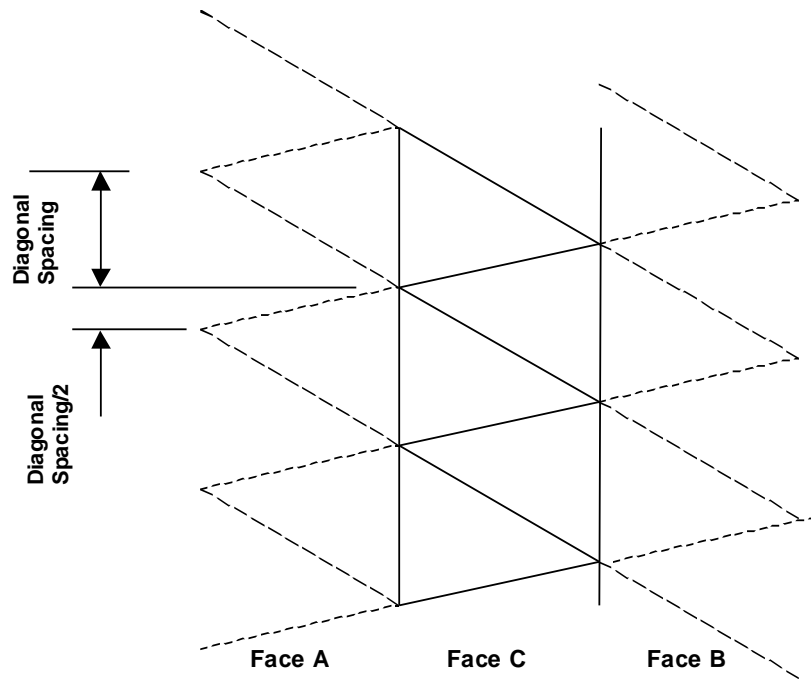

Gtasis (Andrew) M46 Double Slope - Bracing

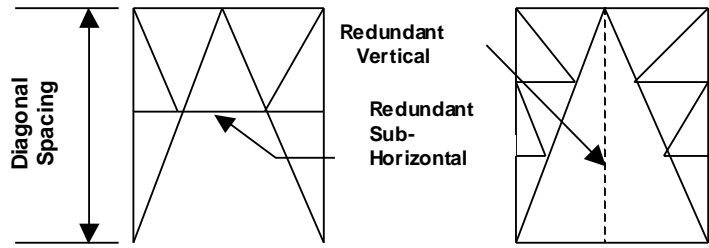

**K1 Down
K1 Up (Opposite)**

**K2 Down
K2 Up (Opposite)**

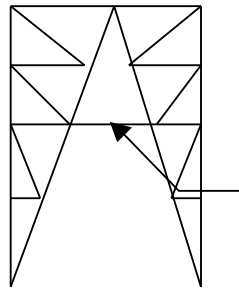

**K3 Down
K3 Up (Opposite)
K4 Similar (4 Panels)**

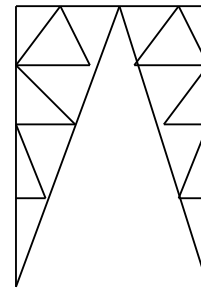

**K3A Down
K4 Up (Opposite)
K4A Down Similar (4 Panels)**

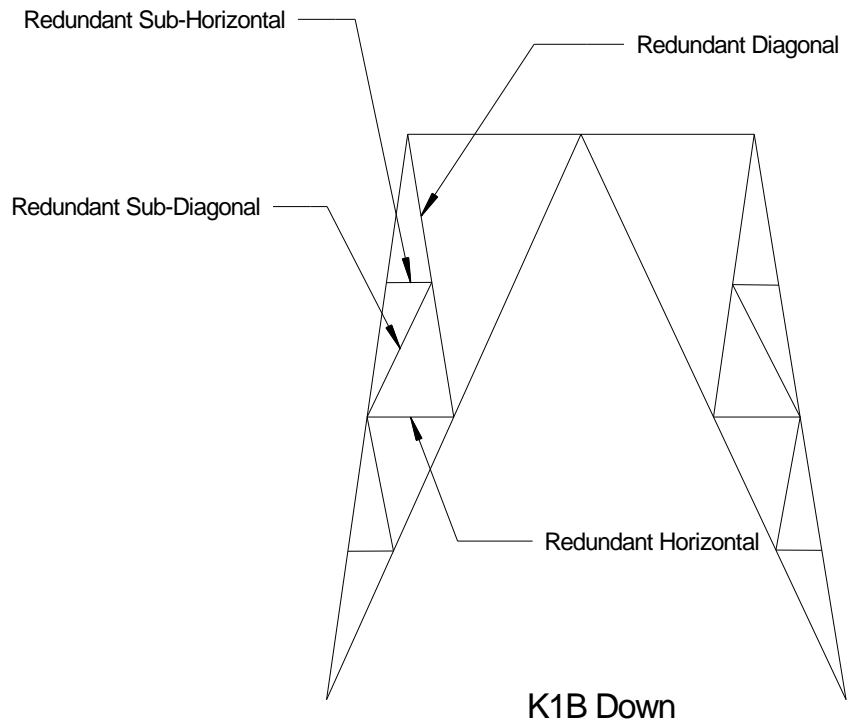

K1B Down

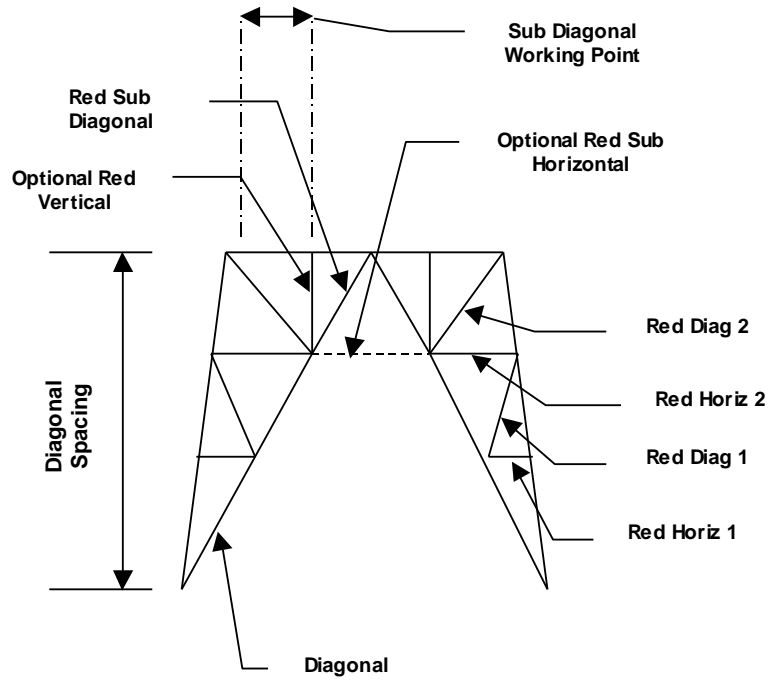
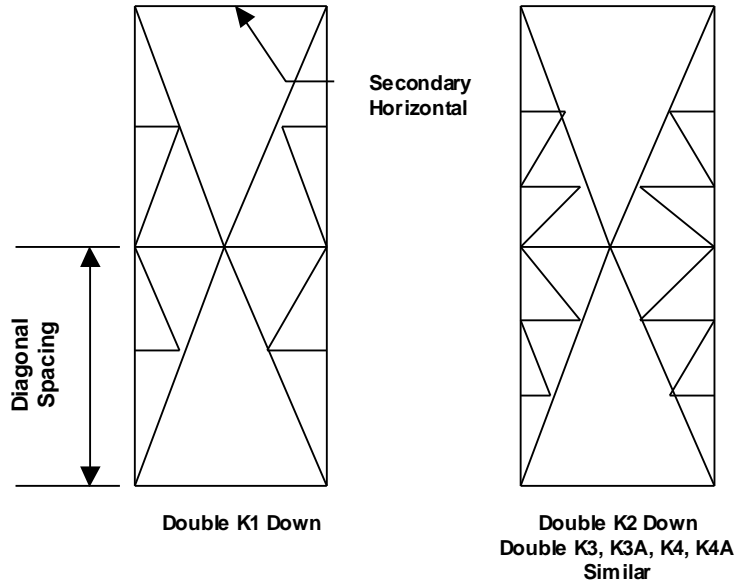

Cranked K Bracing

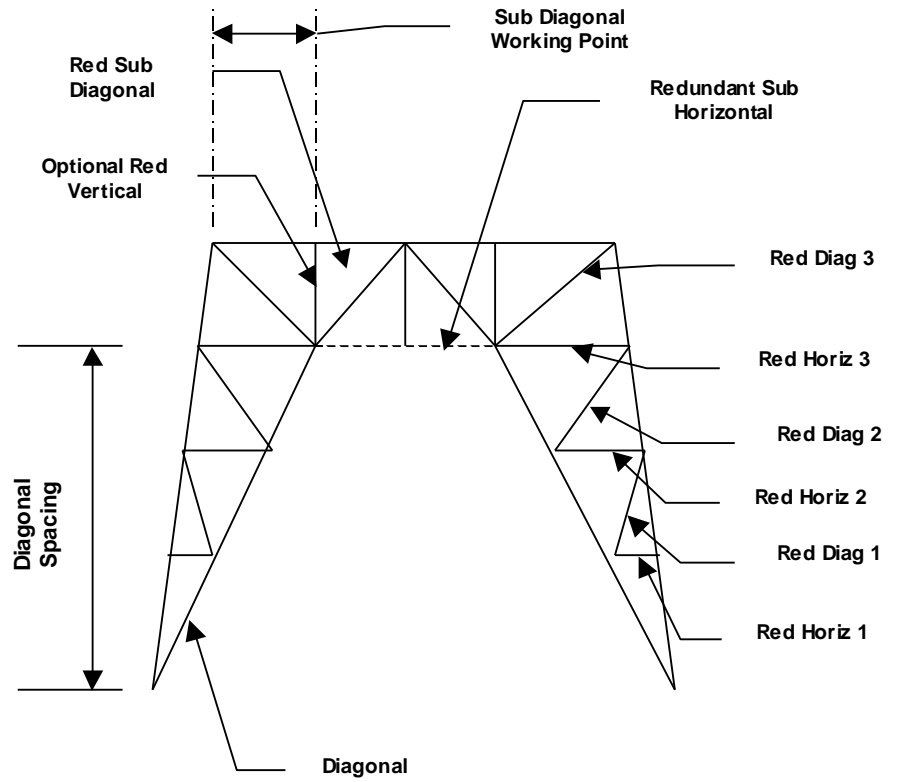

Cranked K2 Bracing

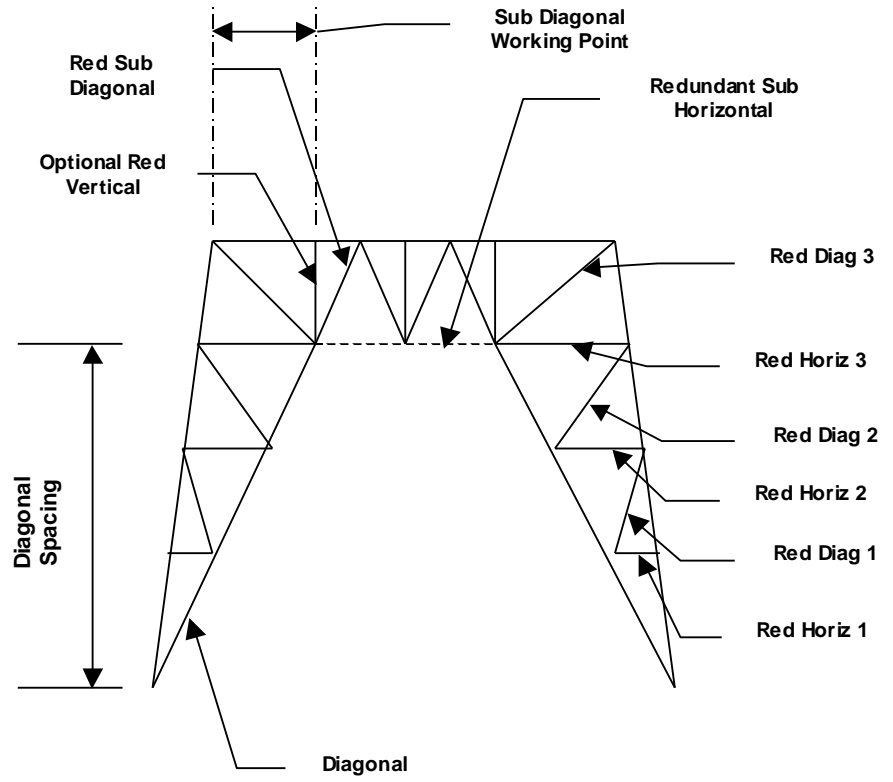

Portal Bracing

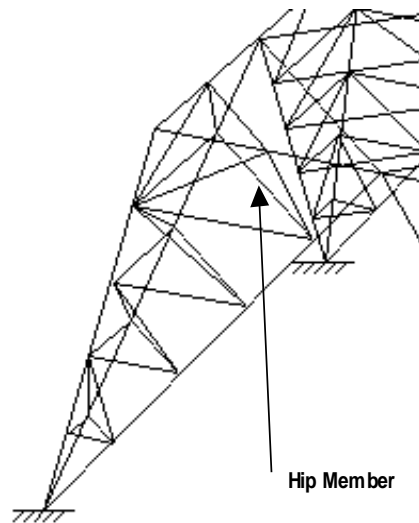

Hip Bracing

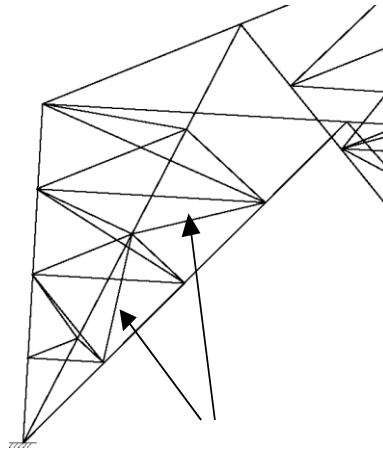

Hip Diagonal Member

Hip Bracing - diagonals

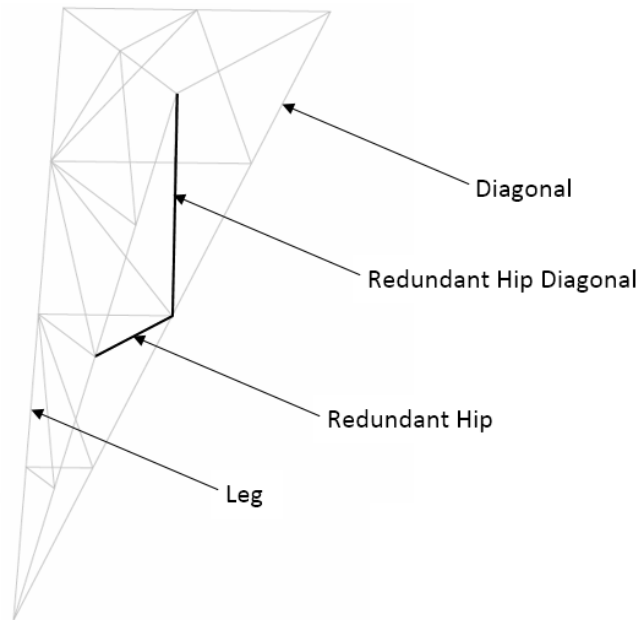

K3A M Down Bracing

K3A M Down Bracing is a special case of the K3A Down pattern, where the hip member braces the diagonals at mid-span only.

Lattice Pole Has K-Brace End Panels

The Z-Brace and Z-Rohn 65 types are special forms of diagonal up bracing. The diagonal type, size and grade in these types will automatically be copied to the horizontal type, size and grade. Z-Rohn 65 also will have the diagonal information copied to the top and bottom girt information.

Some manufacturers place a half-panel of k-bracing at the ends of each section. This is known as k-brace end panels. Enter **Yes** if there are K-braced end panels in the section, otherwise **No**.

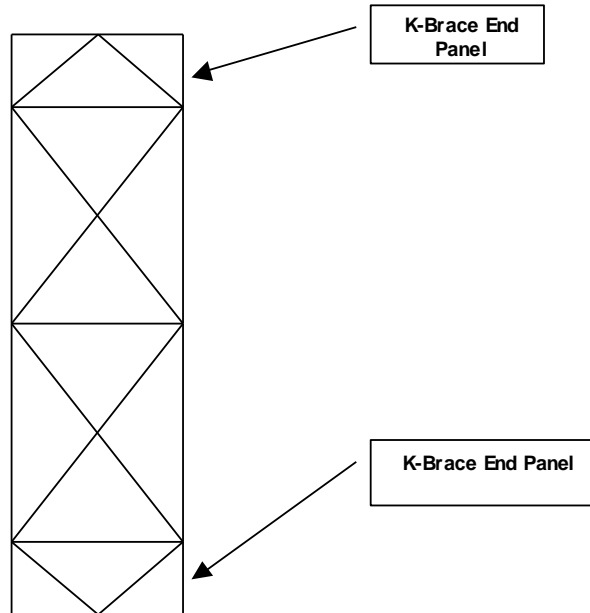

Lattice Pole Has Horizontals

Horizontals can be of the following types:

- **Guy Pull-Off.** Specified in the Guy Data spreadsheet, these occur at points where guys or torque arms meet the tower.
- **Top or Bottom Girt.** These horizontals occur at the far ends of the tower section.
- **Mid Girt.** Some tower manufacturers break up their sections in sub-sections, placing a mid-girt at the end of each sub-section.
- **Horizontal.** The main horizontal members that are in the section everywhere except at the far ends.
- **Secondary Horizontal.** Used for step members and for auxiliary horizontals used for reducing tower leg bracing distances (KL) when used with the Secondary Horizontal Braces Leg Option.

Horizontal types higher in the hierarchy will over ride horizontals that are lower in the hierarchy. For instance, a girt will always replace a horizontal, and a guy pull-off will over ride any other horizontal type.

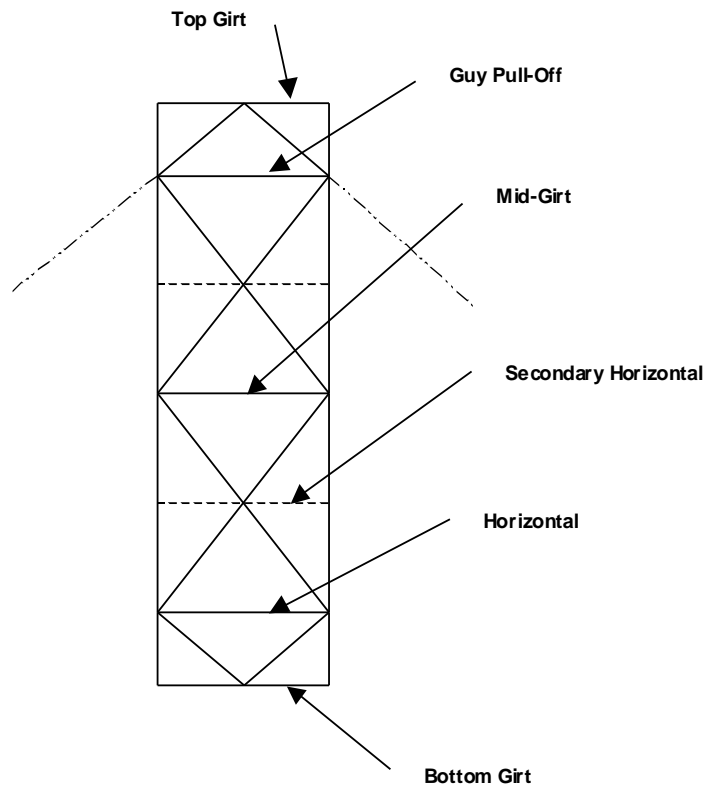

Enter the type of horizontals to be generated:

- **No.** Horizontals are not generated for diamond and double-k bracing types as shown by dashed line in the bracing type figure. See Bracing Type.
- **Yes.** Horizontals (secondary horizontal size) are generated for diamond. Double-K, X, CX and TX bracing types are shown by dashed lines in the bracing type figure. See Bracing Type.
- **Yes+Steps.** Steps (secondary horizontal size) are generated in the front face only. TX and CX bracing do not allow for steps since the diagonals bypass one another. Horizontals are generated in all faces.

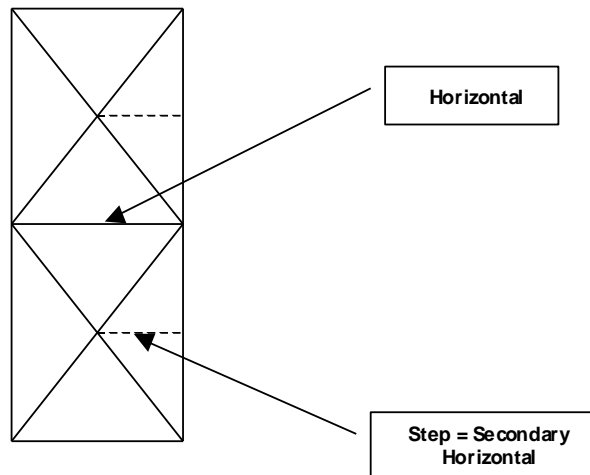

- **Steps.** Steps (secondary horizontal size) are generated in the front face only. TX and CX bracing do not allow for steps since the diagonals bypass one another. See Bracing Type.

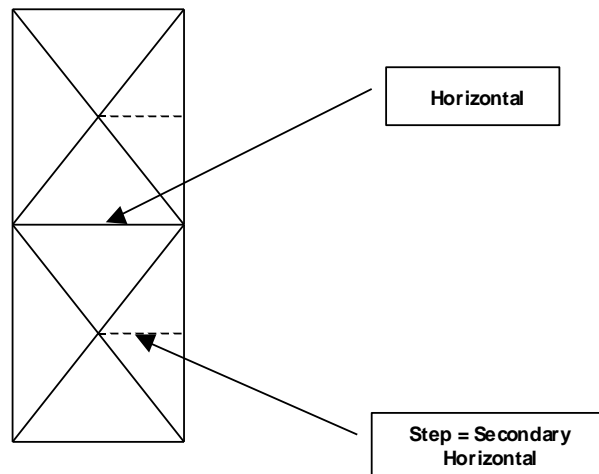

Leg Type

Select the steel shape type for the leg members. Choices are limited to those shapes that are installed with the application. Standard types are angles, solid rounds and pipe.

Leg Size

Select a size for the steel leg member from the choices found in the list box. You may add or restrict which shapes by using the Database Editor.

Leg Grade

Enter the grade for the leg steel. Common values are A36 or A572-50.

Diagonal Type

Select the steel shape type for the diagonal members. Choices are limited to those shapes that are installed with the application. Standard types are angles, double angles, channels, solid rounds and pipe.

Diagonal Size

Select a size for the steel diagonal member from the choices found in the list box. You may add or restrict which shapes by using the Database Editor.

A special type of framing is generated when the diagonal size is left blank. A Vierendeel frame will be created between the leg and horizontal members in the section.

Diagonal Grade

Enter the grade for the diagonal steel. Common values are A36 or A572-50.

Top Girt Offset

Enter the amount that the top girt will be offset. The offset can be important in the checking of leg bolts. Please refer to the Technical Appendix.

Bottom Girt Offset

Enter the amount that the bottom girt will be offset. The offset can be important in the checking of leg bolts. Please refer to the Technical Appendix.

Top Girt Type

Top and bottom girts occur only at the far ends of each section. They are offset from the ends by the amount of the **Girt Offset**. See Girt Offsets.

Select the steel shape type for the top and bottom girt members. Choices are limited to those shapes that are installed with the application. Standard types are angles, double angles, channels, solid rounds and pipe.

Top Girt Size

Select a size for the steel top girt member from the choices found in the list box. You may add or restrict which shapes by using the Database Editor. When there is no top girt members, just leave the field blank. An exception occurs at the very top of the tower where a girt is required. When the girt is left blank in this instance, a girt the same size as the diagonal will be inserted automatically.

Top Girt Grade

Enter the grade for the top girt. Common values are A36 or A572-50.

Bottom Girt Type

Top and bottom girts occur only at the far ends of each section. They are offset from the ends by the amount of the **Girt Offset**. See Girt Offsets.

Select the steel shape type for the top and bottom girt members. Choices are limited to those shapes that are installed with the application. Standard types are angles, double angles, channels, solid rounds and pipe.

Bottom Girt Size

Select a size for the steel bottom girt member from the choices found in the list box. You may add or restrict which shapes by using the Database Editor. When there is no bottom girt members, just leave the field blank.

Bottom Girt Grade

Enter the grade for the bottom girt. Common values are A36 or A572-50.

Number of Mid Girts

Mid girts occur evenly spaced between the top and bottom girts. When the number is set to zero, it is assumed that there are no mid girts.

Mid Girt Type

Select the steel shape type for the mid girt members. Choices are limited to those shapes that are installed with the application. Standard types are angles, double angles, channels, solid rounds and pipe.

Mid Girt Size

Select a size for the steel mid girt member from the choices found in the list box. You may add or restrict which shapes by using the Database Editor. When there are no mid girt members, just leave the field blank.

Mid Girt Grade

Enter the grade for the mid girts. Common values are A36 or A572-50.

Horizontal Type

Select the steel shape type for the horizontal members. Choices are limited to those shapes that are installed with the application. Standard types are angles, double angles, channels, solid rounds and pipe.

Horizontal Size

Select a size for the steel horizontal member from the choices found in the list box. You may add or restrict which shapes by using the Database Editor. When there are no horizontal members, just leave the field blank.

Horizontal Grade

Enter the grade for the horizontals. Common values are A36 or A572-50.

Secondary Horizontal Type

Select the steel shape type for the secondary horizontal members. Choices are limited to those shapes that are installed with the application. Standard types are angles, double angles, channels, solid rounds and pipe.

Secondary Horizontal Size

Select a size for the steel secondary horizontal member from the choices found in the list box. You may add or restrict which shapes by using the Database Editor. When there are no secondary members, just leave the field blank. Secondary horizontals are used in Diamond, Double K, X, CX and TX bracing types. These members are assumed not to be triangulated and therefore do not have sufficient strength to brace leg members unless the Secondary Horizontal Braces Leg Option is used.

Secondary Horizontal Grade

Enter the grade for the secondary horizontals. Common values are A36 or A572-50.

Inner Bracing Type

Select the steel shape type for the inner bracing members. Choices are limited to those shapes that are installed with the application. Standard types are angles, double angles, channels, solid rounds and pipe.

Inner Bracing Size

Select a size for the steel inner bracing member from the choices found in the list box. You may add or restrict which shapes by using the Database Editor. When there is no inner bracing members, just leave the field blank.

Inner Bracing Grade

Enter the grade for the inner bracing steel. Inner bracing consists of supporting members in the horizontal plane. Common values are A36 or A572-50.

Redundant Bracing Type

Select the steel shape type for the redundant bracing members. Choices are limited to those shapes that are installed with the application. Standard types are angles, double angles, channels, solid rounds and pipe. Redundant members are designed for 1.5% of the axial compressive load in the member, which the redundant braces.

Redundant Bracing Grade

Enter the grade stress for the redundant bracing steel. Common values are A36 or A572-50. Redundant bracing consists of supporting members in K1, K2, K3, K2A, K3A, K4, K4A, Cranked K and Portal bracing types.

Redundant Horizontal Type

Select the steel shape type for the redundant horizontal bracing members. Choices are limited to those shapes that are installed with the application. Standard types are angles, double angles, channels, solid rounds and pipe. Redundant members are designed for the force in the brace or 1.5% of the axial compressive load in the member that the redundant braces.

Redundant Horizontal Size (1-4)

Select a size for the steel redundant horizontal bracing members from the choices found in the list box. You may add or restrict which shapes by using the Database Editor. Redundant bracing consists of supporting members in K1, K2, K3, K4, K2A, K3A, K4A, Cranked K and Portal bracing types.

In the K1 bracing type, the redundant horizontal may be left blank, leaving only the diagonal as the brace. This is a common situation in Andrew self-supporting towers. The braces are numbered 1 through 4 beginning at the bottom of the panel.

Redundant Diagonal Type

Select the steel shape type for the redundant diagonal bracing members. Choices are limited to those shapes that are installed with the application. Standard types are angles, double angles, channels, solid rounds and pipe. Redundant members are designed for the force in the brace or 1.5% of the axial compressive load in the member that the redundant braces.

Redundant Diagonal Size (1-4)

Select a size for the steel redundant diagonal bracing members from the choices found in the list box. You may add or restrict which shapes by using the Database Editor. Redundant bracing consists of supporting members in K1, K2,

Redundant Sub Diagonal Type

K3, K4, K2A K3A, K4A, Cranked K and Portal bracing types. The braces are numbered 1 through 4 beginning at the bottom of the panel.

Select the steel shape type for the redundant sub diagonal bracing members. This type is only used in Cranked K or Portal bracing schemes. Choices are limited to those shapes that are installed with the application. Standard types are angles, double angles, channels, solid rounds and pipe.

Redundant Sub Diagonal Size

Select a size for the steel redundant sub diagonal bracing members from the choices found in the list box. This type is only used in Cranked K or Portal bracing schemes. You may add or restrict which shapes by using the Database Editor.

Redundant Sub Diagonal Working Point

This is only used in Cranked K or Portal bracing schemes. Enter the fraction of the face width where the main diagonal and sub-diagonal meet.

Redundant Sub-Horizontal Type

Select the steel shape type for the redundant sub-horizontal bracing members. Choices are limited to those shapes that are installed with the application. Standard types are angles, double angles, channels, solid rounds and pipe. Redundant members are designed for the force in the brace or 1.5% of the axial compressive load in the member that the redundant braces.

Redundant Sub-Horizontal Size

Select a size for the steel redundant sub-horizontal bracing members from the choices found in the list box. You may add or restrict which shapes by using the Database Editor. Redundant bracing consists of supporting members in K1, K2, K3, K4, K2A K3A, K4A, Cranked K and Portal bracing types.

Redundant Vertical Type

Select the steel shape type for the redundant vertical bracing members. Choices are limited to those shapes that are installed with the application. Standard types are angles, double angles, channels, solid rounds and pipe. Redundant members are designed for the force in the brace or 1.5% of the axial compressive load in the member that the redundant braces.

Redundant Vertical Size

Select a size for the steel redundant vertical bracing members from the choices found in the list box. You may add or restrict which shapes by using the Database Editor. Redundant vertical bracing consists of supporting members in K-Down, Double-K, K1, K2, K3, K4, K2A K3A, K4A, Cranked K and Portal bracing types. A redundant vertical cannot exist at the same time a redundant sub-horizontal exists.

Redundant Hip Type

Select the steel shape type for the redundant hip bracing members. Choices are limited to those shapes that are installed with the application. Standard types are angles, double angles, channels, solid rounds and pipe. Redundant members are designed for the force in the brace or 1.5% of the axial compressive load in the member that the redundant braces.

Redundant Hip Size (1-4)

Select a size for the steel redundant hip bracing members from the choices found in the list box. Hip bracing is horizontal bracing that runs between the redundant horizontals on each adjacent face of the tower. You may add or restrict which shapes by using the Database Editor. Redundant bracing consists of supporting members in K1, K2, K3, K4, K2A K3A, K4A, Cranked K and Portal bracing types. When the hip size is left blank, the main diagonal in the panel will be unbraced for the entire length about its y-axis. The braces are numbered 1 through 4 beginning at the bottom of the panel.

Redundant Hip Diagonal Size

Select a size for the steel redundant hip diagonal bracing members from the choices found in the list box. Hip diagonal bracing is lacing that runs between the redundant hips and the main diagonals on the adjacent faces of the tower. You may add or restrict which shapes by using the Database Editor. Redundant bracing consists of supporting members in K2, K3, K4, K2A K3A, K4A, Cranked K and Portal bracing types.

Adding A Latticed Pole To A Tower That Previously Had None

Follow these steps to add a latticed pole to a tower that did not have one previously:

- Change the over height of the tower to account for the pole height. After doing this, you will notice that the program has added sections to the bottom of the base tower to account for this change in height. Ignore this for now.
- Choose the latticed pole type
- Enter the latticed pole face width
- Go to the latticed pole spreadsheet control and enter your data. As you enter the number of sections and section length, you will notice that the program will automatically delete any sections at the base of the tower that it previously had created.
- When you entered the pole properly, you should see no new sections at the base of the main tower.
- To delete the entire latticed pole and start over again, select all of the spreadsheet rows in the latticed pole section. Then hit the delete key.

Generating Circular Pole Data

	Pole Height Above Base (ft)	Section Length (ft)	Pole Type	Pole Size	Pole Grade	Socket Length (ft)
1	148.000	37.000	Pipe	P8x.406	A139-45	3.750
2	111.000	40.000	Pipe	P8x.406	A139-45	4.750
3	71.000	40.000	Pipe	P8x.406	A139-45	5.500
4	31.000	31.000	Pipe	P8x.406	A139-45	0.000

Create a circular pole by selecting **Pole** as a latticed pole type. Poles are assumed to be a circular pipe. The spreadsheet control will change as shown above.

Section Length Pole Type

Enter the length of the section. In the United States, this is usually 20 feet.

Enter the type of section, either Pipe or Arbitrary. An arbitrary section allows the modeling of reinforced sections.

Pole Size

Select a size for the steel pole member from the choices found in the list box.

Pole Grade

Enter the grade for the pole steel. A common value is A180-45. The -45 indicates that the yield stress is 45 ksi.

Socket Length

The socket is only valid for the bottom section. The socket length is the amount that the pole is extended down into the base tower. Ground mounted poles have no bottom socket length. Likewise, if the socket length is left blank, and there is a base tower, an index plate will be provided automatically at the top of the base tower.

Generating Tapered Pole Data

	Pole Height Above Base (ft)	Section Length (ft)	Lap Splice Length (ft)	Number of Sides	Top Diameter (in)	Bottom Diameter (in)	Wall Thickness (in)	Bend Radius (in)	Taper
1	148.000	37.000	3.750	18	22.000	29.586	0.21875	0.875	A:
2	114.750	40.000	4.750	18	29.3796486	36.590	0.250	1.000	A:
3	79.500	40.000	5.500	18	35.1062083	43.307	0.3125	1.250	A:

Create a tapered pole by selecting **Tapered Pole** as a latticed pole type. Tapered poles currently can only be checked. They cannot be designed from a database of shapes. Tapered poles can be 18, 16, 12 or 8 sided. The spreadsheet control will change as shown above.

Section Length

Enter the length of the section. Sections usually come in approximately 40' lengths.

Splice Length

The splice length is defined to be the amount of the pipe that is telescoped over the section below it. This is usually between 1.5 to 2 times the diameter of the pole.

Number of Sides

Select the number of sides the pipe has, 18, 16, 12 or 8.

Top Diameter

Enter the diameter (across the flats) of the pipe at the top most pipe of the section. The top diameter is entered only for the top section and is automatically calculated for all other sections.

Bottom Diameter

Enter the diameter (across the flats) of the pipe at the bottom most pipe of the section.

Wall Thickness

Enter the wall thickness of the pipe. The program assumes a constant wall thickness is each section.

Bend Radius

Enter the bend radius (usually about 4 times the wall thickness) of the pipe. The radius pertains only to 16-sided pipe.

Pole Grade

Enter the grade for the pole steel. A common value is A572-65. The -65 indicates that the yield stress is 65 ksi.

Generating Base Tower Data

	Tower Height Above Base (ft)	Number of Sections	Database	Assembly Name	Section Length (ft)	Top Face Width (ft)	Diagonal Spacing (ft)	Bracing Type
1	250.000	1			10.000	2.500	2.500	X Brace
2	240.000	1			20.000	2.500	2.500	X Brace
3	220.000	4			20.000	2.500	2.500	X Brace
4	140.000	1			20.000	2.500	2.500	X Brace
5	120.000	2			20.000	2.500	2.500	X Brace

Creating a base tower is accomplished by using a spreadsheet for data entry. To delete any row, you may click on the row number and hit the delete key. Inserting a row below the current is done in the same manner except that you key the insert key. When a row is inserted, the current row is copied down to the newly inserted row. Deleting or inserting multiple rows may be accomplished by clicking and dragging the mouse up or down, or by using the shift or ctrl keys in combination with the left mouse button. Copying, cutting and pasting may be accomplished by selecting the row and then using Ctrl+C (to copy), Ctrl+X (to cut) and Ctrl+V (to paste). The F8 function key can be used to toggle between the normal spreadsheet size and a window-maximized size.

When there is no base tower on the structure, then leave all the rows blank in this spreadsheet control.

The entire spreadsheet is wider than the screen allows. You must use the horizontal scroll bar found at the bottom of the spreadsheet control to scroll to the right and enter additional information.

Tower Height Above Base

This column is read-only and is calculated by the program as you enter in section data.

Number of Sections

Enter the number of sections that are to be identical. The design program will design all of the sections on this row of the spreadsheet to satisfy the worst-case member. In other words, all diagonals in all of the sections described by this row will be designed or checked with the same member size.

Splitting Sections

When you entered more than one for the number of sections, and later want to create individual sections, then right click anywhere in the row and the program will *split* the section into multiple sections. For example, if you had entered 5 – 20 foot sections and you choose to split the row, the program will generate 5

separate rows with the number of sections set to 1 each with a 20 foot length. You may also split multiple rows. First select the rows you want to split by clicking on the row numbers using Shift, Ctrl or dragging the mouse to highlight the rows. Then hit the F3 special function key. All of the highlighted rows will then be split.

You may also split a section into sub-panels. Just as in splitting multiple sections, first select the row, the right click. Only sections that do not contain k-braced ends and mid girts may be split into sub-panels.

Combining Sections

When you have several identical rows that you would like to combine into a single row, select the rows you wish to combine by using Shift, Ctrl or dragging the mouse to highlight the rows. Then hit the CTRL+F3 special function key. All of the highlighted rows will then be combined into a single row.

Database

When you had previously created a database of pre-configured tower assemblies and you want to pull an assembly from a database, then choose the database from the list. Leave the database name blank if you want to manually enter the tower section geometry.

Assembly Name

When you had previously created a database of pre-configured tower assemblies and you want to pull an assembly from a database, then choose the proper database and then choose an assembly from the list shown. Leave the assembly name blank if you want to manually enter the tower section geometry.

Section Length

Enter the length of the section. In the United States, this is usually 20 feet.

Face Width

Enter the face width at the top of the section.

Diagonal Spacing

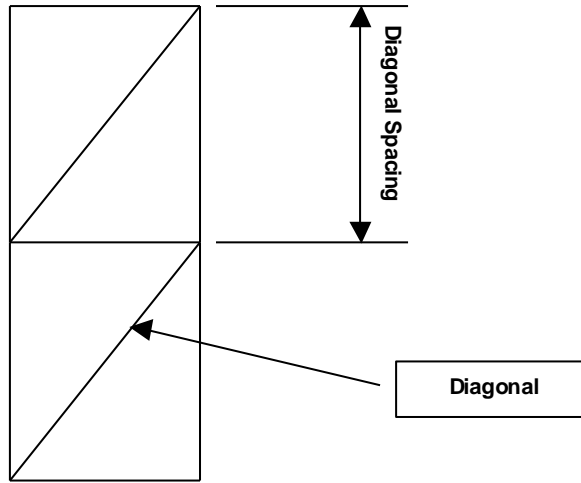

Bracing Type

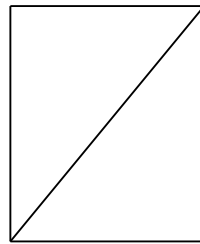

Diagonal Up
Z-Brace

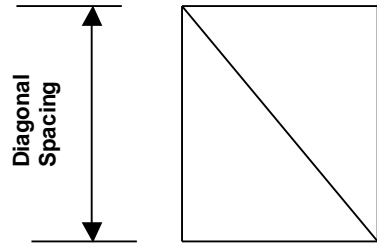

Diagonal Down

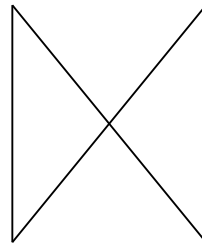

X-Brace (Stitch Plate)
CX-Brace (No Stitch Plate)

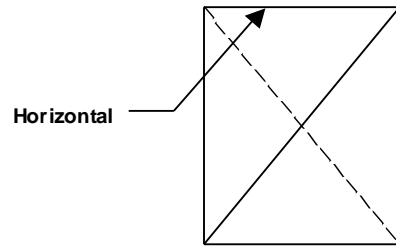

TX-Brace (Tension Only)

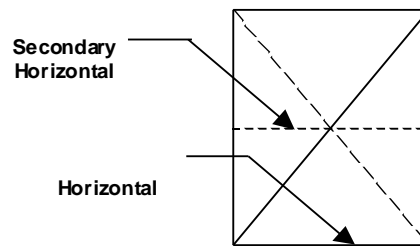

CX, TX-Brace with Secondary Horizontal

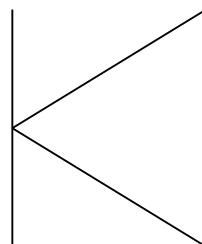

K-Brace Right

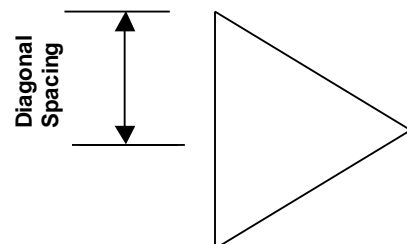

K-Brace Left

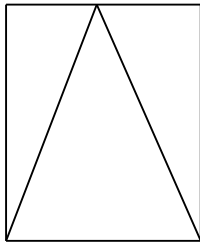

K-Brace Down
TK-Brace Down n (Tension Only)

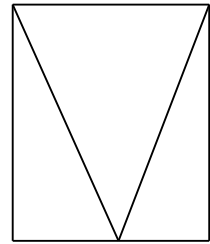

K-Brace Up
TK-Brace Up (Tension Only)

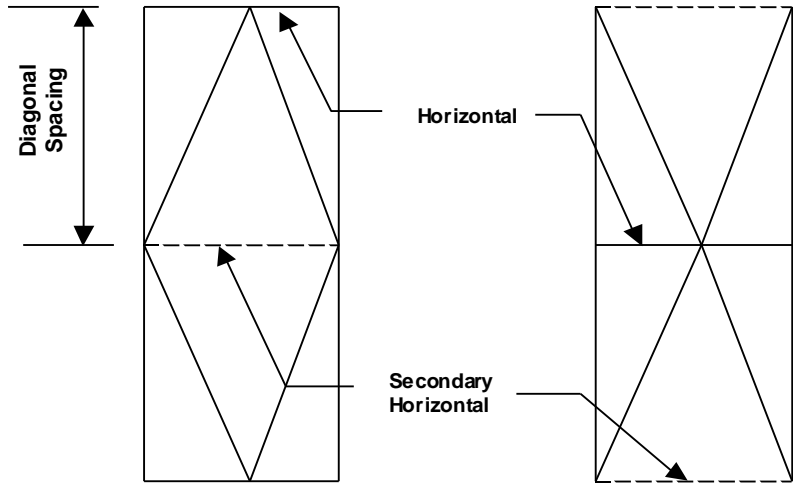

Diamond

Double K

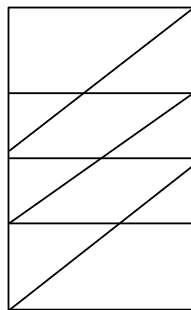

Z - Rohn 65

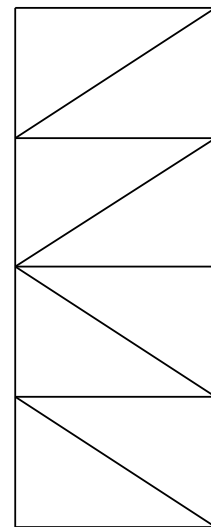
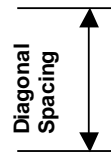

M - Bracing

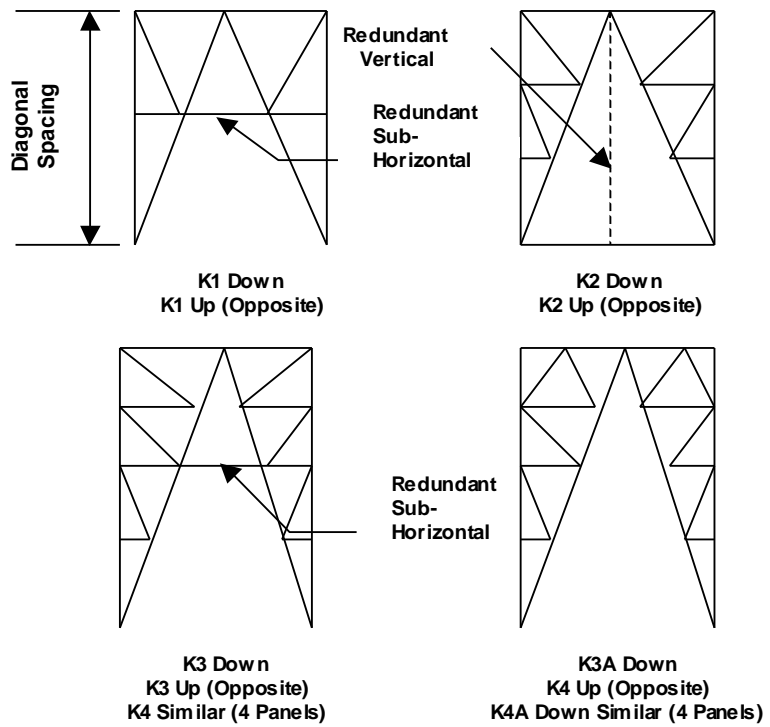
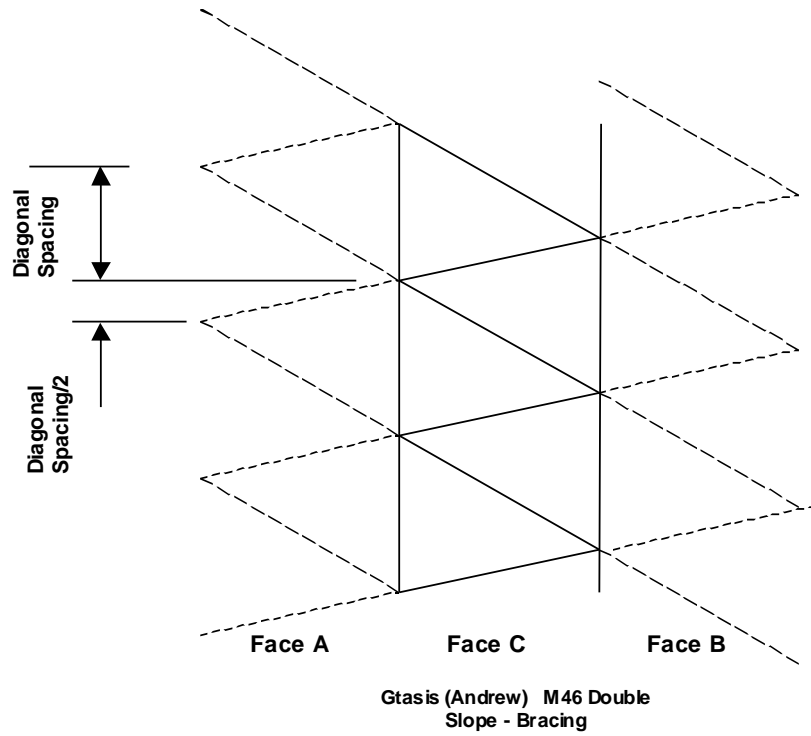

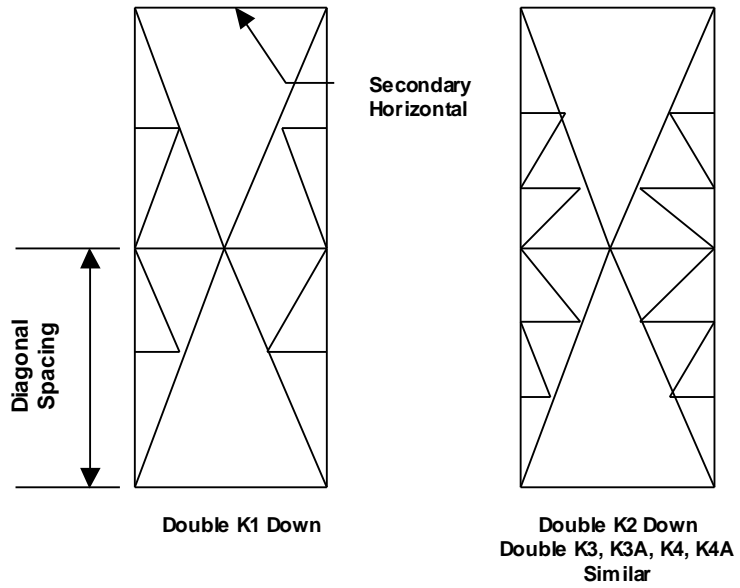
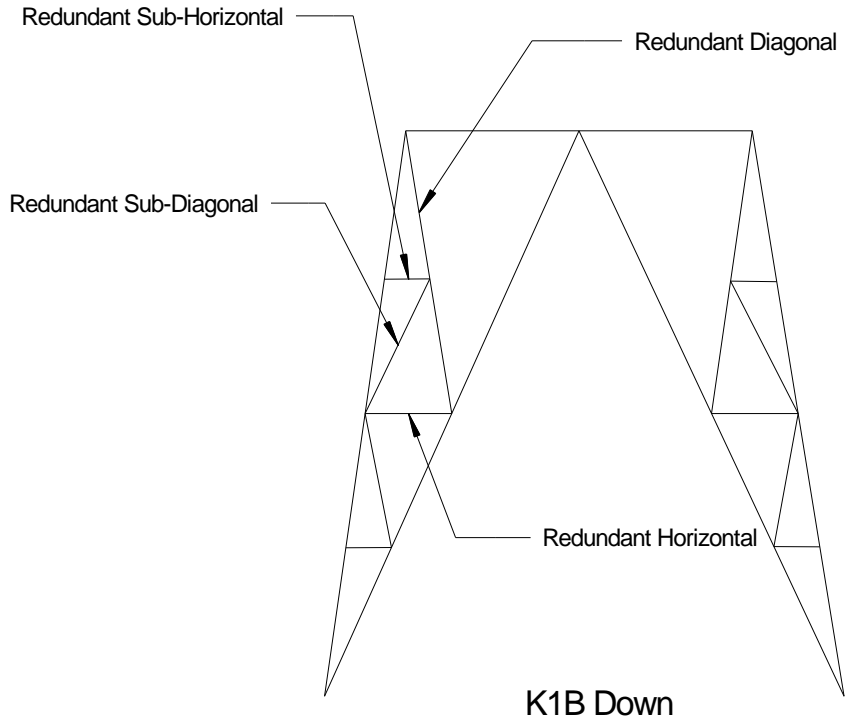

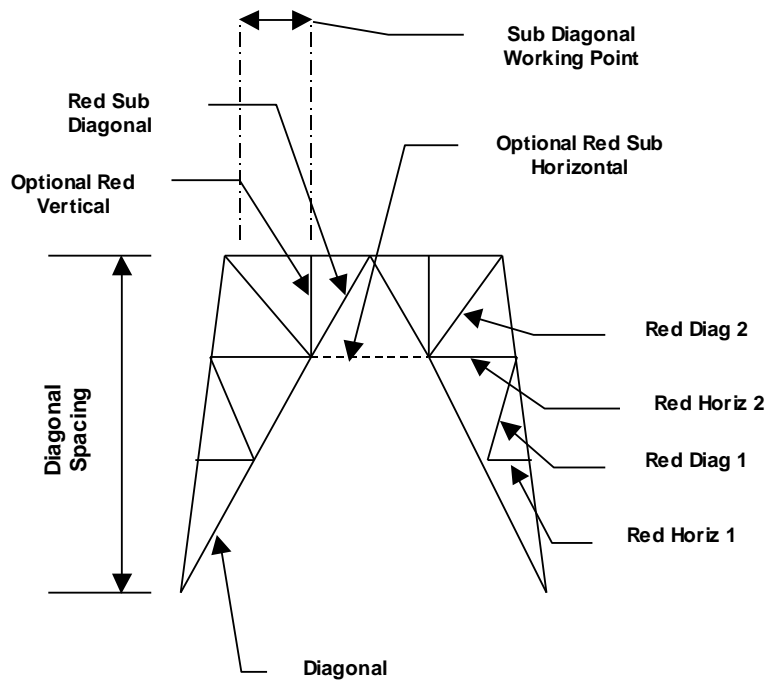

Cranked K Bracing

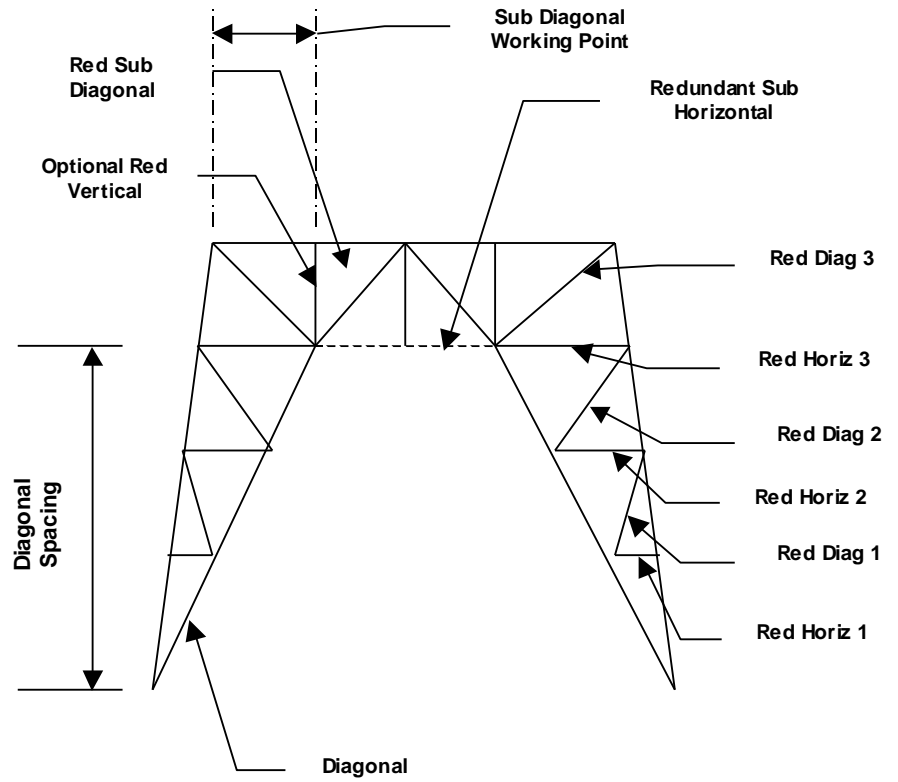

Cranked K2 Bracing

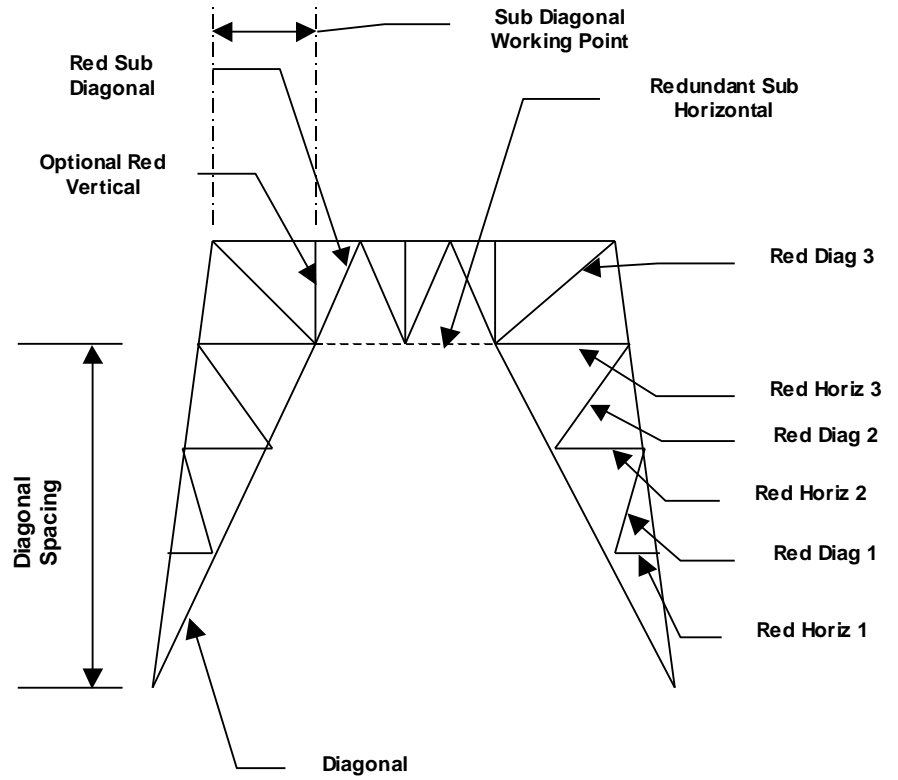

Portal Bracing

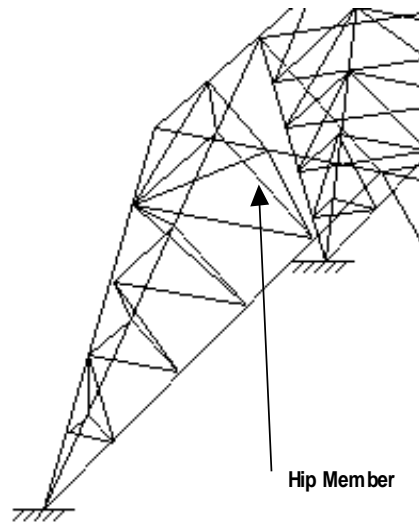

Hip Bracing

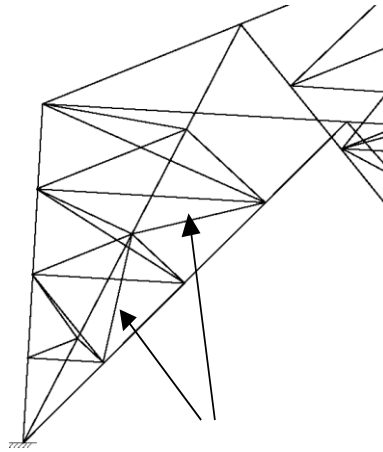

Hip Diagonal Member

Hip Bracing - diagonals

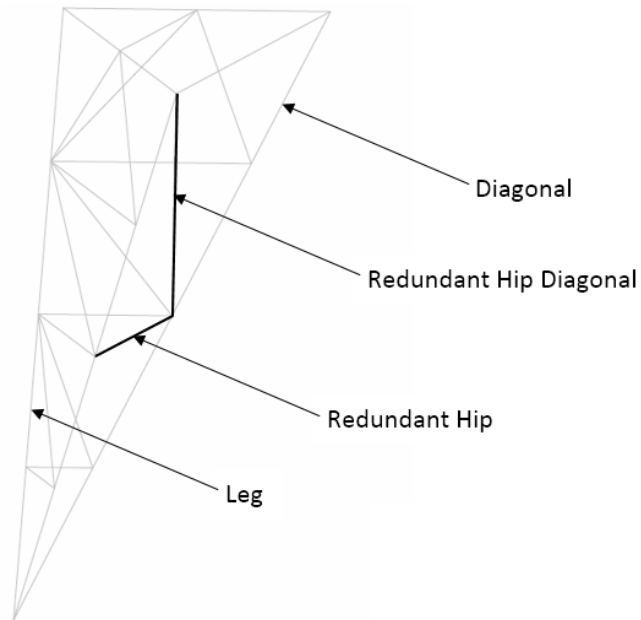

K3A M Down Bracing

K3A M Down Bracing is a special case of the K3A Down pattern, where the hip member braces the diagonals at mid-span only.

The Z-Brace and Z-Rohn 65 types are special forms of diagonal up bracing. The diagonal type, size and grade in these types will automatically be copied to the horizontal type, size and grade. Z-Rohn 65 also will have the diagonal information copied to the top and bottom girt information.

Face Bevel

This is a read-only column and is automatically calculated by the program using the top face width of each row and the distance between the sections.

Has K-Brace End Panels

Enter **Yes** if there are K-braced end panels in the section, otherwise **No**.

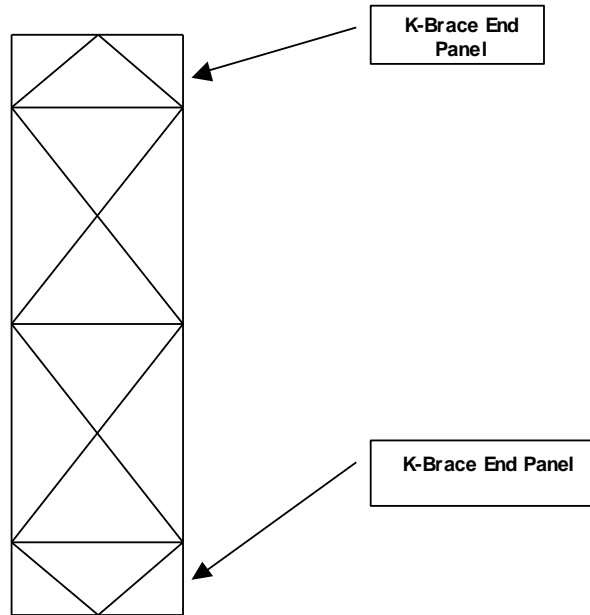

Has Horizontals

Horizontals can be of the following types:

- **Guy Pull-Off.** Specified in the Guy Data spreadsheet, these occur at points where guys or torque arms meet the tower.
- **Top or Bottom Girt.** These horizontals occur at the far ends of the tower section.
- **Mid Girt.** Some tower manufacturers break up their sections in sub-sections, placing a mid-girt at the end of each sub-section.
- **Horizontal.** The main horizontal members that are in the section everywhere except at the far ends.
- **Secondary Horizontal.** Used for step members and for auxiliary horizontals used reducing tower leg bracing distances (KL) when used with the Secondary Horizontal Braces Leg Option.

Horizontal types higher in the hierarchy will over ride horizontals that are lower in the hierarchy. For instance, a girt will always replace a horizontal, and a guy pull-off will override any other horizontal type.

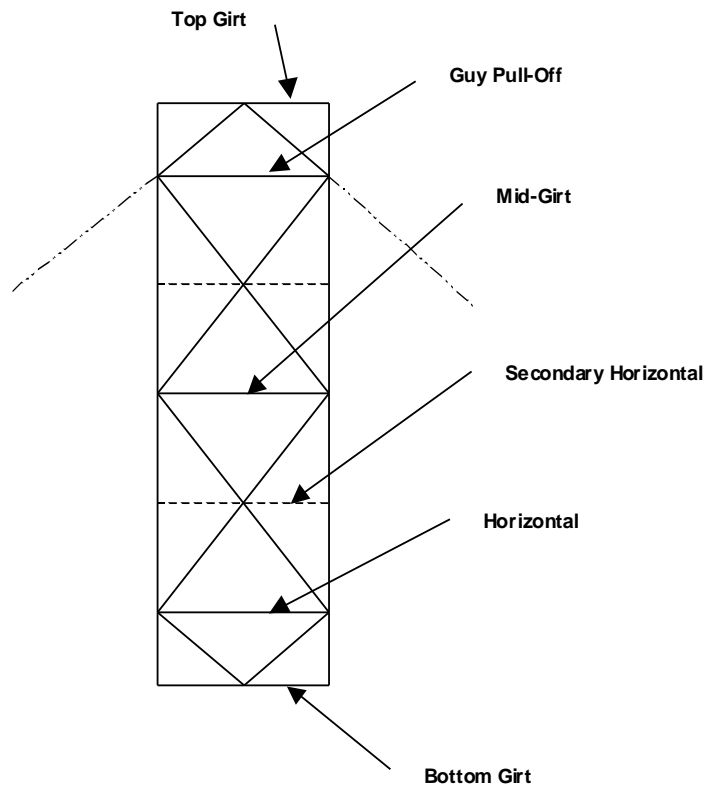

Enter the type of horizontals to be generated:

- **No.** Horizontals are not generated.
- **Yes.** Horizontals (horizontal size) are generated. Secondary horizontals will also be generated if the secondary horizontal size is stipulated for diamond. Double-K, X, CX and TX bracing types are shown by dashed lines in the bracing type figure. See Bracing Type.
- **Yes+Steps.** Steps (secondary horizontal size) are generated in the front face only from the leg to the diagonal member for all bracing types where a diagonal passes through the midpoint of the panel. Other horizontals are generated as for the **Yes** option.

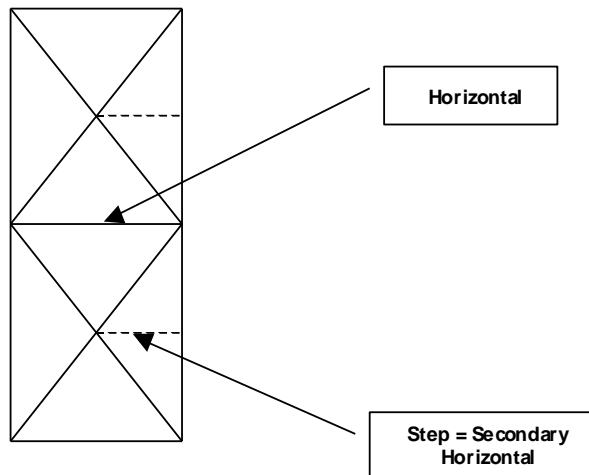

- Steps.** Steps (secondary horizontal size) are generated in the front face only from the leg to the diagonal member for all bracing types where a diagonal passes through the midpoint of the panel. Horizontals (horizontal size) are generated in the front face only.

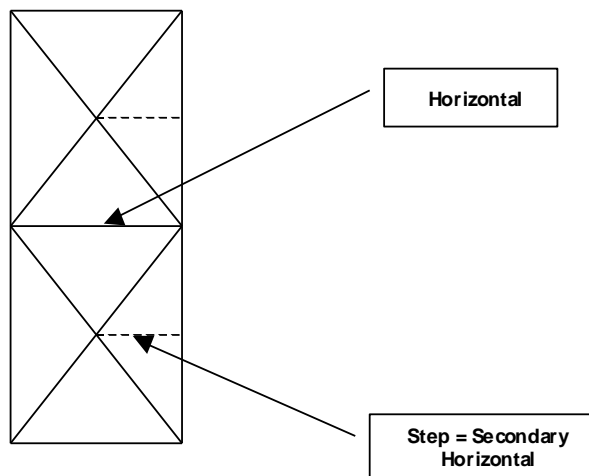

Leg Type

Select the steel shape type for the leg members. Choices are limited to those shapes that are installed with the application. Standard types are angles, solid rounds and pipe.

Leg Size

Select a size for the steel leg member from the choices found in the list box. You may add or restrict which shapes by using the Database Editor.

Leg Grade

Enter the grade for the leg steel. Common values are A36 or A572-50.

Diagonal Type

Select the steel shape type for the diagonal members. Choices are limited to those shapes that are installed with the application. Standard types are angles, double angles, channels, solid rounds and pipe.

Diagonal Size

Select a size for the steel diagonal member from the choices found in the list box. You may add or restrict which shapes by using the Database Editor.

A special type of framing is generated when the diagonal size is left blank. A Vierendeel frame will be created between the leg and horizontal members in the section.

Diagonal Grade

Enter the grade for the diagonal steel. Common values are A36 or A572-50.

Top Girt Offset

Enter the amount that the top girt will be offset.

Bottom Girt Offset

Enter the amount that the bottom girt will be offset.

Top Girt Type

Top and bottom girts occur only at the far ends of each section. They are offset from the ends by the amount of the **Girt Offset**. See Girt Offsets.

Select the steel shape type for the top and bottom girt members. Choices are limited to those shapes that are installed with the application. Standard types are angles, double angles, channels, solid rounds and pipe.

Top Girt Size

Select a size for the steel top girt member from the choices found in the list box. You may add or restrict which shapes by using the Database Editor. When there is no top girt members, just leave the field blank. An exception occurs at the very top of the tower where a girt is required. When the girt is left blank in this instance, a girt the same size as the diagonal will be inserted automatically.

Top Girt Grade

Enter the grade for the top girt. Common values are A36 or A572-50.

Bottom Girt Type

Top and bottom girts occur only at the far ends of each section. They are offset from the ends by the amount of the **Girt Offset**. See Girt Offsets.

Select the steel shape type for the top and bottom girt members. Choices are limited to those shapes that are installed with the application. Standard types are angles, double angles, channels, solid rounds and pipe.

Bottom Girt Size

Select a size for the steel bottom girt member from the choices found in the list box. You may add or restrict which shapes by using the Database Editor. When there is no bottom girt members, just leave the field blank.

Bottom Girt Grade

Enter the grade for the bottom girt. Common values are A36 or A572-50.

Number of Mid Girts

Mid girts occur evenly spaced between the top and bottom girts. When the number is set to zero, it is assumed that there are no mid girts.

Mid Girt Type

Select the steel shape type for the mid girt members. Choices are limited to those shapes that are installed with the application. Standard types are angles, double angles, channels, solid rounds and pipe.

Mid Girt Size

Select a size for the steel mid girt member from the choices found in the list box. You may add or restrict which shapes by using the Database Editor. When there are no mid girt members, just leave the field blank.

Mid Girt Grade

Enter the grade for the mid girts. Common values are A36 or A572-50.

Horizontal Type

Select the steel shape type for the horizontal members. Choices are limited to those shapes that are installed with the application. Standard types are angles, double angles, channels, solid rounds and pipe.

Horizontal Size

Select a size for the steel horizontal member from the choices found in the list box. You may add or restrict which shapes by using the Database Editor. When there are no horizontal members, just leave the field blank.

Horizontal Grade

Enter the grade for the horizontals. Common values are A36 or A572-50.

Secondary Horizontal Type

Select the steel shape type for the secondary horizontal members. Choices are limited to those shapes that are installed with the application. Standard types are angles, double angles, channels, solid rounds and pipe.

Secondary Horizontal Size

Select a size for the steel secondary horizontal member from the choices found in the list box. You may add or restrict which shapes by using the Database Editor. When there are no secondary members, just leave the field blank. Secondary horizontals are used in Diamond, Double K, X, CX and TX bracing types. These members are assumed not to be triangulated and therefore do not have sufficient strength to brace leg members.

Secondary Horizontal Grade

Enter the grade for the secondary horizontals. Common values are A36 or A572-50.

Inner Bracing Type

Select the steel shape type for the inner bracing members. Choices are limited to those shapes that are installed with the application. Standard types are angles, double angles, channels, solid rounds and pipe.

Inner Bracing Size

Select a size for the steel inner bracing member from the choices found in the list box. You may add or restrict which shapes by using the Database Editor. When there is no inner bracing members, just leave the field blank.

Inner Bracing Grade

Enter the grade for the inner bracing steel. Inner bracing consists of supporting members in the horizontal plane. Common values are A36 or A572-50.

Redundant Bracing Type

Select the steel shape type for the redundant bracing members. Choices are limited to those shapes that are installed with the application. Standard types are angles, double angles, channels, solid rounds and pipe. Redundant members are designed for the force in the brace or 1.5% of the axial compressive load in the member that the redundant braces.

Redundant Bracing Grade

Enter the grade for the redundant bracing steel. Redundant bracing consists of supporting members in K1, K2, K3, K4, K2A, K3A, K4A, Cranked K and Portal bracing types. Common values are A36 or A572-50.

Redundant Horizontal Size (1-4)

Select a size for the steel redundant horizontal bracing members from the choices found in the list box. You may add or restrict which shapes by using the Database Editor. Redundant bracing consists of supporting members in K1, K2, K3, K4, K2A, K3A, K4A, Cranked K and Portal bracing types.

In the K1 bracing type, the redundant horizontal may be left blank, leaving only the diagonal as the brace. This is a common situation in Andrew self-supporting towers. The braces are numbered 1 through 4 beginning at the bottom of the panel.

Redundant Diagonal Type

Select the steel shape type for the redundant diagonal bracing members. Choices are limited to those shapes that are installed with the application. Standard types are angles, double angles, channels, solid rounds and pipe. Redundant members are designed for the force in the brace or 1.5% of the axial compressive load in the member that the redundant braces.

Redundant Diagonal Size (1-4)

Select a size for the steel redundant diagonal bracing members from the choices found in the list box. You may add or restrict which shapes by using the Database Editor. Redundant bracing consists of supporting members in K1, K2, K3, K4, K2A, K3A, K4A, Cranked K and Portal bracing types. The braces are numbered 1 through 4 beginning at the bottom of the panel.

Redundant Sub Diagonal Type

Select the steel shape type for the redundant sub diagonal bracing members. This type is only used in Cranked K or Portal bracing schemes. Choices are limited to those shapes that are installed with the application. Standard types are angles, double angles, channels, solid rounds and pipe.

**Redundant Sub
Diagonal Size**

Select a size for the steel redundant sub diagonal bracing members from the choices found in the list box. This type is only used in Cranked K or Portal bracing schemes. You may add or restrict which shapes by using the Database Editor.

**Redundant Sub
Diagonal Working Point**

This is only used in Cranked K or Portal bracing schemes. Enter the fraction of the face width where the main diagonal and sub-diagonal meet.

**Redundant Sub-
Horizontal Type**

Select the steel shape type for the redundant sub-horizontal bracing members. Choices are limited to those shapes that are installed with the application. Standard types are angles, double angles, channels, solid rounds and pipe. Redundant members are designed for the force in the brace or 1.5% of the axial compressive load in the member that the redundant braces.

**Redundant Sub-
Horizontal Size**

Select a size for the steel redundant sub-horizontal bracing members from the choices found in the list box. You may add or restrict which shapes by using the Database Editor. Redundant bracing consists of supporting members in K1, K2, K3, K4, K2A K3A, K4A, Cranked K and Portal bracing types.

**Redundant Vertical
Type**

Select the steel shape type for the redundant vertical bracing members. Choices are limited to those shapes that are installed with the application. Standard types are angles, double angles, channels, solid rounds and pipe. Redundant members are designed for the force in the brace or 1.5% of the axial compressive load in the member that the redundant braces.

Redundant Vertical Size

Select a size for the steel redundant vertical bracing members from the choices found in the list box. You may add or restrict which shapes by using the Database Editor. Redundant vertical bracing consists of supporting members in K-Down, Double-K, K1, K2, K3, K4, K2A K3A, K4A, Cranked K and Portal bracing types. A redundant vertical cannot exist at the same time a redundant sub-horizontal exists.

**Redundant Hip Size (1-
4)**

Select a size for the steel redundant hip bracing members from the choices found in the list box. Hip bracing is horizontal bracing that runs between the redundant horizontals on each adjacent face of the tower. You may add or restrict which shapes by using the Database Editor. Redundant bracing consists of supporting members in K1, K2, K3, K3A, K4, K4A, Cranked K and Portal bracing types. When the hip size is left blank, the main diagonal in the panel will be unbraced for the entire length about its y-axis. The braces are numbered 1 through 4 beginning at the bottom of the panel.

**Redundant Hip
Diagonal Size**

Select a size for the steel redundant hip diagonal bracing members from the choices found in the list box. Hip diagonal bracing is lacing that runs between the redundant hips and the main diagonals on the adjacent faces of the tower. You may add or restrict which shapes by using the Database Editor. Redundant bracing consists of supporting members in K2, K3, K4, K2A K3A, K4A, Cranked K and Portal bracing types.

Advanced Data

Summary

Advanced data allows the user to specify additional information about each section beyond the scope of the Tower Geometry entry tab.

Section Height Above Base

This is a read-only field and is generated at the time that you created your section information. See Geometry Data.

Area Adjustment Factors

Adjustment Factor Face Af

tnxTower automatically calculates the area of flats from the member sizes. However, this area may need to be adjusted for items such as gusset plates, lift lugs, ladders, etc. This factor is a multiplier times the Af of the structural members, not including feed lines treated as Af. It is assumed the same for all faces.

Adjustment Factor Face Ar

tnxTower automatically calculates the area of rounds from the member sizes. However, this area may need to be adjusted. This factor is a multiplier times the Ar of the structural members, not including feed lines treated as Ar. It is assumed the same for all faces.

Irregular Projected Area Adjustment Factors (Ratios):

Round IPA on Poles

Available under TIA-222-G and TIA-222-H Standards only. These settings allow to include in the model areas of miscellaneous irregular parts (e.g., step bolts) that are not accounted for in the Geometry input, and which are directly attached to the structural members of the tower.

Flat IPA on Poles

Round IPA on Legs

Flat IPA on Legs

Flat IPA on Horizontals

Unlike the input for the **Area Adjustment Factors** (see above), the **Irregular Projected Area** factors specify areas that are subject to automatic reduction in accordance with TIA-222-G (2.6.9.1.1, Table 2-7) and TIA-222-H (2.6.11.1.1, Table 2-8a). In addition, the IPA has an impact on the value of the Effective Projected Area of round components within each tower section (including monopole sections) for which it is entered. The program will automatically adjust the Cf values for monopoles and the Rr values for lattice round members.

Round IPA on Horizontals

Flat IPA on Diagonals

Round IPA on Diagonals

The input is provided separately for IPAs of flat and round attachments. Those areas are then added, if applicable, to the areas of flat and/or round appurtenances with appropriate Ca coefficients.

Any component areas entered via the **Area Adjustment Factors** should not be duplicated here.

Weight Adjustment Factor

Weight Multiplier

This factor will be multiplied times the self-weight of the structural members to determine the section weight. This factor is supplied to take into account the weight of gusset plates not entered as gusset area, ladders, galvanizing, etc.

Pressure Adjustment Factor

Wind Pressure Multiplier

Any nonnegative value (including zero) may be specified. The Multiplier modifies pressures applied to all tower components, for all wind directions, within a section(s) for which it is defined. For the User Forces and Antenna Pole input categories, the multiplier modifies the EPA-derived forces only (i.e., “CaAc Shear” and “Pole CaAa”, respectively).

K Factors

K factors are the effective column buckling length factor as defined in the AISC standard. Users should also refer to ASCE 10-97 for determining the appropriate K factors for single angle compression members. The ASCE formulae take into account normal framing eccentricities.

Auto-Calc Single Angle K-Factors

When checked, the program will automatically calculate an appropriate K-factor for single angle members as well as the x-axis of double angle members within the section. See the Technical Appendix for more information.

Auto-Calc Solid Round K-Factors

When checked, the program will automatically calculate an appropriate K-factor for solid round members within the section. See the Technical Appendix for more information.

K Legs

The effective length factor, K, for the leg can be set by the user. This factor is multiplied times each panel length to determine KL/r , which in turn determines the allowable axial stress on the leg. For example, if a 20 foot section has 4 panels and $K=1.2$, then L would be equal to 5 feet and $KL=6$ feet (1.2×5). This factor is ignored for monopoles.

K Truss-Legs

Three entries allow you to control the K factor for the individual leg panel member (usually a solid round leg member) within the truss-leg, as well as any X-braced diagonal members and Z-braced diagonal members. There is a separate set of three entries for tower legs as well as for tower inner members when truss-legs are used for horizontal or diagonal members.

K X-Brace Diagonals

The effective length factors, K, for the diagonal bracing can be set by the user. This factor is multiplied times the unbraced length to determine KL/r that in turn determines the allowable axial stress on the diagonals. X-brace diagonals are assumed to be connected to one another. They are assumed to have a bolt or welded stitch plate where the x-bracing crosses at the mid-point. L_u is therefore $\frac{1}{2}$ the total diagonal distance. CX and TX bracing is assumed not to be interconnected and L_u is there the total diagonal distance. Therefore, KL for X-brace

diagonals with a $K=1$ would be $\frac{1}{2}$ the diagonal distance and KL for TX bracing with $K=1$ would be the full diagonal distance.

K K-Brace Diagonals

The effective length factor, K_x and K_y , for the K-brace diagonals (K-brace up, down, TK-brace up, down, K-brace left, right, double-K and diamond) can be set by the user. This factor is multiplied times the diagonal length to determine KL/r , which in turn determines the allowable axial stress on the diagonal. When using K1, K2, K3, K3A, K4 and K4A bracing types, the program automatically assumes the unbraced length as being the distance between the redundant braces.

K-brace left and right, when there is no horizontal specified, is known as staggered bracing. The K factor for this situation should be 2 since the diagonal is not capable of bracing the leg. When you forget to enter a K factor greater than 1 in this situation, the program will automatically double the K factor that is input.

K Single Diagonals

The effective length factor, K_x and K_y , for the single brace diagonals (diagonal up, down) can be set by the user. This factor is multiplied times the diagonal length to determine KL/r , which in turn determines the allowable axial stress on the diagonal.

K Girts

The effective length factor, K_x and K_y , for the girts and mid-girts can be set by the user. This factor is multiplied times the horizontal length to determine KL/r , which in turn determines the allowable axial stress on the member.

For horizontal members that support K-braces, it is assumed that the out-of-plane unbraced length is the leg-to-leg distance if inner bracing is not provided. When inner bracing is provided, the unbraced length is the one-half the leg-to-leg length.

K Horizontals, Secondary Horizontals

The effective length factor, K_x and K_y , for the horizontals (horizontals and secondary horizontals, guy pull-offs) can be set by the user. This factor is multiplied times the horizontal length to determine KL/r , which in turn determines the allowable axial stress on the member.

For horizontal members that support K-braces, it is assumed that the out-of-plane unbraced length is the leg-to-leg distance if inner bracing is not provided. When inner bracing is provided, the unbraced length is the one-half the leg-to-leg length.

K Inner Bracing

The effective length factor, K_x and K_y , for inner bracing (bracing in the horizontal plane that supports K-bracing in the out-of-plane direction) can be set by the user. This factor is multiplied times the length to determine KL/r , which in turn determines the allowable axial stress on the member.

K Redundant Horizontals

The effective length factor, K , for redundant horizontals, can be set by the user. This factor is multiplied times the length to determine KL/r , which in turn determines the allowable axial stress on the member.

K Redundant Diagonals

The effective length factor, K , for redundant diagonals, can be set by the user. This factor is multiplied times the length to determine KL/r , which in turn determines the allowable axial stress on the member.

K Redundant Sub Diagonals

The effective length factor, K , for redundant sub diagonals, can be set by the user. This factor is multiplied times the length to determine KL/r , which in turn determines the allowable axial stress on the member.

K Redundant Hips

The effective length factor, K , for redundant hips, can be set by the user. This factor is multiplied times the length to determine KL/r , which in turn determines the allowable axial stress on the member.

Connection Data

Double Angle Stitch Bolt At Mid-Point

When checked, the program will automatically calculate Kl/r of double angles assuming a bolt at the mid-point of each span using the equation specified in EIA 222-F section 3.1.3 and setting the "a" value to this distance. When left unchecked, the actual distance may be specified. A separate box for diagonal and horizontal members is provided.

Double Angle Stitch Bolt Spacing

Specify the distance between bolts that ties the two angles together. This also applies to quad angles if they are used. Kl/r of double angles is then calculated using the equation specified in EIA 222-F section 3.1.3 and setting the "a" value to this spacing. A separate entry for diagonal and horizontal members is provided.

Tension Area Net Width Deduct

Bolted towers that have members that are in tension must use the net area to calculate the tension stress. Enter the net width of the member that should be subtracted to account for bolt holes. For leg angle members, the value is assumed to be the deduction for **each** connected leg of the angle. For non-leg angle members, the deduction is for **one** connected leg of the angle. When the value is set to 0, the value will be calculated automatically from the bolt hole size + 1/16".

Tension U-Factor

The AISC specification requires that the net area calculation include a U-factor. See Chapter B3 of the AISC 9th Edition.

Gusset Plate Area

Enter the total area of flat gusset plate area in one face of the section. When each face has a different plate area, then use the face that has the greatest gusset area. The gusset plate area will not be factored by the Af adjustment factor or the weight adjustment multiplier. The program will use this value to calculate the value of Af for the gusset plates. This area will be treated as a structural element with regards to wind area.

Gusset Plate Thickness

Enter the thickness of the gusset plates used in the section. The program will use this value to calculate the gusset weight as well as the edge ice thickness on the plate and bolt bearing stresses.

Leg Connection Type

Legs can be connected with bolts in tension (flange plate connection) or in double shear (sleeve DS type connection) or in single shear (sleeve SS type connection).

Flange connections are commonly found in towers that have pipe or solid round leg members, although some tower manufacturers, such as PiRod, use sleeve type connections for their solid round leg towers. Sleeve connections can take both axial compression and tension whereas flange connections only withstand tension forces.

Bolt Grade

Each section of the tower may have a different bolt grade. Choose from the list of available grades shown in the drop down list.

Bolt Size

Enter the nominal diameter of the bolt that is used.

Number of Bolts

Enter the number of bolts used in the connection at each end of the member. When the member is a leg, then enter the number of bolts **per leg**. Should the connection is welded, enter zero. In design mode, the number entered is considered to be the minimum number of bolts to be used. The number of bolts per leg in a sleeve type is the total number of bolts on both sides of the splice. Therefore one-half of the bolts are transmitting the force to the leg. The exception is the solid round (PiRod) type sleeve, where all of the bolts will transmit the force.

Out-Of-Plane Restraint

When selected, the program will assume that the connection provides partial restraint of the member in the out-of-plane direction. This option is not available or cannot be selected if the number of bolts entered is one (see TIA-222-G, H, section 4.5.2).

Bolt Edge Distance

The edge distance is taken from the edge of the member to the center of the bolt hole. When the AutoCalc setting is used, the edge distance is assumed to be 1.5 times the nominal bolt diameter.

Gage Distance

The gage distance is taken from the heel of the angle section to the center of the bolt hole. When the AutoCalc setting is used, the gage distance is assumed to be the AISC standard workable gage value.

Connection Length Reduction Factor

TIA-222-H only: The connection length reduction factor R_b is assumed to be 1.0.

Diagonal Offsets

Offsets allow the user to model situations where the working points of the diagonals fall outside of the working points of the legs as illustrated below. Offsets usually occur because of interference with various framing members or when gusset plates are used. The default offset is zero, which assumes that legs, horizontals and diagonals intersect at a common working point. When offsets are introduced, the length of the diagonal is assumed to be reduced by the amount of the offsets. It is assumed that offsets are **always** to the inside of the tower, in other words, diagonals never extend over the leg to the outside of the tower. Offsets are assumed the same for all diagonals in the section.

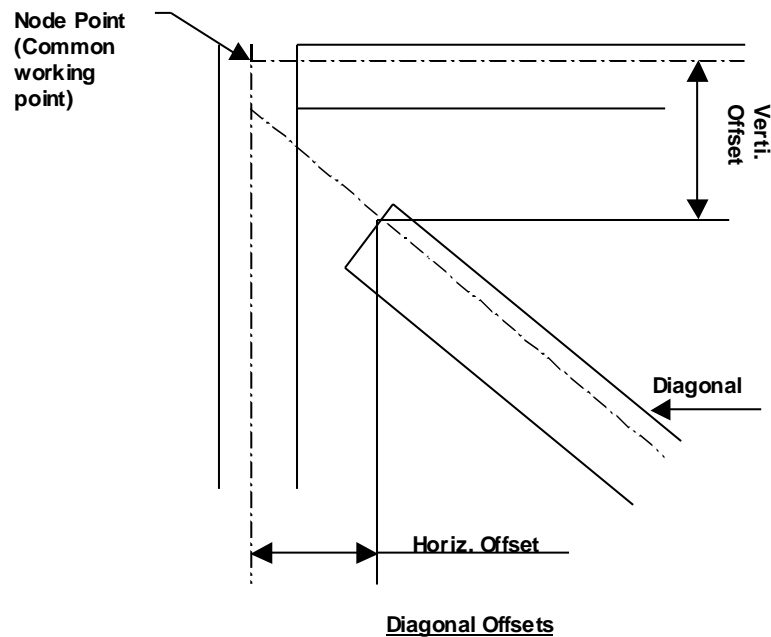

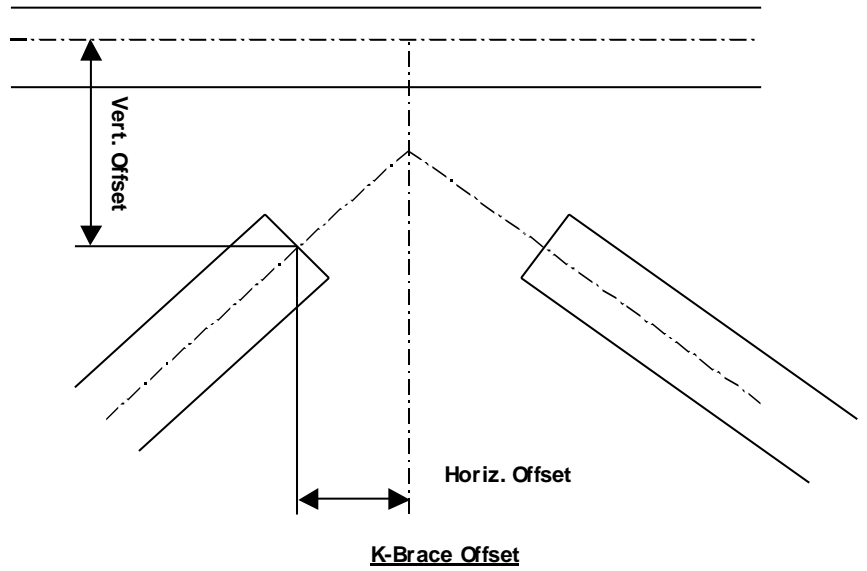

Diagonal Vertical and Horizontal Offset Top

Enter the amount of offset at the top of the diagonal members.

Diagonal Vertical and Horizontal Offset Bottom

Enter the amount of offset at the bottom of the diagonal members.

K-Brace Vertical and Horizontal Offset Top

Enter the amount of offset at the top of the diagonal members of a K-brace.

K-Brace Vertical and Horizontal Offset Bottom

Enter the amount of offset at the bottom of the diagonal members of a K-brace.

Guy Data

	Height Above Base (ft)	Mount Type	Guy Grade	Auto Correct Height	All Guys Identical	Guy A					
						Size	% Initial Tension	Anchor Azimuth Adjustment (deg)	Anchor Radius (ft)	Anchor Elev (ft)	End Efficiency
1	759'11"	Corner	BS	<input checked="" type="checkbox"/>	<input type="checkbox"/>	1	10	0.0000	570'	0'	9
2	593'-21.032"	Corner	BS	<input checked="" type="checkbox"/>	<input type="checkbox"/>	1 1/8	10	0.0000	570'	0'	9
3	434'11"	Corner	BS	<input checked="" type="checkbox"/>	<input type="checkbox"/>	1 1/8	10	0.0000	325'	0'	9
4	278'-11.032"	Corner	BS	<input checked="" type="checkbox"/>	<input type="checkbox"/>	1 5/16	10	0.0000	325'	0'	9
5	134'11"	Corner	BS	<input checked="" type="checkbox"/>	<input type="checkbox"/>	7/8	10	0.0000	325'	0'	9
6				<input type="checkbox"/>	<input type="checkbox"/>						
7				<input type="checkbox"/>	<input type="checkbox"/>						
8				<input type="checkbox"/>	<input type="checkbox"/>						
9				<input type="checkbox"/>	<input type="checkbox"/>						
10				<input type="checkbox"/>	<input type="checkbox"/>						
11				<input type="checkbox"/>	<input type="checkbox"/>						
12				<input type="checkbox"/>	<input type="checkbox"/>						
13				<input type="checkbox"/>	<input type="checkbox"/>						
14				<input type="checkbox"/>	<input type="checkbox"/>						
15				<input type="checkbox"/>	<input type="checkbox"/>						
16				<input type="checkbox"/>	<input type="checkbox"/>						
17				<input type="checkbox"/>	<input type="checkbox"/>						
18				<input type="checkbox"/>	<input type="checkbox"/>						
19				<input type="checkbox"/>	<input type="checkbox"/>						
20				<input type="checkbox"/>	<input type="checkbox"/>						
21				<input type="checkbox"/>	<input type="checkbox"/>						
22				<input type="checkbox"/>	<input type="checkbox"/>						
23				<input type="checkbox"/>	<input type="checkbox"/>						
24				<input type="checkbox"/>	<input type="checkbox"/>						
25				<input type="checkbox"/>	<input type="checkbox"/>						
26				<input type="checkbox"/>	<input type="checkbox"/>						
27				<input type="checkbox"/>	<input type="checkbox"/>						
28				<input type="checkbox"/>	<input type="checkbox"/>						
29				<input type="checkbox"/>	<input type="checkbox"/>						
30				<input type="checkbox"/>	<input type="checkbox"/>						

Guy Data Entry

To delete any row, you may click on the row number and hit the delete key. Inserting a row below the current is done in the same manner except that you key the insert key. When a row is inserted, the current row is copied down to the newly inserted row. Deleting or inserting multiple rows may be accomplished by clicking and dragging the mouse up or down, or by using the shift or ctrl keys in combination with the left mouse button. Copying, cutting and pasting may be accomplished by selecting the row and then using Ctrl+C (to copy), Ctrl+X (to cut) and Ctrl+V (to paste).

Height Above Base

Enter the height above the base (not to be confused with the elevation) where the guy is to be mounted. When the height you indicate is within 2" of a location where a diagonal occurs, then the modeler will adjust the height to the nearest diagonal location. This adjustment is performed so that extremely small elements are not generated and so that the guy forces can be adequately distributed into the tower. This adjustment only occurs when the model is regenerated after you click **OK**. Note that if you specify a location more than 2" from a diagonal location, then the guy will be positioned exactly at the point specified. Diagonal legs of torque arms are always adjusted in this manner.

Mount Type

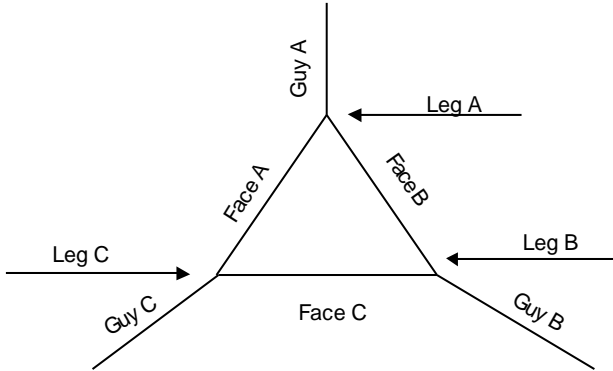

Corner Mounted

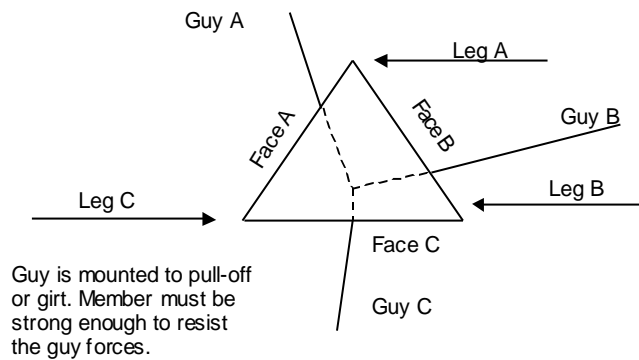

Strap Mounted

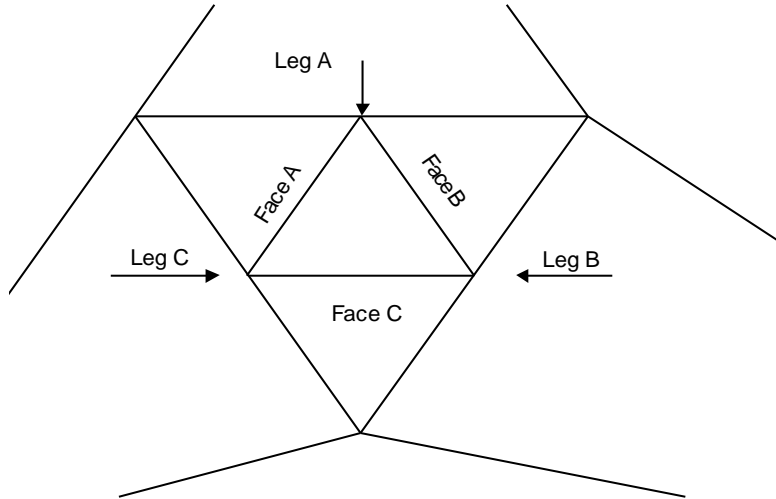

Torque-Arm (Starmount) Mounted

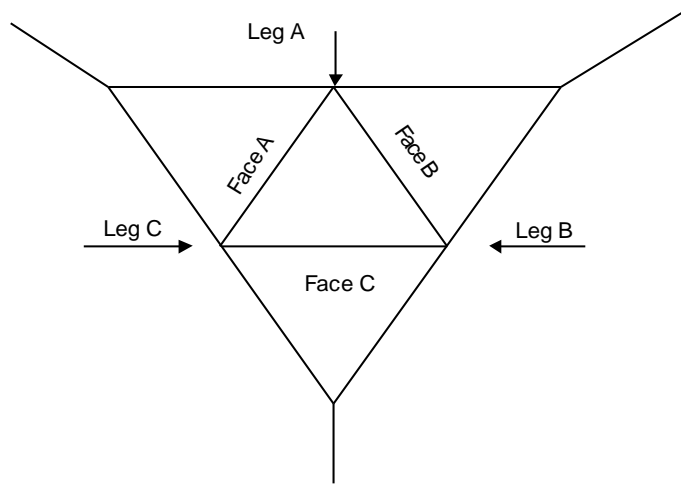

Torque-Arm Corner Mounted

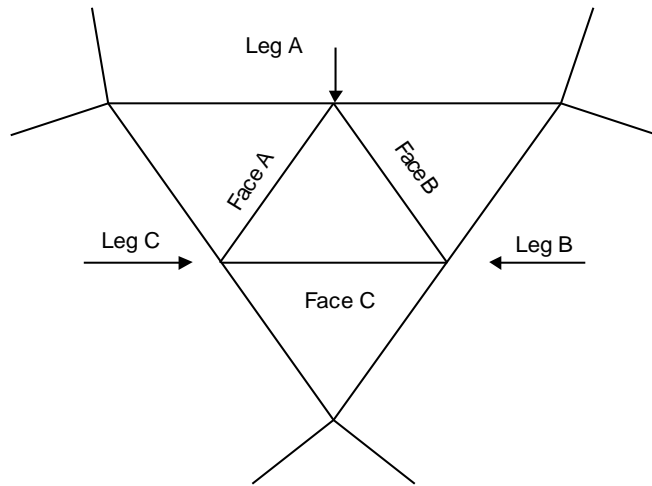

Torque-Arm Corner Flare Mounted

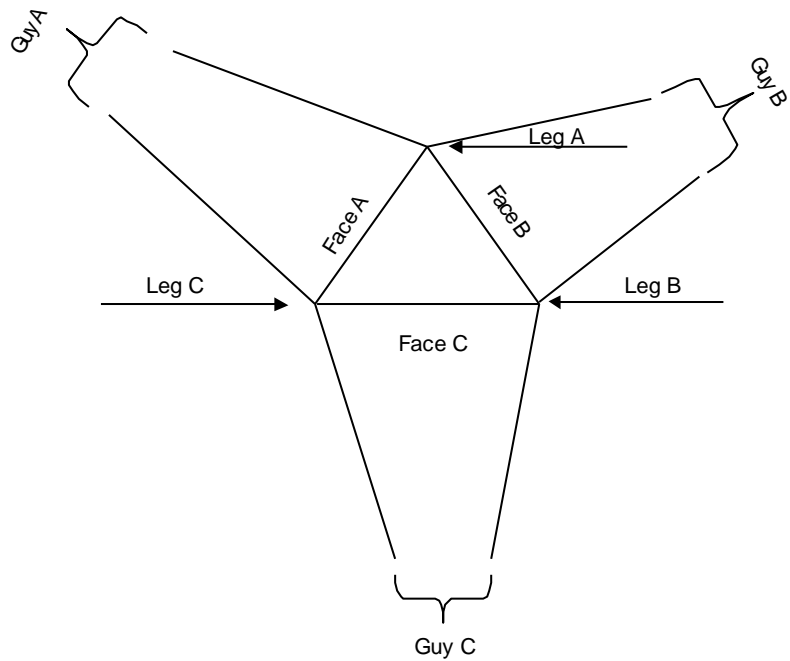

Face Mounted

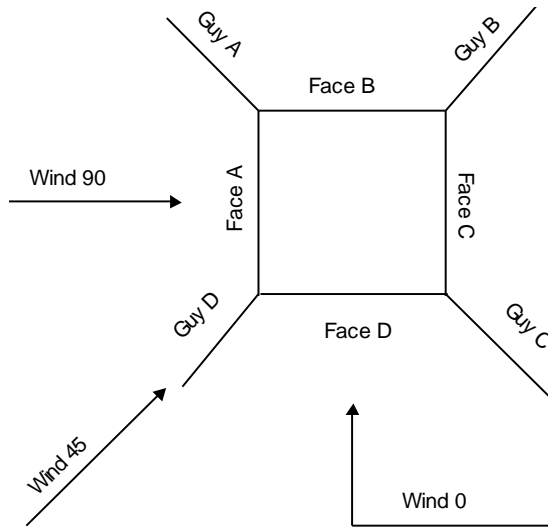

Square Corner Mounted Guyed Tower

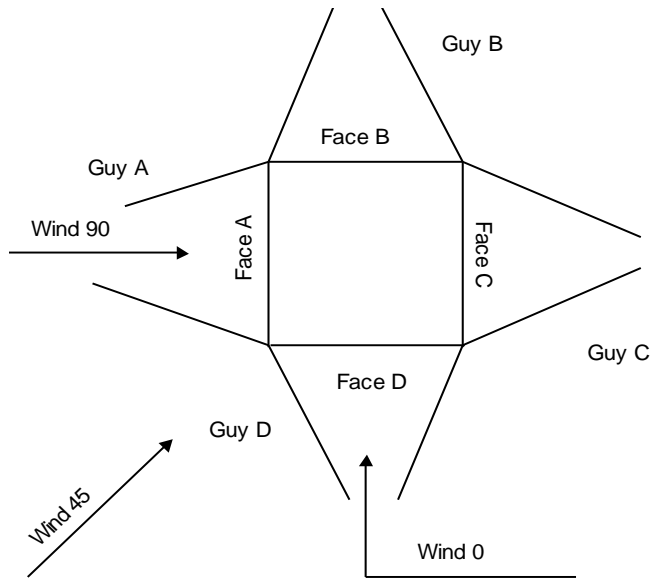

Square Face Mounted Guyed Tower

Guy Grade

Choose the guy type, EHS, BS or UHS. Choices are limited to those shapes that are installed with the application.

Auto Correct Height

When checked, the guy height will automatically be changed (after the model is regenerated) to correspond to a location where a diagonal intersects a leg member. When unchecked, the guy is positioned at the height entered, unless the guy is within 6 inches of a diagonal-leg intersection, in which case it will be adjusted to the intersection point. When a torque arm is used, then the bottom legs of the torque arm are always auto corrected.

All Guys Identical

When checked, all data entered for Guy A will be replicated automatically to all other guys in that spreadsheet row.

Guy Size

Select a size for the steel guys from the choices found in the list box. You may add or restrict which sizes by using the Database Editor. A guy may be eliminated by leaving the size blank.

Per Cent Initial Tension

Enter the initial tension for each of the three guys as a percentage of the breaking strength of the guy. This number is usually 10% but may vary when different drop elevations are used.

Anchor Azimuth Adjustment

Normally, the guys are placed at a 120-degree angle of separation from one another. You can adjust the placement of the degree by specifying an adjustment angle from these positions. Enter a number, between -60 and +60 degrees, specified in a clockwise direction, to adjust the position of the guy. For corner and torque-corner mounted guys, the angle is measured about the guy attachment point. All other mounts assume that angle is measured about the centroid of the tower.

Anchor Radius

Enter the radius from the centroid of the tower to each of the three guy anchor points.

Anchor Elevation

Enter the elevation for each of the guy anchor points. When the anchor is below the elevation for the base of the tower, you may enter a negative (-) elevation, if applicable.

End Fitting Efficiency

The breaking load of a guy wire may be achievable when the end fitting or take-up device on the guy has a lower rated breaking strength than for the guy wire itself. Enter a %, between 75 and 100, which accounts for any reduction in breaking load attributable to the end fittings of the guy wire.

Auto-Calc Solid Round K-Factors

When checked, the program will automatically calculate an appropriate K-factor for solid round members within the section. See the Technical Appendix for more information.

Torque Arm Style

There are four styles of torque-arms as shown below. The modeler will automatically attempt to position the torque arm so that it connects to a diagonal-leg connection point with an angle of approximately 30 degrees. When the modeler does not find a diagonal location, then it will adjust the angle until it does find an appropriate diagonal location.

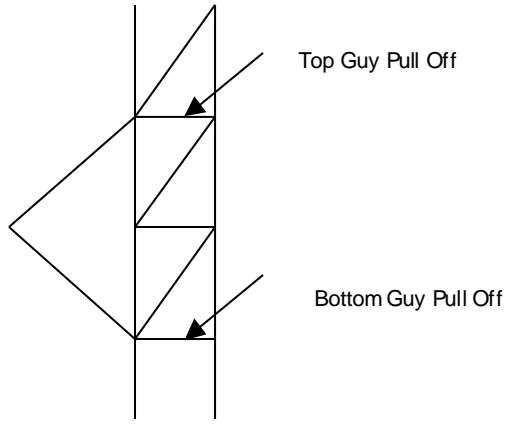

Wing Style

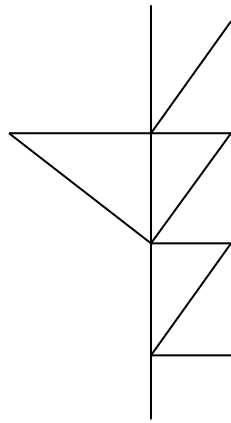

Bat Ear Style

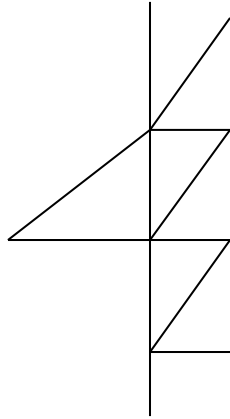

Dog-Ear Style

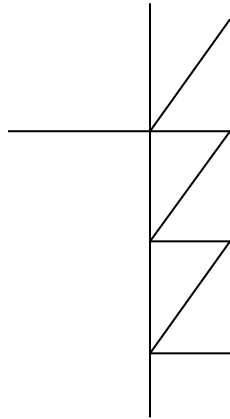

Channel (Cantilever) Style

Torque Arm Spread

Enter the face width of the torque arm. This is defined as the "tip-to-tip" dimension of the torque arm.

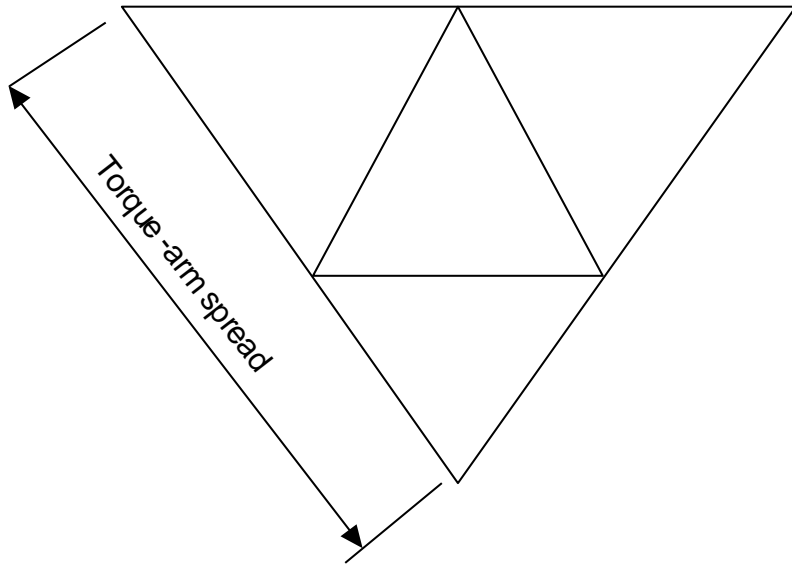

Torque Arm Leg Angle

Enter the approximate angle that the torque arm support leg makes with the horizontal plane. The modeler will update the field when the tower is regenerated. This field does not apply to channel type torque arms.

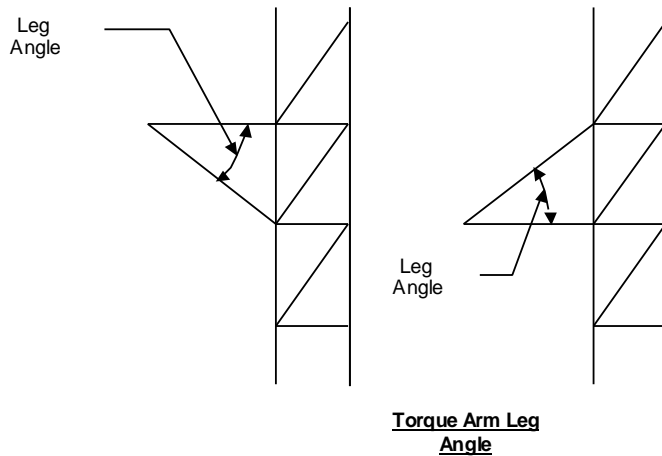

Torque Arm Type

Select the steel shape type for the torque arm members. Choices are limited to those shapes that are installed with the application. Standard types are angles, double angles, channels, solid rounds and pipe.

Torque Arm Size

Select a size for the steel torque arm member from the choices found in the list box. You may add or restrict which shapes by using the Database Editor.

Torque Arm Grade

Enter the grade for the torque arm steel. Common values are A36 ksi or A572-50.

Torque Arm K Factor

Enter the buckling length K factor for the torque arm. Larger torque arms will usually contain interior bracing which will reduce the arm buckling length.

Torque Arm Bolt Size

Enter the nominal diameter of the bolt that is used.

Number Torque Arm Bolts

Enter the number of bolts used in the connection. When the connection is welded, enter zero. In design mode, the number entered is considered to be the minimum number of bolts to be used.

Tension Area Net Width Deduct Torque Arm

Towers that have bolted members that are in tension must use the net area to calculate the tension stress. Enter the net width of the member that should be subtracted to account for bolt holes. For angle members, the value is assumed to be the deduction for **one** connected leg of the angle. When the value is set to 0, the value will be calculated automatically from the bolt hole size + 1/16".

Tension U-Factor Torque Arm

The AISC specification requires that the net area calculation include a U-factor. See Chapter B3 of the AISC 9th Edition.

Pull Off Type

Select the steel shape type for the guy pull off members. Choices are limited to those shapes that are installed with the application. Standard types are flat bars, angles, double angles, channels, solid rounds and pipe. Guy pull offs always supersede any girts or horizontals that you had specified elsewhere.

Top and Bottom Pull Off Size

Select a size for the steel guy pull off member from the choices found in the list box. You may add or restrict which shapes by using the Database Editor. The bottom guy pull off is only applicable for torque arm mount types.

Pull Off Grade

Enter the grade for the guy pull off steel. Common values are A36 ksi or A572-50.

Is Strapping?

Guy pull offs are heavy horizontal members that help distribute the concentrated forces from the guy to the tower. Some manufacturers substitute a heavier horizontal member at the guy locations while others "strap" an additional horizontal piece around the outside while leaving the normal horizontal in place.

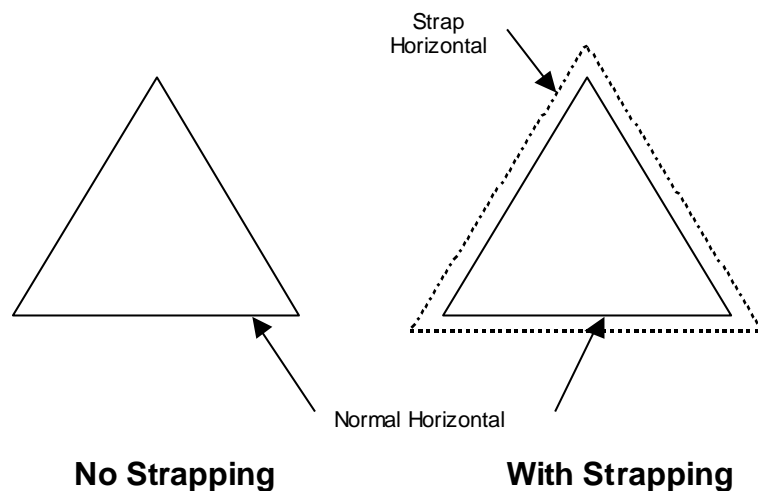

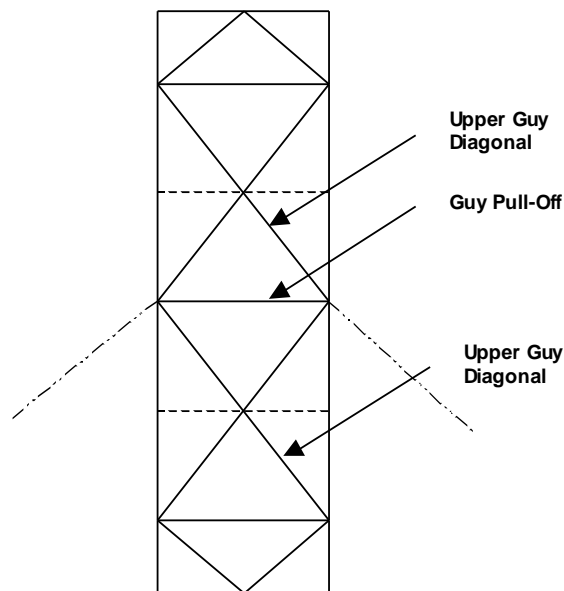

Pull Off K Factors

Enter the buckling length K factors, K_x , K_y , for the pull off.

Pull Off Bolt Size

Enter the nominal diameter of the bolt that is used.

Number Pull Off Bolts

Enter the number of bolts used in the connection. When the connection is welded, enter zero. In design mode, the number entered is considered to be the minimum number of bolts to be used.

Tension Area Net Width Deduct Pull Off

Towers that have bolted members that are in tension must use the net area to calculate the tension stress. Enter the net width of the member that should be subtracted to account for bolt holes. For angle members, the value is assumed to be the deduction for **one** connected leg of the angle. When the value is set to 0, the value will be calculated automatically from the bolt hole size + 1/16".

Tension U-Factor Pull Off

The AISC specification requires that the net area calculation include a U-factor. See Chapter B3 of the AISC 9th Edition.

Guy Diagonal Type

Guy diagonals are heavy diagonal members that help distribute the concentrated forces from the guy to the tower. The guy diagonals may be one panel above the guy location and/or one panel below the guy location. When a torque arm is specified, the upper and lower diagonals occur at both points on the tower where the torque arm meets the leg members. Select the steel shape type for the guy diagonal members. Choices are limited to those shapes that are installed with the

application. Standard types are flat bars, angles, double angles, channels, solid rounds and pipe. Guy diagonals always supersede any diagonals you had specified elsewhere.

Upper Guy Diagonal Size

Select a size for the upper steel guy diagonal member from the choices found in the list box. Leave this field blank if there is no need for an upper guy diagonal. The guy diagonal supersedes any other diagonal previously specified on the tower input spreadsheets. You may add or restrict which shapes by using the Database Editor.

Lower Guy Diagonal Size

Select a size for the lower steel guy diagonal member from the choices found in the list box. Leave this field blank if there is no need for a lower guy diagonal. The guy diagonal supersedes any other diagonal previously specified on the tower input spreadsheets. You may add or restrict which shapes by using the Database Editor.

Guy Diagonal Grade

Enter the grade for the guy diagonal steel. Common values are A36 ksi or A572-50.

Guy Diagonal K Factors

Enter the buckling length K factors, K_x, K_y, for the guy diagonals.

Guy Diagonal Bolt Size

Enter the nominal diameter of the bolt that is used.

Number Guy Diagonal Bolts

Enter the number of bolts used in the connection. When the connection is welded, enter zero. In design mode, the number entered is considered to be the minimum number of bolts to be used.

Tension Area Net Width Deduct Guy Diagonal

Towers that have bolted members that are in tension must use the net area to calculate the tension stress. Enter the net width of the member that should be subtracted to account for bolt holes. For angle members, the value is assumed to be the deduction for **one** connected leg of the angle. When the value is set to 0, the value will be calculated automatically from the bolt hole size + 1/16".

Tension U-Factor Guy Diagonal

The AISC specification requires that the net area calculation include a U-factor. See Chapter B3 of the AISC 9th Edition.

Insulators

Enter the number of guy insulators (if any) that are present on the guy.

Insulator Length

Enter the length of the guy insulator. This field may be left blank if there aren't any guy insulators.

Insulator Diameter

tnxTower calculates an equivalent wind area and equivalent ice weight and area by assuming that the insulator is an idealized cylinder. Enter the diameter that will approximate the wind area of the insulator.

Insulator Weight

Enter the weight of each insulator. tnxTower will calculate an equivalent uniform weight for the combination of guy and insulators.

Discrete Load Data

	Database	Description	Note/Carrier	Graphic Symbol	#	Face or Leg	Offset T
1		FV90	U.S. Cellular	<None>	9	C	None
2		Pirod 13' Low Profile Platform		<None>	1	C	None
3							
4							
5							
6							
7							
8							
9							
10							
11							
12							
13							
14							
15							
16							
17							
18							
19							
20							
21							

To delete any row, you may click on the row number and hit the delete key.

Inserting a row below the current is done in the same manner except that you key the insert key. When a row is inserted, the current row is copied down to the newly inserted row.

Deleting or inserting multiple rows may be accomplished by clicking and dragging the mouse up or down, or by using the shift or ctrl keys in combination with the left mouse button.

Copying, cutting and pasting may be accomplished by selecting the row and then using Ctrl+C (to copy), Ctrl+X (to cut) and Ctrl+V (to paste).

Descriptions that begin with an "*" will be assumed to be a comment.

Creating "what-if" scenarios is accomplished by disabling (turning off) or enabling (turning on) selected rows. This is done by selecting the row or rows to be toggled on or off, and then using the F4 function key (for multiple rows) or using the right mouse button (single row).

Summary

Discrete loads are forces being applied to the tower by appurtenances such as ladders, platforms, feedline bundles, specialized dishes, etc. They can either be concentrated at a point (same starting and ending height) or distributed over a distance as in the case of a feedline bundle.

Discrete Load Data

Discrete loads are entered through a spreadsheet control. You may create a library of pre-defined appurtenances using the Database editor. See Appurtenance Shapes. When entering discrete loads tnxTower will not allow you to have a load that overlaps both the lower and upper towers. This is done because the towers may have different number of faces.

Database

You may choose from a list of pre-defined appurtenance databases by using the drop-down list arrow.

Description

When you chose a database name, you may then choose from a list of pre-defined appurtenances by using the drop-down list arrow or you may simply type in a description if this is a custom appurtenance. Leaving the field blank will delete the entire discrete load entry.

Note/Carrier
Graphic Symbol

This field can be entered to track which carrier is assigned to this appurtenance.

Graphic symbols allow you to draw a symbolic representation of the appurtenance on the Material Take-off view (E-1). When you choose <None>, then no symbol will be added to the view. <AutoSense> will take data from the specified appurtenance database to draw the symbol. When data is not available, then the program will try to ascertain from the description what type of symbol to apply (i.e. "platform", or "stand-off"). Otherwise choose from the list of pre-defined symbols.

Appurtenances

Enter the number of appurtenances at this location. As an example, if you have 3 antennas at this location, enter the number 3 or use the spin button to specify 3.

Face or Leg

Choose the face or leg letter to which the appurtenance will be attached. For face and leg locations see Tower Type.

Offset Type

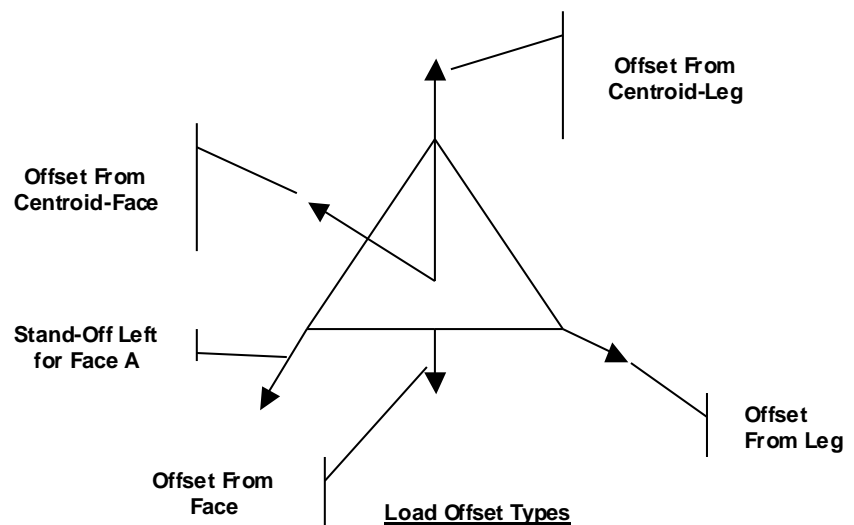

The types of offsets are:

- **None.** The appurtenance is assumed to be at the centroid of the tower. Appurtenances that have no offset will not have their areas projected on to the plane of the wind. Rather, the larger of the front face area or side face area will be used for all wind directions.
- **From Leg.** The appurtenance is mounted on the leg radiating out from the centroid and the distances are measured from the leg of the tower.
- **From Face.** The appurtenance is mounted at the midpoint of the face of the tower and the distances are measured from the face of the tower.
- **From Centroid-Leg.** The appurtenance is mounted on the leg radiating out from the centroid with the offset measured from the centroid of the tower.
- **From Centroid-Face.** The appurtenance is mounted at the midpoint of the face of the tower with the offset measured from the centroid of the tower.
- **Stand-Off Left.** The appurtenance is mounted on a stand-off that is parallel to the face specified. Left is the left side of the face as you are viewing the face from the centroid of the tower looking outward.

- **Stand-Off Right.** The appurtenance is mounted on a stand-off that is parallel to the face specified. Right is the right side of the face as you are viewing the face from the centroid of the tower looking outward.

Offset Distances

- **Horizontal Offset.** Enter the distance along a line from the centroid of the tower passing through the face or leg (depending upon the offset type). This offset is ignored for the None offset type. The offset is always positive and is assume to be radiating outward from the tower.
- **Lateral Offset.** Enter the distance transverse to the horizontal offset line. The value is clockwise positive right (+) or left (-). This value could be used to laterally position an antenna on a frame or boom gate.
- **Vertical Offset.** Enter the distance, above (+) or below (-) to the center of pressure of the appurtenance. When the antenna is mounted so that the center of pressure is at the appurtenance elevation specified, then the vertical offset is zero.

Azimuth Adjustment

Normally the appurtenance will be assumed to be aiming in a direction radiating outward from the tower. This angle is the amount that the angle needs to be adjusted for the particular antenna mount. This would normally only apply to a direction specific type of appurtenance, such as a microwave dish. Cell antennas normal would have a 0 angle adjustment. The angle is measured positive (+) in a clockwise direction.

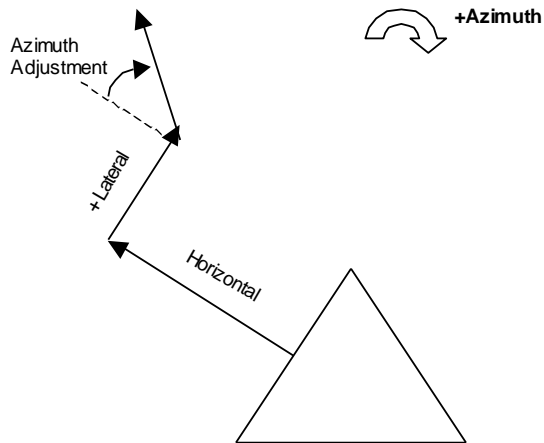

Offset Distances
Offset Face

Lateral offset is + to the right when viewing from the centroid of the tower

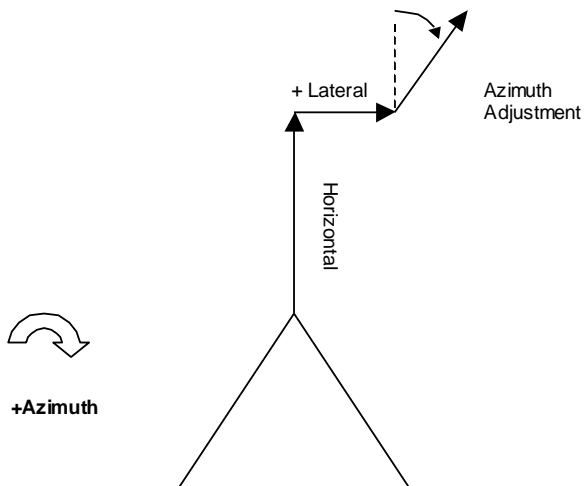

Offset Distances
Offset Leg

Lateral offset is + to the right when viewing from the centroid of the tower

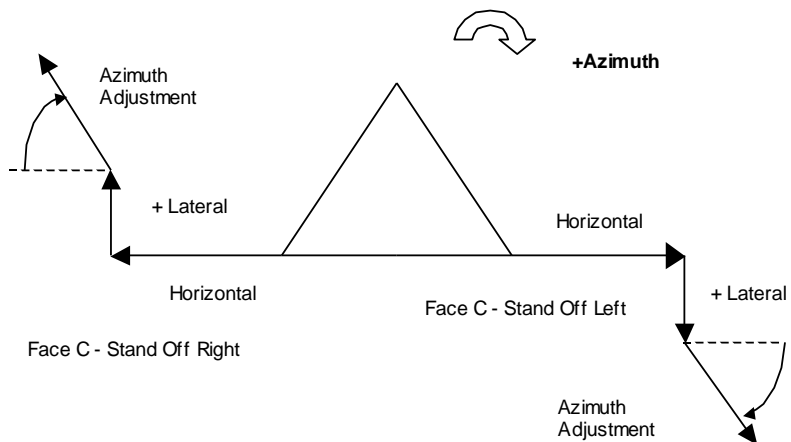

Offset Distances
Offset Stand-Off

Lateral offset is + to the right when viewing from the centroid of the tower

Start Height Above Base

Enter the starting height for the appurtenance. The start may be above or below the ending height. When the force is concentrated at a point, the starting and

ending heights should be the same. Concentrated forces may be placed above the top of the tower. Uniform forces will be truncated at the top of the tower.

End Height Above Base

Enter the ending height for the appurtenance. The end may be above or below the starting height. When the force is concentrated at a point, the starting and ending heights should be the same. Concentrated forces may be placed above the top of the tower. Uniform forces will be truncated at the top of the tower.

Shielding Factor Ka – no Ice

Enter a user-calculated value of Ka for no-ice loading condition. The value will be used by the program for all sections of the structure where the appurtenance is present. This option is available under TIA-222-G and TIA-222-H only.

Shielding Factor Ka – with Ice

Enter a user-calculated value of Ka for ice loading condition. The value will be used by the program for all sections of the structure where the appurtenance is present. This option is available under TIA-222-G and TIA-222-H only.

AutoCalc Ka

Select this option to have the program calculate Ka value automatically. It is assumed that the appurtenance is entirely within the face zone (TIA-222-G Figure 2-3, TIA-222-H Figure 2-5) or inside the cross section of the tower, and that subcritical flow is considered. For all other appurtenance locations/flow conditions, the Ka value must be set manually. This option is available under TIA-222-G and TIA-222-H only. Selecting this option will override any values in the **Shielding Factor Ka** columns. This option should not be selected for monopoles.

CaAa Front

Enter the value for the **total** CaAa on the front face of the appurtenance without ice and with ice. For distributed loads, tnxTower will take this total CaAa and divide it by the distance over which the load extends. When the load has an offset, the load will be projected in the direction of the wind vector.

Ice values require the entry of ½", 1", 2" and 4" ice. When the values for 1", 2" and 4" are unknown, enter the value for ½" and the other values will be automatically extrapolated.

CaAa Side

Enter the value for the **total** CaAa on the side face of the appurtenance without ice and with ice. When the appurtenance is circular, enter the same value as for the front face. A thin plate would have a value of 0 for the side face values. For distributed loads, tnxTower will take this total CaAa and divide it by the distance over which the load extends. When the load has an offset, the load will be projected in the direction of the wind vector.

Ice values require the entry of ½", 1", 2" and 4" ice. When the values for 1", 2" and 4" are unknown, enter the value for ½" and the other values will be automatically extrapolated.

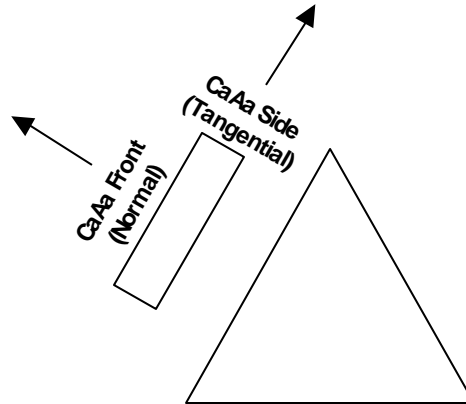

Front and Side Faces

Weight

Enter the value for the **total** weight without ice and with ice. For distributed loads, tnxTower will take this total weight and divide it by the distance over which the load extends. Ice values require the entry of ½", 1", 2" and 4" ice. When the values for 1", 2" and 4" are unknown, enter the value for ½" and the other values will be automatically extrapolated.

User Forces Data

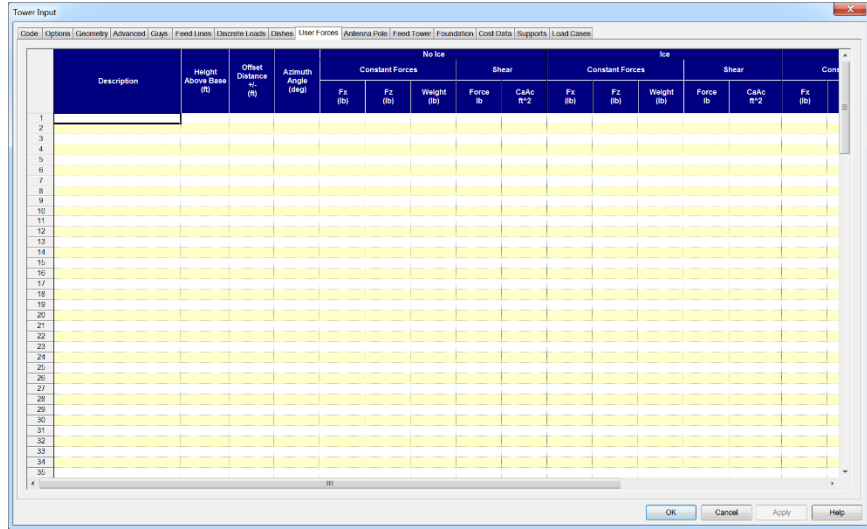

To delete any row, you may click on the row number and hit the delete key.

Inserting a row below the current row is done in the same manner except that you use the insert key. When a row is inserted, the current row is copied down to the newly inserted row.

Deleting or inserting multiple rows may be accomplished by clicking and dragging the mouse up or down, or by using the shift or ctrl keys in combination with the left mouse button.

Copying, cutting and pasting may be accomplished by selecting the row and then using Ctrl+C (to copy), Ctrl+X (to cut) and Ctrl+V (to paste).

Descriptions that begin with an "*" will be assumed to be a comment.

Creating "what-if" scenarios is accomplished by disabling (turning off) or enabling (turning on) selected rows. This is done by selecting the row or rows to be toggled on or off, and then using the F4 function key (for multiple rows) or using the right mouse button (single row).

Summary

User forces are entered directly as concentrated forces anywhere on the tower. The position of the load is described by an azimuth angle and an offset distance.

The azimuth angle is measure clockwise positive from the vertical in plan (-Z global axis). The offset is the radial distance from the centroid of the tower.

User Forces Data

User forces are entered through a spreadsheet control.

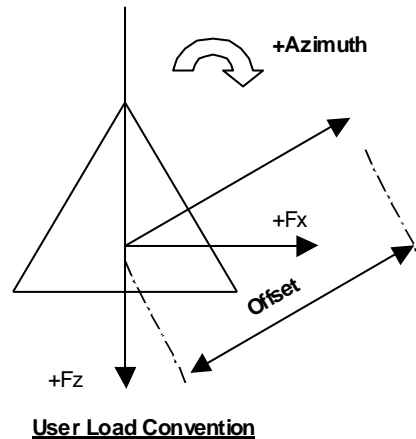

Description	Enter a description for the user force. Leaving the field blank will delete the entire user force entry.
Height Above Base	Enter the height for the load. The height may be above the top of the tower.
Offset Distance	Enter the radial offset. For poles, the offset is always measured from the center of the pole.
Azimuth Angle	Enter the azimuth angle. This number can be either positive (+) or negative (-).
Fx, Fz	Some towers may be subjected to forces that are constant regardless of the wind direction. Loran tower arrays, for example, will have cable drapes between multiple towers. The cable tensions result in forces that are independent of the wind direction.
Weight	Enter the weight component of the user forces.
Shear	For each wind load case, enter either the CaAc for the load or the force of the load. When a force is entered the program will zero out CaAc. The shear load is always assumed to act in the direction of the wind.
Seismic	Precalculated seismic force values can be entered as constant horizontal forces for the X and Z directions, vertical forces, and variable-direction horizontal forces (TIA-222-G and H only).
Ehx	Horizontal force value in the global X direction. This force will remain unchanged in all load combinations.
Ehz	Horizontal force value in the global Z direction. This force will remain unchanged in all load combinations.
Ev	Vertical force value in the global Y direction. This force will be taken as positive or negative, depending on the load combination. This input is not available under TIA-222-G, unless the Use ASCE 7-10 seismic load combinations option is selected on the Code page.
Eh	Variable-direction horizontal force. The directions considered will correspond to the No Ice wind directions selected on the Options page.

Feed Tower Data

	Description	Start Height Above Base (ft)	End Height Above Base (ft)	Tower Moment of Inertia (in ⁴)	Number of Sections Between Supports	Cable Grade	Cable Size	CaAa No Ice (ft ² ft)	Ca 1/2 (ft ²)
1	20' Face Feed Tower	240.000	0.000	4329.450	1	EHS	5/8	10.2999977	10.45
2									
3									
4									
5									
6									
7									
8									
9									
10									
11									
12									
13									
14									
15									
16									
17									
18									
19									
20									
21									

To delete any row, you may click on the row number and hit the delete key. Inserting a row below the current is done in the same manner except that you key the insert key. When a row is inserted, the current row is copied down to the newly inserted row. Deleting or inserting multiple rows may be accomplished by clicking and dragging the mouse up or down, or by using the shift or ctrl keys in combination with the left mouse button. Copying, cutting and pasting may be accomplished by selecting the row and then using Ctrl+C (to copy), Ctrl+X (to cut) and Ctrl+V (to paste).

Summary

A feed tower is a small inner tower that runs up the center of the lower tower. It is intended to provide a means of running feed lines or ladders up the tower. The feed tower is attached to the main tower with cables at every section. When the feed tower does not extend to the ground, a grillage of supporting elements is generated at the base of the feed tower. The tower is treated as an arbitrary member rather than as a complete tower within itself. The supporting members are treated as an index plate and neither the feed tower nor the supporting members are not designed or checked. However, the forces on the tower will be printed out in the reports under the Maximum Forces table. Feed tower loads are calculated separate from the main tower and applied only to the feed tower itself.

Feed Tower Data

Feed tower data are entered through a spreadsheet control.

Description

Enter a description for the row. Leaving the field blank will delete the entire entry.

Start Height Above Base

Enter the starting height for the feed tower section. The start may be above or below the ending height.

End Height Above Base

Enter the ending height for the feed tower section. The end may be above or below the starting height.

Tower Moment of Inertia

Enter the moment of inertia of the tower section.

***Number of Sections
Between Support***

Ordinarily, cable supports occur at every section. However, when the tower is split into panels, the supports may need to be positioned further apart than at each section.

Cable Grade

Choose the cable type, EHS, BS, or UHS. Choices are limited to those shapes that are installed with the application. Feed tower cables are given a minimal initial tension of 1.5%.

Cable Size

Select a size for the steel cables from the choices found in the list box. You may add or restrict which sizes by using the Database Editor. Feed tower cables are given a minimal initial tension of 1.5%.

CaAa

Enter the value for CaAa per unit length of the feed tower without ice and with ice.

Weight

Enter the value for the weight per unit length of the feed tower without ice and with ice.

Antenna Pole Data

Antenna poles are mounted above the main tower and latticed pole tower. The pole may have a beacon attached to the top of the pole. The antenna pole data may be entered in one of three ways:

- **Force-Couple.** Forces are pre-calculated by the user and entered directly into the program.
- **Pole Forces.** The antenna pole geometry is entered and any loads on the pole are entered as forces.
- **Pole CaAa.** The antenna pole geometry is entered and any loads on the pole are entered as exposed wind area.

Pole Properties

Pole properties consist of the pole length, the pole moment of inertia, I_x and I_y , and the pole modulus of elasticity (Young's modulus, E).

Pole Forces

Weight

Enter the value for the weight per unit length of the pole without ice and with ice.

Wind

Enter the value for the wind force per unit length of the pole without ice, with ice, and for service conditions. The option is only available if you specified Pole Forces.

CaAa

Enter the value for the exposed wind area per unit length of the pole without ice and with ice. The option is only available if you specified Pole CaAa.

Beacon Forces

Beacon Length

Enter the diameter or height of the beacon.

Weight

Enter the value for the weight of the beacon without ice and with ice.

Wind

Enter the value for the wind force of the beacon without ice and with ice. The option is only available if you specified Pole Forces.

CaAa

Enter the value for the exposed wind area of the beacon without ice and with ice. The option is only available if you specified Pole CaAa.

Force-Couple

The optional force-couple information is provided for those towers that might have a special upper tower configuration that is not modeled within `tnxTower` but from which there are vertical forces, shears, and overturning moments. The shear and moment entered are always assumed to be acting in the direction of the wind for any particular load case. The force-couple is always applied to the very top of the entire tower structure.

Feed Line Load Data

	Database	Description	Note/Carrier	#	Face	Component Type	Allow Shielding	Start Height Above Base (ft)
1	helix-hj	1 5/8	U.S. Cellular	9	C	Ar (CfAe)	<input type="checkbox"/>	0.00
2	helix-hj	1 5/8	Nextel	9	C	Ar (CfAe)	<input checked="" type="checkbox"/>	100.00
3							<input type="checkbox"/>	
4							<input type="checkbox"/>	
5							<input type="checkbox"/>	
6							<input type="checkbox"/>	
7							<input type="checkbox"/>	
8							<input type="checkbox"/>	
9							<input type="checkbox"/>	
10							<input type="checkbox"/>	
11							<input type="checkbox"/>	
12							<input type="checkbox"/>	
13							<input type="checkbox"/>	
14							<input type="checkbox"/>	
15							<input type="checkbox"/>	
16							<input type="checkbox"/>	
17							<input type="checkbox"/>	
18							<input type="checkbox"/>	
19							<input type="checkbox"/>	
20							<input type="checkbox"/>	
21							<input type="checkbox"/>	

To delete any row, you may click on the row number and hit the delete key.

Inserting a row below the current is done in the same manner except that you key the insert key. When a row is inserted, the current row is copied down to the newly inserted row.

Deleting or inserting multiple rows may be accomplished by clicking and dragging the mouse up or down, or by using the shift or ctrl keys in combination with the left mouse button.

Copying, cutting and pasting may be accomplished by selecting the row and then using Ctrl+C (to copy), Ctrl+X (to cut) and Ctrl+V (to paste).

Descriptions that begin with an "*" will be assumed to be a comment.

Creating "what-if" scenarios is accomplished by disabling (turning off) or enabling (turning on) selected rows. This is done by selecting the row or rows to be toggled on or off, and then using the F4 function key (for multiple rows) or using the right mouse button (single row).

Summary

This sheet is used for entering linear appurtenances and feed lines. Feed lines, also known as coax cables, are conduits for carrying electrical signals to the various antennae, dishes etc. located on the tower.

Please note that any feed line grouping considerations, such as number and configuration of lines, cluster treatment, etc. are applied separately to feed lines entered in each spreadsheet row. Therefore, feed lines from different input rows will not be combined for calculations of cluster EPA's, even if they are specified for identical elevations and faces of the tower.

Feed Line Load Data

Feed line loads are entered through a spreadsheet control. To delete a row you may leave the description blank, or you may select one or more rows using the mouse and then hitting the delete key. You may create a library of pre-defined feed lines using the Database editor. See Feed Line Shapes. When entering feed line loads tnxTower will not allow you to have a load that overlaps both the lower and upper towers. This is done because the towers may have different number of faces.

Database

You may choose from a list of pre-defined feed line databases by using the drop-down list arrow.

Description

When you chose a database name, you may then choose from a list of pre-defined feed lines by using the drop-down list arrow or you may simply type in a description if this is a custom feed line. Leaving the field blank will delete the entire feed line entry.

Note/Carrier

This field can be entered to track which carrier is assigned to this feed line.

Feedlines

Enter the total number of feed lines at this location. As an example, if you have 3 feed lines at this location, enter the number 3 or use the spin button to specify 3.

Face

Choose the face letter to which the feed line will be attached. For face locations see Tower Type. Assigning a face is only valid when treating the linear appurtenance as a structural component (Ar or Af).

**Component Type
(lattice towers)**

The TIA/EIA standard allows feed line attached to the face to be considered in the calculation for area of structural shapes. When they are not attached to the face, they must be treated as appurtenances. tnxTower allows the user to control this behavior by defining the following types for use in EIA section 2.3.2:

- **Ar (CfAe).** Treated as a structural round member. The feed line must be in the face. This option is not available under TIA-222-G or TIA-222-H.
- **Af (CfAe).** Treated as a structural flat member. The feed line must be in the face. This option is not available under TIA-222-G or TIA-222-H.
- **Ar (CaAa).** Treated as an appurtenance in the face but entered using the diameter of the line rather than as an area. Ca is automatically set to 1.2 when calculating the CaAa area under all codes except TIA-222-G and TIA-222-H. For TIA-222-G or TIA-222-H, the Ca value is set as follows:
 - when all feed lines are placed in a single row, Ca is determined based on Table 2-8 (TIA-222-G) or Table 2-9 (TIA-222-H),
 - when feed lines are placed in a cluster, the Ca value is assumed to be 1.2 if the group is treated as a sum of individual lines, and 1.5, if the feed lines are represented by an equivalent rectangular appurtenance.
- **Af (CaAa).** Treated as an appurtenance in the face but entered using the width of the line rather than as an area. This option is only available under TIA-222-G and TIA-222-H. Ca value is set as follows:
 - when all feed lines are placed in a single row, Ca is determined based on Table 2-8 (TIA-222-G) or Table 2-9 (TIA-222-H),
 - when feed lines are placed in a cluster, the Ca value is assumed to be 2.0 if the group is treated as a sum of individual lines, and 1.5, if the feed lines are represented by an equivalent rectangular appurtenance.
- **Ar (Leg).** Treated as a structural round member. The feed line must be in the face near the leg specified. The area is distributed to both adjacent faces of the tower. This option is not available under TIA-222-G or TIA-222-H.

- **Af (Leg).** Treated as a structural flat member. The feed line must be in the face near the leg specified. The area is distributed to both adjacent faces of the tower. This option is not available under TIA-222-G or TIA-222-H.
- **CaAa (In Face).** Treated as an appurtenance that is in the face and subject to the 2.0 Ag limitation rule. Example: 1.58" diameter round feed line would be $1.58 * 1.2 / 12 = .158 \text{ ft}^2/\text{ft}$ (without ice). In the face usually means that the appurtenance is within the projected width of the face and no farther than 12" or the face width / 5 (whichever is greater) from the face of the tower.
- **CaAa (Out Of Face).** Treated as an appurtenance that is not in the face and therefore not subject to the 2.0 Ag limitation rule. Example: 1.58" diameter round feed line would be $1.58 * 1.2 / 12 = .158 \text{ ft}^2/\text{ft}$ (without ice).
- **Truss-Leg.** The feed lines are assumed to run up the truss legs of the tower. This option is not available under TIA-222-G or TIA-222-H.

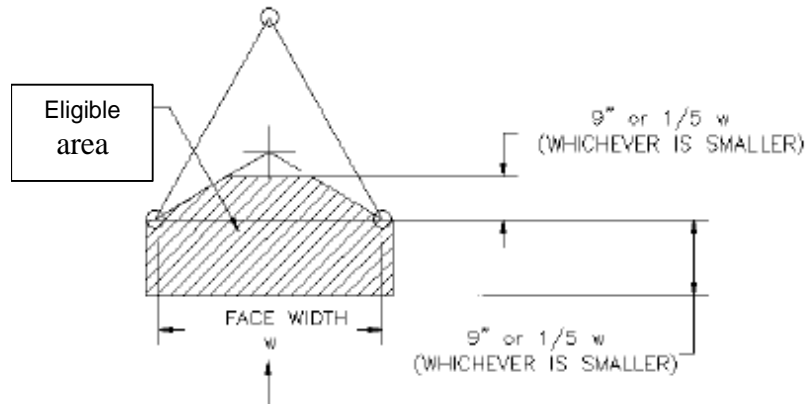

Definition of "In the face" (TIA/EIA-222-F and earlier)

Component Type (monopoles)

Feed lines attached to monopole surfaces are treated as appurtenances. Feed lines placed inside monopoles add to the weight of the structure only (concentric location assumed). The following types are available:

- **CaAa (Out Of Face).** Treated as an appurtenance that is entirely external to the structure. No shielding effects exist, and feed line projected areas are not affected by the presence of the monopole. The projected area of the line is entered directly as its CaAa value.
- **Surface Ar (CaAa).** Treated as a round linear appurtenance attached to the surface of the pole. For TIA-222-G and TIA-222-H the EPA is calculated based on the **Feed Line Cluster Treatment** column setting. For other standards the projected area is based on the total area of all feed lines specified with the force coefficient taken as 1.2.
- **Surface Af (CaAa).** As above, but treated as a flat linear appurtenance.

- **Inside Pole.** This option will zero out the CaAa fields and will insure that the weight of the line with ice is identical to the weight without ice.

These feed line types are also available for poles mounted on top of the base tower. However, for the **Surface Ar (CaAa)** and **Surface Af (CaAa)** types, the **Perimeter Offset** settings are not available, and the feed lines are assumed at the center of the sector in which they are located.

Feed Line Cluster Treatment (lattice towers)

This input option is available under TIA-222-G and TIA-222-H, for feed lines type Ar (CaAa) and Af (CaAa) only.

For calculation of the projected area, lines mounted in groups may be treated individually or as equivalent appurtenances (2.6.9.5). For each row of input the user needs to specify how feed lines entered in that row are treated. The available choices are:

- **Individual Lines .** EPA for each line is calculated using values from Table 2-8 (TIA-222-G) or Table 2-9 (TIA-222-H) of the Standard. The calculated total EPA for the row is constant for all wind directions and equal to the sum of EPAs of all feed lines entered in that row. If, for ice conditions, the ice bridges the gaps between the feed lines, a rectangular bundle is assumed with the Ca of 1.5. The EPA of that bundle is constant for all wind directions and based on the maximum dimensions (height x plan section diagonal).

The weight is calculated using the actual number of feed lines. For ice conditions, the additional weight of ice is either the weight of the solid ice block or the total weight of ice on individual feed lines, depending on whether or not ice bridging occurs. See Figure 2-12 (TIA-222-G) or Figure 2-14 (TIA-222-H).

- **Rectangular Appurtenance.** EPA is calculated for an equivalent rectangular appurtenance with the Ca of 1.5 (for no ice and ice conditions). The normal and transverse sides of the equivalent appurtenance are determined from values entered for the feed line diameter, spacing, and number of rows and columns. The EPA calculation considers orientation of the equivalent appurtenance faces to wind directions for each load case.

The weight is calculated using the actual number of feed lines. For ice conditions, the additional weight of ice is either the weight of the solid ice block or the total weight of ice on individual feed lines, depending on whether or not ice bridging occurs. See Figure 2-12 (TIA-222-G) or Figure 2-14 (TIA-222-H).

- **Automatic Individual Line or Rectangular Appurtenance.** The program will calculate both the Individual Lines and Rectangular Appurtenance EPAs and automatically select the smaller EPA value for each wind direction.
- **Round Appurtenance.** EPA is calculated for an equivalent round appurtenance with the Ca of 1.2 (1.5 for ice conditions). The EPA is based on the entered value of **Round Cluster Dia.** The quantity, individual diameter, and spacing of feed lines are ignored for the EPA calculation.

The weight is calculated using the actual number of feed lines. For ice conditions, the additional weight of ice is the smaller value of the solid

ice block and total ice on individual feed lines. See Figure 2-12 (TIA-222-G) or Figure 2-14 (TIA-222-H).

Feed Line Cluster Treatment (monopoles)

This input option is available under TIA-222-G and TIA-222-H, for monopole feed lines type **Surface Ar (CaAa)** and **Surface Af (CaAa)** only.

In the calculation of the EPA, the program will only consider lines that are on the outside of the contour of the pole, for a given wind direction. Weight calculations (including ice, if applicable) include all feed lines specified. For each row of input the user needs to specify how feed lines entered in that row are treated. The available choices are:

- **Individual Lines.** This option is often overly conservative. Although the program will ignore areas of feed lines that are on the windward and leeward sides of the pole, areas of all individual lines projecting outside of the contour of the pole (for a given wind direction) will be included. The Ca used to calculate the EPA is 1.2 and 2.0 for **Surface Ar (CaAa)** and **Surface Af (CaAa)** feed line types, respectively. The projected area is based on the diameter or larger cross-sectional dimension of the line, as applicable. Ice accumulation without ice bridging effects is considered.
- **Side Projected Area.** The program will calculate the EPA of the group of lines overall protruding outside of the pole contour. If lines are attached to the pole with an offset, the resulting increase of the area will also be included. The Ca value used is 1.5.

Allow Shielding

Check mark if the linear appurtenance can shield the steel in the face of the tower. This would typically require that the feed lines be within 2 diameters of the face of the tower. This option allows applies to feed lines considered as Ar, Af, or Ar (CaAa).

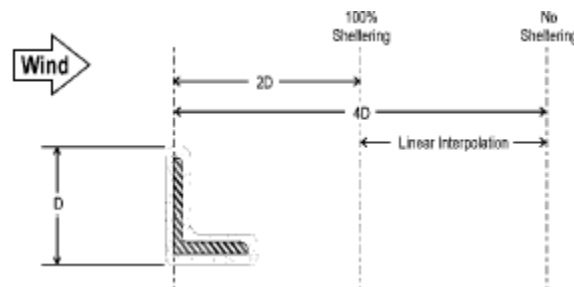

Object must be within 2D of face for full shielding

Exclude From Global Torque Calculation

The eccentricity of the feed line tributary wind force will not be considered in the calculation of the global tower torque. This setting is only available when the **Consider Feed Line Torque** checkbox on the Options page is selected (unselecting **Consider Feed Line Torque** overrides any torque calculation selection made on the Feed Lines page).

Start Height Above Base

Enter the starting height for the feed line. The start may be above or below the ending height.

End Height Above Base

Enter the ending height for the feed line. The end may be above or below the starting height. Feed lines extend above the top of the tower will be truncated. When there is an upper-latticed pole on top of a main tower, the feed lines will be truncated at the index plate. This is done because the upper pole may have a different number of faces than the main tower.

Perimeter Offset Start (monopoles only)

Perimeter Offset Start and **Perimeter Offset End** indicate the location of the feed line group in plan, along pole's circumference, within a sector (A, B, C, or D). The values for the **Start** and the **End** are equal to the ratios of the pole perimeter arcs occupied by the feed lines to the sector's arc length (1/3 or 1/4 of the pole perimeter). The arcs start at the center of the sector, and the **Start/End** values are positive for locations clockwise from the center. The **Start/End** values are also equal to the ratios of corresponding angular dimensions. Refer to the diagram below for further details.

Perimeter Offset End (monopoles only)

See **Perimeter Offset Start** above.

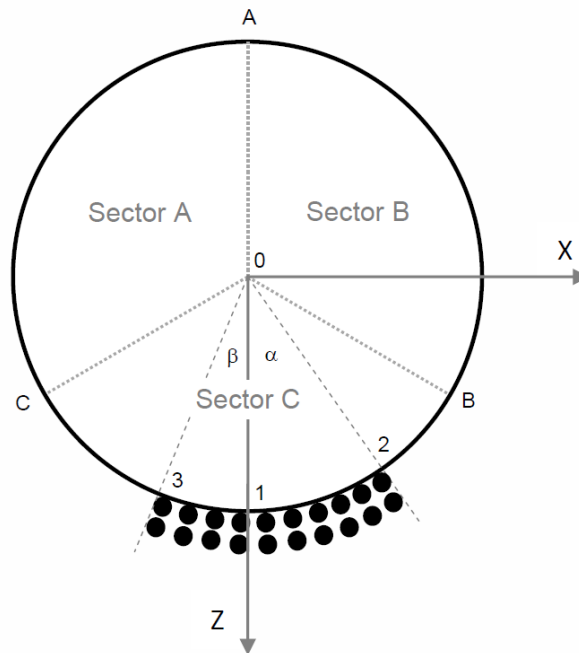

Perimeter Offsets for monopole feed lines.

Data entry for feed lines located in Sector C:

- Center of Sector C arc: Pt. 1
- Start Offset: from Pt. 1 to Pt. 2(S12)
- End Offset: from Pt. 1 to Pt.3 (S13)
- Sector C arc: from B to C (SBC)

Enter Offsets as ratios:

Perimeter Offset Start: $S_{12} / S_{BC}(-ve)$

Perimeter Offset End: $S_{13} / S_{BC}(+ve)$

Alternatively:

Perimeter Offset Start: $\alpha / 120^\circ (-ve)$

Perimeter Offset End: $\beta / 120^\circ (+ve)$

Face Offset

This option will only appear when you have chosen the option to **Consider Feedline Torque** on the Options sheet. This face offset determines the clear distance from the centerline of the face of the tower to the outside edge of the feed line. When the distance is negative (-), the feed line is positioned to the inside of the tower face. When it is set to 0 or a positive number, it is positioned to the outside of the tower face. Feed lines assumed mounted to a leg, such as CaAa (Out of Face), Ar (Leg), Af (Leg) and Truss-Leg, cannot have a face offset.

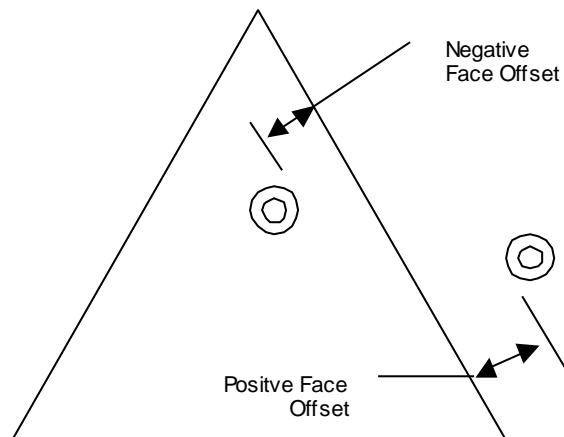

Lateral Offset (Frac of Face Width)

This option will only appear when you have chosen the option to **Consider Feedline Torque** on the Options sheet. Feedline ladders will often parallel the tower legs. Since the legs are not vertical on self-supporting towers, the lateral offset is entered as a fraction of the face width of the tower. The default location (0) is the center of the face for most feedline types. Offsets are lateral and can range from -.5 (to the left of center) up to +.5 (to the right of center). A value of .5 would position the feedline at the leg location. The fraction is multiplied by the face width of the tower when calculating the equivalent center of pressure. The value is positive to the right when looking from the centroid of the tower out toward the face where the feedlines are positioned.

For feedline types Ar (Leg), Af (Leg) and CaAa (Out of Face), the lateral offset is considered to be from the leg in a direction radiating from the centroid of the tower. The fraction in these cases is always positive originating from the leg. Ar

(Leg) and Af (Leg) types are positioned to the inside of the tower while the CaAa (Out of Face) type is positioned to the outside of the tower. Truss leg feedlines are always considered to be located at the centroid of the truss leg. Inside Pole types cannot be offset.

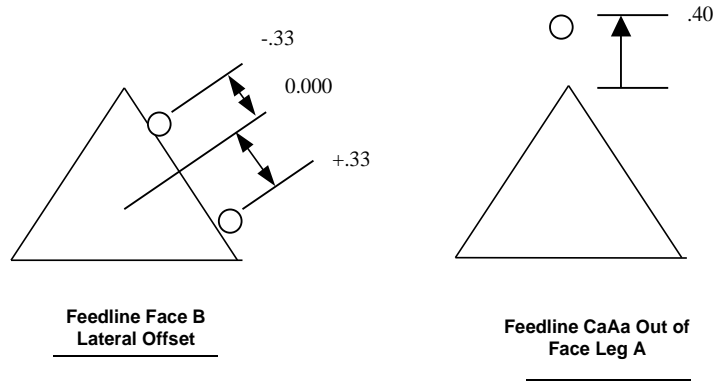

Number Per Row

This entry will usually default to the total number of lines. Many times feed lines are stacked in multiple rows. For instance, if there are 11 feed lines, 4 in the first row, 4 in the second row and 3 in the third row, then there are two full rows and one partial. In this case, you would enter the value of 4 lines per row. The program will then calculate the necessary shielding and total ice weight checking to see if the bundle becomes solid with ice.

Clear Spacing
Row Clear Spacing

Enter the clear distance that separates the feed lines along the face of the tower.
When there is more than one row of feedline (stacked), then enter the clear distance that separates the rows of lines.

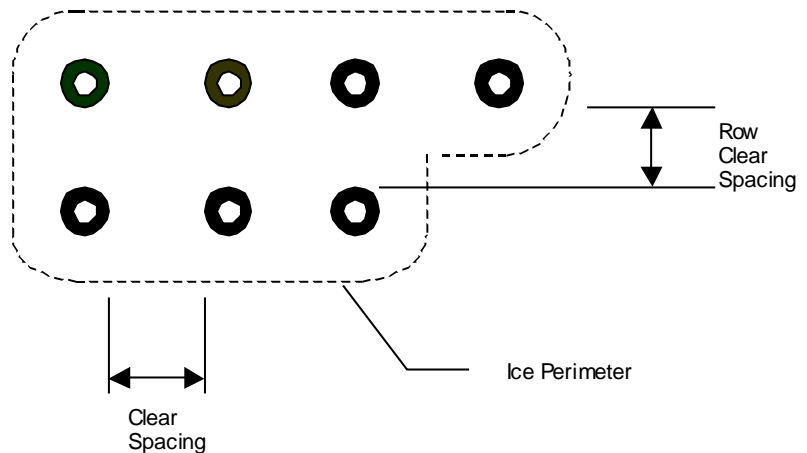

Feed Line Stacking

Round Cluster Dia.

Available under TIA-222-G and TIA-222-H only. This number is used for the calculation of EPA of feed lines treated as round equivalent appurtenances. It is

the no-ice outer diameter of the cluster, increased by 2 x ice thickness for ice condition. The **Feed Line Cluster Treatment** must be set to **Round Appurtenance** to enable data entry in this column. See Figure 2-12 (TIA-222-G) or Figure 2-14 (TIA-222-H).

Flat Attachment Effective Width Ratio

Enter the ratio of the effective width of the flat attachment to the total width of the attachment.

TIA-222-H-1, Table 2-8a, Note 3 allows to ignore the width of flat plates attached to the structure within the flat width of multi-sided monopole shafts in the Windward Zone. This reduction applies only to attachments that are placed directly on flat sides of the shaft. Accordingly, the program gives the user the ability to define the effective width of the attachment, i.e., the portion of its width that projects beyond the limits of the flat side of the shaft. If the attachment projects on both sides of the flat side, the assumed effective width is the total of both projections.

For a flat attachment placed directly on the flat side of the shaft, the Effective Width Ratio would normally be less than 1.0. However, the user may enter the ratio as 1.0 (or any other positive number) if the attachment is not placed directly on the flat side of the shaft or for other reasons.

Because the width of the flat side of the polygonal cross-section varies for tapered shafts, the value entered should be an average ratio within the length of the attachment. To increase the accuracy of the data, the user may split the length of the attachment into shorter segments and enter different ratios for each segment. This option is available under TIA-222-H only.

AutoCalc Flat Attachment Effective Width

You may select this option for flat attachments placed directly on flat sides of the shaft to have the program automatically calculate the effective width of the attachments. The effective width assumed by the program is the difference between the specified width of the attachment and the average width of the flat side of the shaft within the length of the attachment. Please note that the **Outside And Inside Corner Radii Are Known** setting will have an impact on the assumed width of the flat side. Selecting this option will override any value entered in the **Flat Attachment Effective Width Ratio** column.

Shielding Factor Ka – no Ice

Enter a user-calculated value of Ka for no-ice loading condition. The value will be used by the program for all sections of the structure where the feed line is present. This option is available under TIA-222-G and TIA-222-H only.

Shielding Factor Ka – with Ice

Enter a user-calculated value of Ka for ice loading condition. The value will be used by the program for all sections of the structure where the feed line is present. This option is available under TIA-222-G and TIA-222-H only.

AutoCalc Ka

Select this option to have the program calculate Ka value for all tower sections where the feed line is present. It is assumed that the feed line is entirely within the face zone (TIA-222-G Figure 2-3, TIA-222-H Figure 2-5) or inside the cross section of the tower. For all other feed line locations, the Ka value must be set manually. This option is available under TIA-222-G only. Selecting this option will override any values in the **Shielding Factor Ka** columns. This option should not be selected for monopoles.

CaAa

For feedlines treated as CaAa in the face or out of the face, enter the value for the CaAa per unit distance on the specified face of the appurtenance without ice and with ice.

Ice values require the entry of ½", 1", 2" and 4" ice. When the values for 1", 2" and 4" are unknown, enter the value for ½" and the other values will be automatically extrapolated.

Feedlines that run inside of monopoles should have their CaAa set to 0.

Weight

Enter the value for the weight per unit distance without ice and with ice. Ice values require the entry of ½", 1", 2" and 4" ice. When the values for 1", 2" and 4" are unknown, enter the value for ½" and the other values will be automatically extrapolated. Feedlines that run inside of monopoles should have the weight with ice set to be the same as the weight without ice.

Dish Data

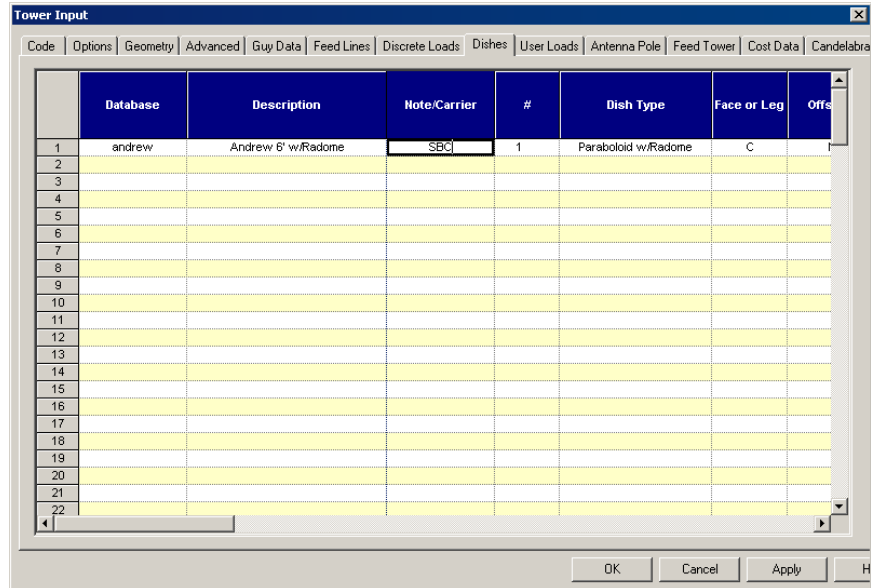

To delete any row, you may click on the row number and hit the delete key.

Inserting a row below the current is done in the same manner except that you key the insert key. When a row is inserted, the current row is copied down to the newly inserted row.

Deleting or inserting multiple rows may be accomplished by clicking and dragging the mouse up or down, or by using the shift or ctrl keys in combination with the left mouse button.

Copying, cutting and pasting may be accomplished by selecting the row and then using Ctrl+C (to copy), Ctrl+X (to cut) and Ctrl+V (to paste).

Descriptions that begin with an "*" will be assumed to be a comment.

Creating "what-if" scenarios is accomplished by disabling (turning off) or enabling (turning on) selected rows. This is done by selecting the row or rows to be toggled on or off, and then using the F4 function key (for multiple rows) or using the right mouse button (single row).

Summary

Dishes may be directed to any azimuth. The azimuth will be ignored if the offset is set to None or if the Use Dish Coefficients option is turned off.

Dish Data

Dishes are entered through a spreadsheet control. To delete a row you may leave the description blank, or you may select one or more rows using the mouse and then hitting the delete key. You may create a library of pre-defined dishes using the Database editor. See Dish Shapes.

Database

You may choose from a list of pre-defined dish databases by using the drop-down list arrow.

Description

When you chose a database name, you may then choose from a list of pre-defined dishes by using the drop-down list arrow or you may simply type in a description if this is a custom dish. Leaving the field blank will delete the entire dish entry.

Note/Carrier

Dishes

Face or Leg

Offset Type

This field can be used to track which carrier is assigned to this dish.

Enter the number of dishes at this location. As an example, if you have 3 dishes at this location, enter the number 3 or use the spin button to specify 3.

Choose the face or leg letter to which the dish will be attached. For face and leg locations see Tower Type.

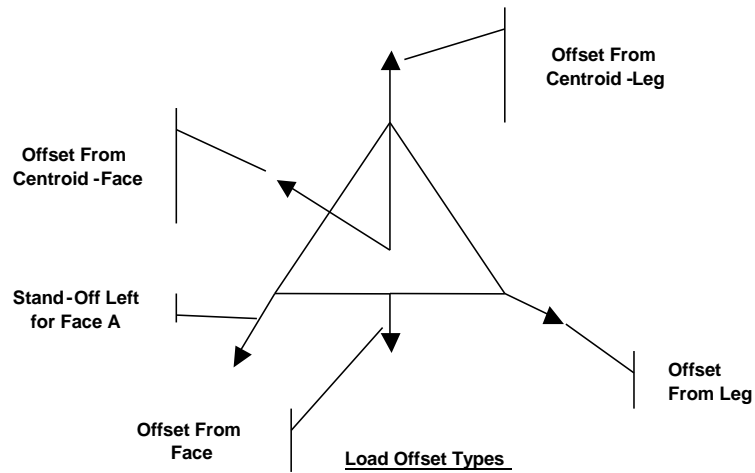

The types of offset are:

- **None.** The appurtenance is assumed to be at the centroid of the tower without any azimuth adjustment.
- **From Leg.** The appurtenance is mounted on the leg radiating out from the centroid.
- **From Face.** The appurtenance is mounted at the midpoint of the face of the tower.
- **From Centroid-Leg.** The appurtenance is mounted on the leg radiating out from the centroid with the offset measured from the centroid of the tower.
- **From Centroid-Face.** The appurtenance is mounted at the midpoint of the face of the tower with the offset measured from the centroid of the tower.
- **Stand-Off Left.** The appurtenance is mounted on a stand-off that is parallel to the face specified. Left is the left side of the face as you are viewing the face from the centroid of the tower looking outward.
- **Stand-Off Right.** The appurtenance is mounted on a stand-off that is parallel to the face specified. Right is the right side of the face as you are viewing the face from the centroid of the tower looking outward.

Offset Distance

- **Horizontal Offset.** Enter the distance along a line from the centroid of the tower passing through the face or leg (depending upon the offset

type). This offset is ignored for the None offset type. The offset is always positive and is assume to be radiating outward from the tower.

- **Lateral Offset.** Enter the distance transverse to the horizontal offset line. The value is clockwise positive right (+) or left (-). This value could be used to laterally position a dish on the mount.
- **Vertical Offset.** Enter the distance, above (+) or below (-) to the center of pressure of the dish. When the dish is mounted so that the center of pressure is at the mount elevation specified, then the vertical offset is zero.

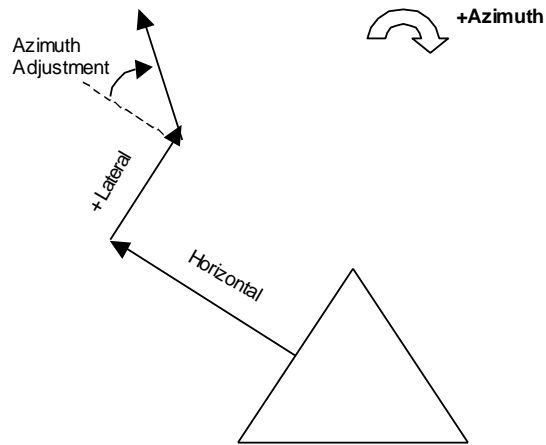

Offset Distances
Offset Face

Lateral offset is + to the right when viewing from the centroid of the tower

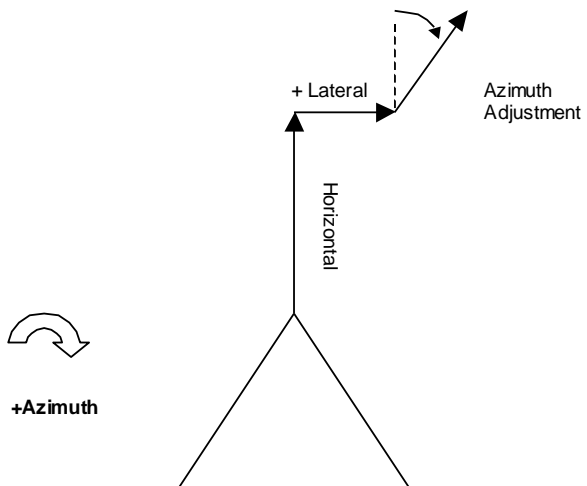

Offset Distances
Offset Leg

Lateral offset is + to the right when viewing from the centroid of the tower

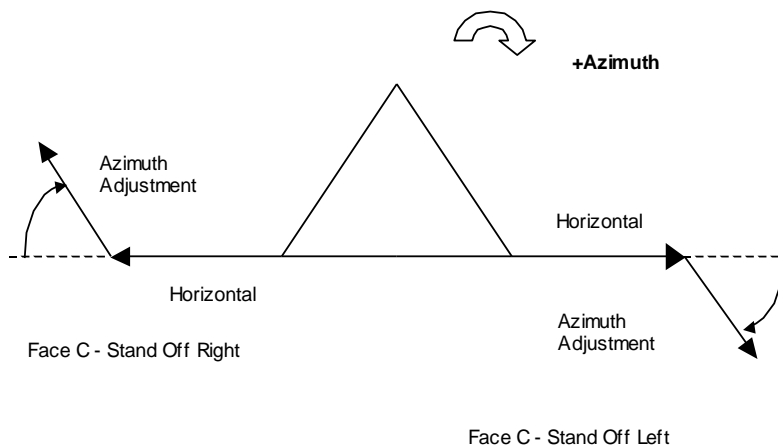

Offset Distances
Offset Stand-Off

Lateral offset is + to the right when viewing from the centroid of the tower

Azimuth Adjustment

Normally the dish will be assumed to be aiming in a direction radiating outward from the tower. This angle is the amount that the angle needs to be adjusted for the particular dish aiming direction. The angle is positive clockwise.

3 dB Beam Width

Parabolic antennas and reflectors have a 3 dB beam width at 2Θ at half-power (HP). Table C of 222-F contains allowable twist and sway values for dishes. When a value is entered in this field, the program will print out an allowable value from Table C in the critical deflections table. Leave the value 0 if you do not desire any check of the twist and sway.

Height Above Base

Enter the height for the dish. The height may be above the top of the tower.

Outside Aperture Area

Enter the area of the dish. When you leave this field blank, then the program will later calculate the area from the diameter.

Outside Diameter

Enter the diameter of the dish. When you leave this field blank, then the program will later calculate the diameter from the area assuming a circular dish.

Weight

Enter the value for the weight without ice and with ice. Ice values require the entry of ½", 1", 2" and 4" ice. When the values for 1", 2" and 4" are unknown, enter the value for ½" and the other values will be automatically extrapolated.

Foundation Data

Tower Input

Code | Options | Geometry | Advanced | Guy Data | Feed Lines | Discrete Loads | Dishes | User Loads | Antenna Pole | Feed Tower | **Foundation** | Cost Data

Base Plate

Base Plate Is Square Grouted

Anchor Bolt Grade: F1554-36

Anchor Bolt Size: 1.500 in

Number Of Bolts: 24

Embedment Length: 24.000 in

28 Day Strength, f'c: 4.000 ksi

Grout Space: 2.000 in

Base Plate Grade: A572-50

Base Plate Thickness: 1.500 in

Bolt Circle Diameter: 62.000 in

Outer Diameter/Width: 72.000 in

Inner Diameter/Width: 42.000 in

Clipped Corner: 0.000 in

Base Plate Type: Plan Plate

Bolts Per Stiffener: 1

Stiffener Thickness: 0.000 in

Stiffener Height: 0.000 in

OK Cancel Apply Help

Summary

The foundation sheet enables entry of monopole base plate data. The base plate will be checked or designed (if Design Mode is set to Cyclic Design) whenever the plate thickness and bolt circle values are non-zero.

Base Plate Is Square

Square base plates are rare and usually have only enough space to accommodate 4 or 8 bolts. When this box is unchecked, the base plate will be either polygonal (for tapered polygonal monopoles) or circular (for round poles).

Grouted

When a base plate does not have grout under the base plate, the bolts will be assumed to take all compression and tension loads directly. When the grout space exceeds the height of a heavy hex nut and one anchor bolt diameter, then bending stress in the bolts will also be included (AASHTO procedure). Grouted base plates are analyzed using the procedure contained in common pressure vessel handbooks.

Anchor Bolt Grade

Enter the grade for the anchor bolts.

Anchor Bolt Size

Enter the nominal diameter for the anchor bolts.

Number of Bolts

Enter the number of bolts. This number may be limited by the standard spacing limitations for bolts (3 diameters). Square base plates will have the bolts clustered into four groups separated by the standard bolt spacing for the given bolt diameter.

Embedment Length

Enter the embedment length. This value is currently not used but will eventually be used in calculating pull out strength and development to pier reinforcing bars.

28 Day Strength, f'c

Enter the grout strength (if grouted) or the concrete strength (not grouted and with a grout space of 0). This will determine the allowable bearing pressure (.7f'c).

Grout Space

Enter the distance from the bottom of the base plate to the pier surface.

Base Plate Grade

Enter the material grade for the base plate.

Bolt Circle Diameter

Enter the diameter around which the bolts will be spaced. Square base plates will have four or eight bolts placed in the corners of the plate. The bolt circle will be checked for minimum clearance to the shell.

<i>Outer Diameter/Width</i>	Enter the outside diameter for the base plate. This will be check for consistency with the bolt circle diameter.
<i>Inner Diameter/Width</i>	Enter the inner diameter. The value cannot be greater than 1/8” larger than the shell diameter.
<i>Clipped Corner</i>	Some square base plates have “clipped” corners to reduce the size of the base plate. Enter the dimension from the corner of the plate to the clipped corner.
<i>Base Plate Type</i>	Choose from either plain or stiffened. Stiffened base plate will have gussets. Base plate with anchor bolt chairs are rare and are not supported.
<i>Bolts Per Stiffener</i>	Enter either one (a stiffener between each bolt) or two (a stiffener every other bolt).
<i>Stiffener Thickness</i>	Enter the thickness of the stiffener.
<i>Stiffener Height</i>	Enter the height of the stiffener.

Cost Data

Tower Input											
Code	Options	Geometry	Advanced	Guy Data	Feed Lines	Discrete Loads	Dishes	User Loads	Antenna Pole	Feed Tower	Cost Data
Item	Material Grade	Material Cost Per Pound	Handling Cost Per Pound								
Solid Round	A36	0.5	\$0.50								
	A572-50	\$0.50	\$0.50								
Flat Bar	A36	\$0.50	\$0.50								
	A572-50	\$0.50	\$0.50								
Single Angle, 60 Angle, 60 Bent Plate Angle, Channel, Arbitrary Shape	A36	\$0.50	\$0.50								
	A572-50	\$0.50	\$0.50								
Double Angle, Quad Angle, Double Channel	A36	\$0.50	\$0.50								
	A572-50	\$0.50	\$0.50								
Pipe, Grouted Pipe	A36	\$0.50	\$0.50								
	A572-50	\$0.50	\$0.50								
Truss Leg	A36	\$0.50	\$0.50								
	A572-50	\$0.50	\$0.50								
Guy Cable	EHS	\$0.50	\$0.50								
	BSUHS	\$0.50	\$0.50								

Summary

tnxTower uses rudimentary cost data to calculate estimates of tower cost.

Monopole Reinforcement

Summary

Separate structural elements can be added to the monopole shaft to model shaft reinforcement. The program will generate a combined structural model of the pole and the reinforcement. The addition does not modify the cross-sectional properties of the shaft. Rather, it creates a 3D frame structure with the reinforcing elements supporting and stiffening the pole. The pole and the reinforcing are designed as separate elements.

The reinforcing is entered in segments defined by the **Height Above Base** and **Reinforcing Length** parameters. Each reinforcing segment comprises a number of members spaced equally around the pole. All members within a reinforcing section have the same start height (determined by the **Height Above Base** setting) and length, and are identical structural shapes. Reinforcing members, except for Double Angles and Double Equal Angles, are oriented with their strong axis perpendicular to the surface of the pole. Double Angles and Double Equal Angles have their weak axis oriented perpendicular to the surface of the pole.

The reinforcing is modeled as connected to the pole at discrete points. It is important that the input captures this characteristic as accurately as possible to ensure that the pole-reinforcing interaction is properly simulated. The program assumes that the reinforcing is connected to the pole at ends of each reinforcing segment only.

	Height Above Base (ft)	Reinforcing Length (ft)	Number of Elements	Element Offset (in)	Reinforcing Type	Reinforcing Size	Reinforcing Unbraced Length (ft)	Reinforcing Controlling K	Reinforcing Bolt Hole Dis. (in)	Reinforcing Bolts per Row	Reinforcing Shear Lag Factor U
1	0.000	4.000	8	2.000	Tube	TS4x4x.25	4.000	1	0.75	1	1
2	4.000	4.000	8	2.000	Tube	TS4x4x.25	4.000	1	0.75	1	1
3	8.000	4.000	8	2.000	Tube	TS4x4x.25	4.000	1	0.75	1	1
4	12.000	4.000	8	2.000	Tube	TS4x4x.25	4.000	1	0.75	1	1
5	16.000	4.000	8	2.000	Tube	TS4x4x.25	4.000	1	0.75	1	1
6	20.000	4.000	8	2.000	Tube	TS4x4x.25	4.000	1	0.75	1	1
7	24.000	4.000	8	2.000	Tube	TS4x4x.25	4.000	1	0.75	1	1
8	28.000	4.000	8	2.000	Tube	TS4x4x.25	4.000	1	0.75	1	1
9	32.000	4.000	8	2.000	Tube	TS4x4x.25	4.000	1	0.75	1	1
10											
11											
12											

Reinforcing Grade

Steel grade of the reinforcement.

Height Above Base

Enter the height of lower end of each element above the base of the tower. The values in this column need to coincide with positions of points at which the reinforcing is attached to the pole. If the first reinforcing member starts at height 0.0, it is assumed that the member's end rests on the foundation (pinned support), and support reactions for that member will be calculated by the program.

Reinforcing Length

Enter the length of the element. It is assumed that the reinforcing elements are connected to the pole at their ends only.

<i>Number of Elements</i>	Reinforcing elements are spaced around the pole at constant intervals. Enter the number of elements that should be generated for the current reinforcing segment.
<i>Element Offset</i>	Enter the distance of the longitudinal axis of the element from the surface of the pole.
<i>Reinforcing Type</i>	Select the member type. The supported types are: Solid Round, Flat Bar, Pipe, Tube, Double Angle, Double Equal Angle, Channel, Wide Flange, and Arbitrary Shape.
<i>Reinforcing Size</i>	Select the member size. The sizes available are those that have been entered in the Structural Components database. If a required size is not available in the pull-down list, it needs to be added to the database via the normal database management facility.
<i>Reinforcing Unbraced Length</i>	If the reinforcing members have intermediate restraints against buckling, you may enter the unbraced length in this column. This value has no impact on the spacing of the connectors to the pole (see Reinforcing Length above).
<i>Reinforcing Controlling K</i>	If there are additional buckling restraints present, enter the controlling effective length factor K.
<i>Reinforcing Bolt Hole Dia.</i>	If the reinforcing elements are attached by bolts, enter the bolt hole diameter. This information is used for the calculation of net element area for tensile capacity checks.
<i>Reinforcing Bolts per Row</i>	For reinforcing elements attached by bolts, enter the number of bolts per row. This information is used for the calculation of net element area for tensile capacity checks.
<i>Reinforcing Shear Lag Factor U</i>	Enter the shear lag reduction factor value.

Candelabra Data

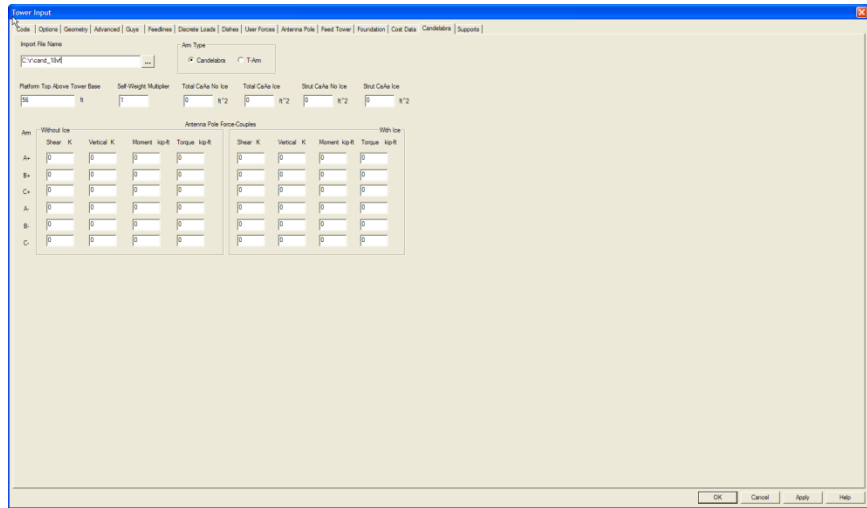

Summary

Refer to Candelabra Editing and Import chapter elsewhere in this Manual for more information on this feature as well as detailed instructions on candelabra input file creation.

Import File Name

Enter the name and full path of the candelabra file. You may navigate to the location of the file by clicking  beside the file name field.

Arm Type

Available choices are 3-sided candelabra and 1-sided T-arm.

Platform Top Above Tower Base

Determines the attachment height of the candelabra. Enter the distance between the tower base and the top of the candelabra platform.

Self-Weight Multiplier

This factor will be multiplied times the self-weight of the structural members to determine the section weight. This factor is supplied to take into account the weight of gusset plates not entered as gusset area, ladders, galvanizing, etc.

Total CaAa No Ice

Enter the aggregate value of projected areas of all components of the candelabra, excluding struts, for no ice conditions. tnxTower will generate appropriate wind loads based on that total CaAa value, in the direction of the wind, and apply them as uniformly distributed to all structural members, excluding struts.

The projected area of the candelabra is assumed constant for all wind directions.

Total CaAa Ice

As above, for ice conditions.

Strut CaAa No Ice

Enter the aggregate value of projected areas of all candelabra struts, for no ice conditions. tnxTower will generate appropriate wind loads based on that total

CaAa value, in the direction of the wind, and apply them as uniformly distributed to all struts.

The projected area of the struts is assumed constant for all wind directions.

Strut CaAa Ice

As above, for ice conditions.

Antenna Pole Forces

Enter antenna reactions at candelabra mounting points as concentrated forces and moments. The direction of the forces and the plane of the moments (except for Vertical and Torque) are set automatically by the program based on the wind direction. A, B, and C labels designate individual arms, (+) and (-) indicate the top and the bottom of the candelabra, respectively. The values need to be entered separately for No Ice and Ice conditions.

Equipment Load Cases

Summary

tnxTower allows to create groups of appurtenances using their Statuses (described by the **Classification Categories**) as the selection criteria. Each group establishes a separate **Load Case**. The analysis and design may be run automatically for all defined **Load Cases**.

Equipment Classification Categories (ECCs)

The ECCs are assigned for each equipment item on the **Feedlines, Discrete Loads, and Dishes** pages, in the **Classification Category** column. The following Categories are available by default: <unassigned>, Existing, Proposed, Reserved. The Categories can be amended by modifying the *tnxtower.ini* file located in the program installation folder.

Equipment Load Cases (ELCs)

Individual ELCs are put together on the **Load Cases** page of the **Tower Input** screen:

	Use	Load Case	Status 1	Status 2	Status 3	Status 4	Status 5	Status 6	Status 7
1	<input checked="" type="checkbox"/>	Load Case 1	Existing	Proposed	Reserved				
2	<input checked="" type="checkbox"/>	Load Case 2	Existing	Proposed					
3	<input checked="" type="checkbox"/>	Load Case 3	Existing	Reserved					
4	<input type="checkbox"/>								
5	<input type="checkbox"/>								
6	<input type="checkbox"/>								
7	<input type="checkbox"/>								
8	<input type="checkbox"/>								
9	<input type="checkbox"/>								
10	<input type="checkbox"/>								
11	<input type="checkbox"/>								
12	<input type="checkbox"/>								
13	<input type="checkbox"/>								
14	<input type="checkbox"/>								
15	<input type="checkbox"/>								
16	<input type="checkbox"/>								
17	<input type="checkbox"/>								
18	<input type="checkbox"/>								
19	<input type="checkbox"/>								
20	<input type="checkbox"/>								

Each ELC includes a number of equipment Statuses. The Statuses are limited to the available ECCs. The Status selection may be done directly for each ELC, or default values may be used to populate the table. The **Default Load Cases** buttons allow to define, edit, or insert default ELCs into the **Load Cases** table.

In the *Use* column you may select which ELCs will be used for the analysis and design runs. If no ELCs are entered on the **Load Cases** page, or if none of the ELCs is selected in the *Use* column, the program will not run in the ELC mode, and all equipment will be considered present, regardless of its **Classification Category**.

ELCs entered for a given model are saved with the balance of the tower information in the model file (.eri).

Default Load Cases

You can define a set of default ELCs for use on different projects. The default ELCs are stored on the PC on which they were defined. They are not saved in the model files.

	Load Case	Status 1	Status 2	Status 3	Status 4	Status 5	Status 6	Status 7
1	Load Case 1	Existing	Proposed	Reserved				
2	Load Case 2	Existing	Proposed					
3	Load Case 3	Existing	Reserved					
4								
5								
6								
7								
8								
9								
10								
11								
12								
13								
14								
15								
16								
17								
18								
19								
20								

In addition, there is an option of resetting the GUI-defined default ELCs to ELCs that are stored in the *tnxtower.ini* file. The following default ELCs are defined in the *tnxtower.ini* when the program is first installed:

Load Case 1: Existing, Proposed, Reserved
Load Case 2: Existing, Proposed
Load Case 3: Existing, Reserved

These default ELCs can be changed or additional ones can be appended by manually modifying the *tnxtower.ini* file.

If at any time you need to revert to the set of the *tnxtower.ini* ELCs, you will need to delete all of the rows in the **Define/Edit Default Load Cases** table. When the table is brought up again, it will be populated with the *tnxtower.ini* ELCs.

Equipment Load Case Analysis

Once the ELCs are defined and at least one is selected for use, tnxTower will run in the ELC mode. In this mode the program will automatically repeat the analysis and design cycles for all ELCs selected on the *Load Cases* page. The *Analysis and Design Report*, as well as the *CCI Report* will be produced for only one ELC, however. That ELC is selected on the screen shown below, which appears when the *Solve* command is invoked.

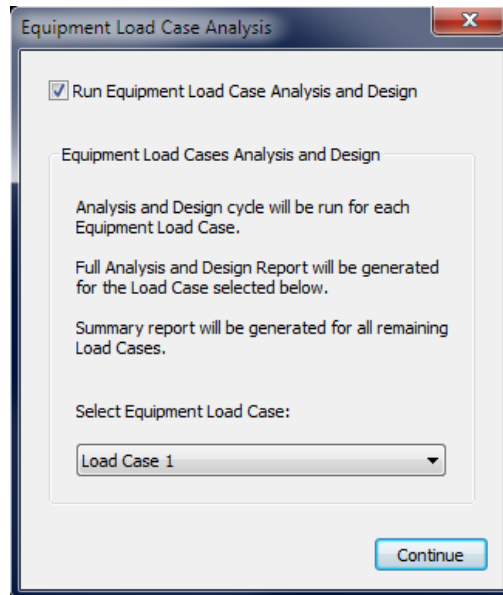

For the remaining ELCs a summary report is generated.

Data Storage Tags

Summary

The tnxTower input file (.eri) can be used for storing arbitrary, external text data. This external data would normally be related to the model data, but the program does not enforce any specific relationship. It is up to the user to determine what information should be stored in that section of the input file. The data is stored in a section of the input file, between user-defined tags. The tags may facilitate the retrieval of that data by manual or programmatic methods.

Note: Tower Numerics does not guarantee that the external data entered in the input file will be preserved without errors or at all, and the user assumes the risk of the loss of the data.

Data Tags Management

The user can define/delete arbitrarily named tags for use in the input file by selecting **Edit | Manage Data Tags ...** from the top menu.

Once tags are defined, they will be automatically appended to the .eri input file.

The user can insert any text data in the .eri file between matching tags. The opening tag has this format:

```
{.<user-defined tag name>}.}
```

and the closing tag this format:

```
{.~user-defined tag name~}.}
```

Only the **user-defined tag name** text is entered while defining a tag. The enclosing braces are automatically generated by the program.

When a file containing data tags is open, the user has an option of importing any tags that have not been defined already.

Data and tags are read in by the program and then included unmodified in the .eri file when the file is saved.

Tag names are stored in the Registry. Data and tags for tag names not previously defined (or imported) by the user will not be saved in the input file.

Command Line API

Summary

tnxTower allows to control the execution of the program via a simple command line API. This mode of operation of the program may be useful if automated or semi-automated analyses of different models are intended. The user may start the program with specific input files, suppress dialog and message boxes during the analysis run, request to generate the analysis and design report, and exit the program on completion of the run.

Setup In TNXTOWER.INI

The tnxtower.ini file, located in the program installation directory, must include the following elements to enable and define the API control mode:

```
<Enable API Mode>par</Enable API Mode>
```

par values: *No / Yes*

```
<API Run Show Window>par</API Run Show Window>
```

par values: *Hidden / Normal / Maximized / Minimized*

```
<Add Tags To Tag Definitions In API Run>par</Add Tags  
To Tag Definitions In API Run>
```

par values: *No / Yes / Ask*

API Commands Usage

All commands must be entered on a single command line, as follows:

```
START "" "installation path\tnxtower.exe" "input file  
path\model.eri" [par1 par2 par3 par4 par5 par6 par7]
```

Parameters par1, par2, etc. in [] brackets are optional. The parameters should be separated by spaces and can be entered in any order. Please see the table below for definitions of the parameters.

On the command line, the “ characters are required, as shown. The [] bracket characters should not be entered.

Parameter Table

Parameter (par1, par2, etc.)	Automated action
<i>RunAnalysis</i>	Starts the analysis
<i>SilentAnalysisRun</i>	Hides the results overwrite warning. Hides Tower Solution Options (e.g., Maximum number of cycles)
<i>GenerateDesignReport</i>	Generates the standard Analysis and Design Report
<i>OpenDesignReport</i>	Opens the standard Analysis and Design Report if <i>GenerateDesignReport</i> is also specified.
<i>SaveInputFileOnCompletion</i>	Saves the model input file after the Report is generated
<i>ExitOnCompletion</i>	Terminates the program once all actions are completed
<i>ShowCommandSummaryMsgBox</i>	Displays parameters (par1 ...) entered for the analysis run (diagnostics only)

Example

To generate and open the analysis and design report for the example **Falcon120.eri** file, the following should be entered on the command line:

```
START "" "C:\Program Files (x86)\TNX\  
tnxTower n.n.n\tnxtower.exe"  
"C:\Users\Public\Documents\tnxTower  
Files\Examples\Falcon120.eri" RunAnalysis  
SilentAnalysisRun GenerateDesignReport  
OpenDesignReport
```

Viewing Reports

Report Options

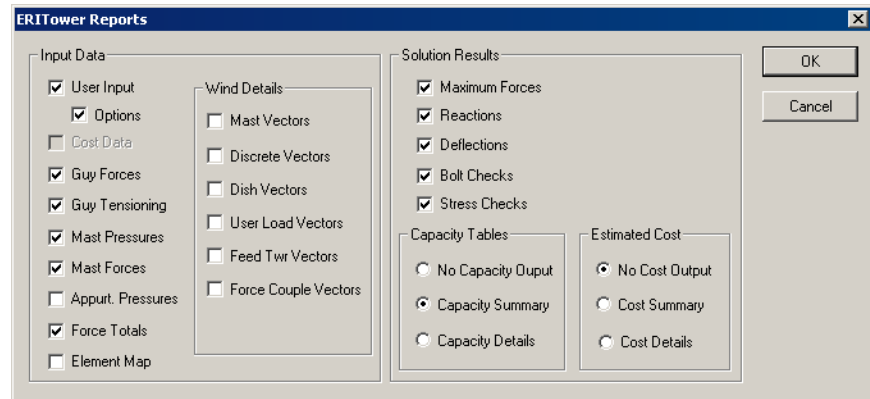

tnxTower uses Microsoft .RTF (Rich Text Format) files for all reports. When you have Microsoft Word installed on your system, you may view reports directly by choosing the Use MS Word in the Settings dialog. See Display and Printing Settings. When you do not have MS Word, you must use the Microsoft Word Viewer (information available here:

<http://support.microsoft.com/kb/891090>).

Input Data

User Input

Options

This option echoes tower geometry and load data as entered by the user.

This option will print a table showing the user defined options that were enabled for this analysis.

Guy Forces

This option echoes the guy forces that were calculated by tnxTower. This table can be used to determine if the guy tensions as input are in equilibrium or if there is an imbalance.

Guy Tensioning

This option echoes the guy tensioning table that will output initial tensions at various stressing temperatures.

Mast Pressures

This option prints out a table of mast data such as round and flat areas, gross area, and wind pressures for each section of the tower.

Mast Forces

This option prints out a table of mast data such as the total force by directionality for each section of the tower. An equivalent uniform load is also printed.

Appurtenance Pressures

This option prints out a table of appurtenance data and the pressures for each section of the tower.

Force Totals

This option prints out a table showing a summary of the calculated forces on the tower. Since these forces are calculated prior to an actual analysis, they give an independent check of the force totals that will be printed in the reaction summary.

Element Map

This options will print out the actual underlying element numbers per section that are used in the CHRONOS FEA analysis engine.

Wind Details

Should you need to determine how tnxTower has determined the forces on various components of the tower then you should check these boxes. Note that the output will be for all directions of wind that have been chosen and can therefore be quite extensive. It is recommended that these options only be used when necessary.

Solution Results

- **Maximum Forces.** Maximum component forces are listed section by section.
- **Reactions.** Tower foundations are listed.
- **Deflections.** Tower sway, tilt, twist and radius of curvature are listed.
- **Stress Checks.** Results of the stress analysis are listed.

Capacity Tables

Three options are available for viewing capacity data:

- **No Capacity Output.** No data is printed.
- **Capacity Summary.** Only a summary of the tower capacities is printed.
- **Capacity Details.** A detailed report is generated for tower capacities.

Estimated Cost Data

Three options are available for viewing cost data:

- **No Cost Output.** No data is printed.
- **Cost Summary.** Only a summary of the tower cost is printed.
- **Cost Details.** A detailed report is generated for tower costs.

Running the Solution

Summary

Self-Supporting Towers

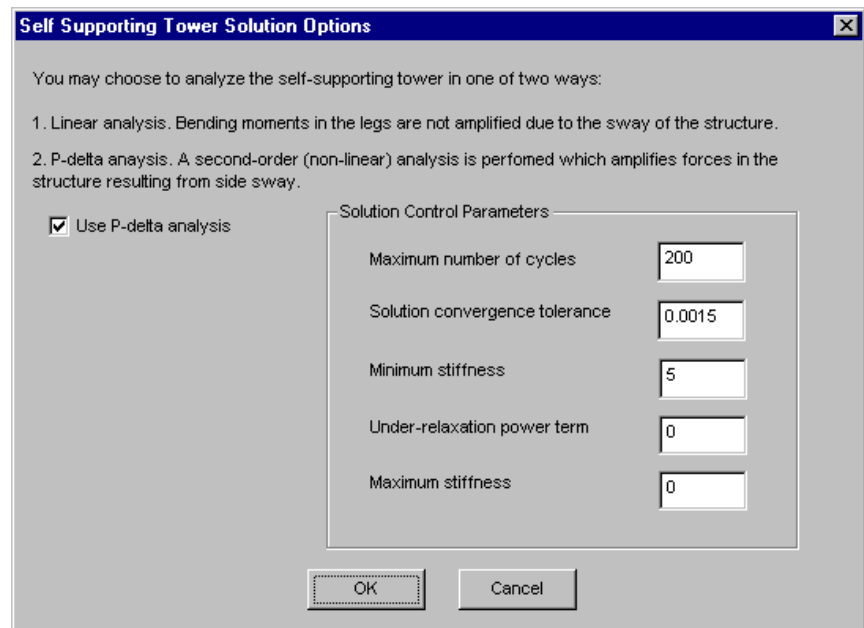

Analyzing and designing self-supporting towers may be accomplished with either a linear or non-linear (P-delta) analysis. Monopoles, slender towers, towers that contain tension-only bracing, and towers that contain feed towers, must perform a P-delta analysis.

Use P-delta Analysis

Check this option if you want to run a non-linear analysis. Self-supporting towers that have a height to base width ratio of 15 or greater should use a p-delta analysis. Monopoles always will use p-delta analysis.

Solution Control Parameters

These parameters are used for performing P-delta analysis runs. Some common guidance is provided later in this manual. See [Solution Parameters](#) in the Technical Appendix.

The solution convergence tolerance controls how accurate the final solution will be. Typically, a value of .001 will yield good results for monopoles and normal self-supporting towers. A value of .00015 may be needed for towers with tension-only systems. The program will usually take twice as long to solve for a tolerance of .00015 as it would for a tolerance of .001.

The minimum stiffness, power term and maximum stiffness need some explanation. For self-supporting towers, these parameters seldom need to be used and usually can be left blank. For very flexible towers that will not converge, these parameters can be entered. A general discussion of non-linear analysis can be found in the Appendix. See Non-Linear Analysis.

Guyed Towers

Solution Control Parameters	
Maximum number of cycles	500
Solution convergence tolerance	0.0004
Minimum stiffness	20
Under-relaxation power term	2
Maximum stiffness	3000

Guyed towers always use P-delta analysis due to the non-linear behavior of cable structures.

Solution Control Parameters

These parameters are used for performing P-delta analysis runs. Some common guidance is provided later in this manual. See [Solution Parameters](#) in the Technical Appendix.

The solution convergence tolerance controls how accurate the final solution will be. For preliminary designs, a value of .0005 could be used, while for final designs .00015-.0003 should be used.

The minimum stiffness, power term and maximum stiffness need some explanation. For guyed towers, these parameters usually need to be used. A general discussion of non-linear analysis can be found in the Appendix. See Non-Linear Analysis.

Editing Section Databases

Adding, Editing and Viewing Sections

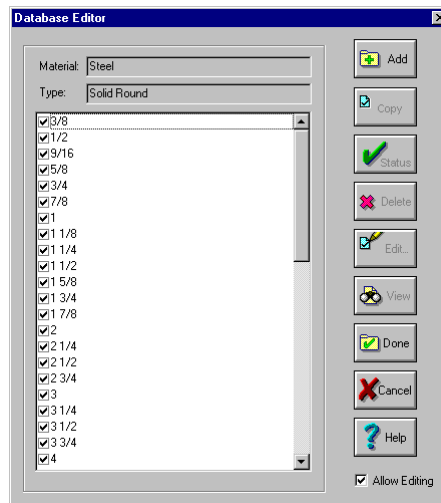

The database manager will enable the user to add sections, edit existing sections or disable sections as desired. The manager always backs up the database file to a file with a .bak extension. The database files are ASCII and are located in the DBASE/STEEL sub-directory. When you have made changes to the databases, then you should copy the database files to a backup sub-directory before installing an update to tnxTower. After installation of an update, then copy back your changed database files. This insures that the update will not overwrite any database files that you have changed.

Adding A Section Copying A Section

Click on the **Add** button and enter the data for the new shape.

Select one or more sections from the list box. Click on **Copy**. The program will ask for the new name under which to put the copy. This is useful if you are creating a section that is very close to an existing section.

Changing Status

Sections that are active are check marked. To disable sections from appearing in tnxTower, first select those section that are to be disabled, then click on **Status**. Reverse the process to re-enable the sections.

Deleting Sections

Select one or more sections from the list box. Click on **Delete**. Deleting sections is a permanent process and cannot be undone unless you click on **Cancel**.

Editing Sections

Viewing Sections

Allow Editing

Select one or more sections from the list box. Click on **Edit**. Editing sections is a permanent process and cannot be undone unless you click on **Cancel**.

Select one or more sections from the list box. Click on **View**.

You can flag a database as non-editable by un-checking the Allow Editing checkbox. The only functionality that this provides is that the Edit button will be unavailable.

Steel Shapes

Arbitrary Sections

Dimensions	
US Name	MySection 1400
SI Name	MySection 1400
Height	10 in
Width	35 in
Wind Proj.	10 in
Perimeter	30 in
Modulus	1400 ksi

Properties					
Area	1000 in ²	QaQs	0.9	Cw	0 in ⁶
Ix	1000 in ⁴	Iy	1000 in ⁴	J	30 in ⁴
Sx (top)	50 in ³	Sy (top)	50 in ³		
Sx (bot)	100 in ³	Sy (bot)	66.667 in ³		
rx	1 in	ry	1 in	<input checked="" type="checkbox"/> Treat as a round object for wind	
SFy	0	SFx	0		

You must enter values for Area, Ix, Iy and J. Cw (warping constant) may be left blank if warping is not to be considered. SFy and SFx (shear deflection form factors = Area/Shear Area) may be left if shear deflection is to be neglected. QaQs is a stress reduction factor. Allowable stresses will be a maximum of $.60 \times F_y \times QaQs$ in bending and axial. Allowable shear will be $.4 \times F_y$ over $2/3$ of the area. A modulus of elasticity may be specified to accommodate composite shapes such as concrete-filled pipe. Note that if an arbitrary shape is used as a leg member, the local Y-axis will be oriented radiating from the centroid of the tower.

Solid Round Sections

Dimensions	
US Name	1
SI Name	25
Diameter	1 in

Properties	
Area	0.785 in ²
Ix	0.049 in ⁴
Sx	0.098 in ³
Zx	0.167 in ³
J	0.098 in ⁴
SF	1.111

Flat Bar Section

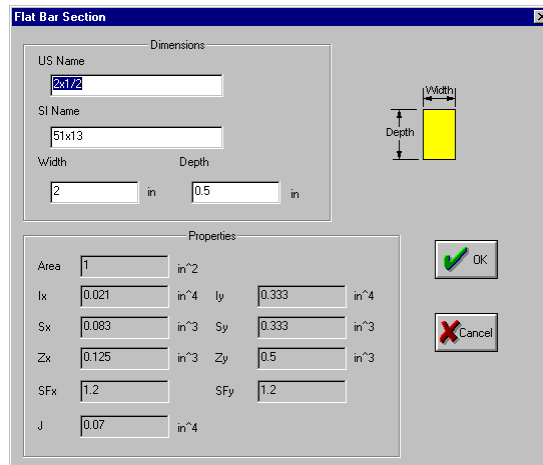

The Flat Bar Section dialog box is divided into two main sections: Dimensions and Properties. The Dimensions section includes fields for US Name (2x1/2), SI Name (51x13), Width (2 in), and Depth (0.5 in). A diagram shows a yellow rectangle representing the flat bar with arrows indicating Width and Depth. The Properties section includes fields for Area (1 in²), Ix (0.021 in⁴), Iy (0.333 in⁴), Sx (0.083 in³), Sy (0.333 in³), Zx (0.125 in³), Zy (0.5 in³), SFx (1.2), SFy (1.2), and J (0.07 in⁴). There are OK and Cancel buttons on the right.

Dimensions	
US Name	2x1/2
SI Name	51x13
Width	2 in
Depth	0.5 in

Properties	
Area	1 in ²
Ix	0.021 in ⁴
Iy	0.333 in ⁴
Sx	0.083 in ³
Sy	0.333 in ³
Zx	0.125 in ³
Zy	0.5 in ³
SFx	1.2
SFy	1.2
J	0.07 in ⁴

Pipe

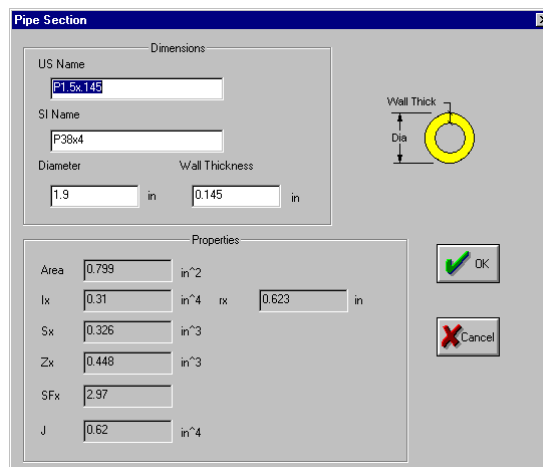

The Pipe Section dialog box is divided into two main sections: Dimensions and Properties. The Dimensions section includes fields for US Name (P1.5x1.45), SI Name (P38x4), Diameter (1.9 in), and Wall Thickness (0.145 in). A diagram shows a yellow circle representing the pipe with arrows indicating Wall Thickness and Dia. The Properties section includes fields for Area (0.799 in²), Ix (0.31 in⁴), Iy (0.623 in⁴), Sx (0.326 in³), Sy (0.623 in³), Zx (0.448 in³), Zy (0.623 in³), SFx (2.97), SFy (2.97), and J (0.62 in⁴). There are OK and Cancel buttons on the right.

Dimensions	
US Name	P1.5x1.45
SI Name	P38x4
Diameter	1.9 in
Wall Thickness	0.145 in

Properties	
Area	0.799 in ²
Ix	0.31 in ⁴
Iy	0.623 in ⁴
Sx	0.326 in ³
Sy	0.623 in ³
Zx	0.448 in ³
Zy	0.623 in ³
SFx	2.97
SFy	2.97
J	0.62 in ⁴

TIA-222-H only: Pipe shapes whose name include the <ERW> tag (e.g., **P4.5x0.337<ERW>**), will be treated as ERW shapes in compression, tension, and bending strength calculations (see sections 4.5.4.2, 4.6.3, and 4.7 of TIA-222-H).

Tubes

Tube

Dimensions

US Name:

SI Name:

Depth: in

Width: in

Thickness: in

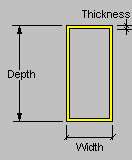

OK
Cancel
Help

Properties

Area	<input type="text" value="3.59"/>	in ²	J	<input type="text" value="13.5"/>	in ⁴
Ix	<input type="text" value="8.22"/>	in ⁴	Iy	<input type="text" value="8.22"/>	in ⁴
Sx	<input type="text" value="4.11"/>	in ³	Sy	<input type="text" value="4.11"/>	in ³
rx	<input type="text" value="1.51"/>	in	ry	<input type="text" value="1.51"/>	in
Zx	<input type="text" value="4.97"/>	in ³	Zy	<input type="text" value="4.97"/>	in ³
SFx	<input type="text" value="1.795"/>		SFy	<input type="text" value="1.795"/>	

Single Angle

Single Angle Section

Dimensions

US Name:

SI Name:

Height: in

Width: in

Thickness: in

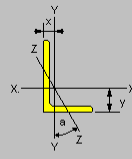

OK
Cancel

Properties

Area	<input type="text" value="0.715"/>	in ²	Ix	<input type="text" value="0.272"/>	in ⁴	Iy	<input type="text" value="0.272"/>	in ⁴
tan a	<input type="text" value="1"/>		ly	<input type="text" value="0.568"/>	in	x	<input type="text" value="0.568"/>	in
rz	<input type="text" value="0.394"/>	in	y	<input type="text" value="0.19"/>	in ³	Sy (tip)	<input type="text" value="0.19"/>	in ³
J	<input type="text" value="0.0088"/>	in ⁴	Sx (top)	<input type="text" value="0.617"/>	in	ry	<input type="text" value="0.617"/>	in
Cw	<input type="text" value="0.00254"/>	in ⁶	rx	<input type="text" value="0.343"/>	in ³	Zy	<input type="text" value="0.343"/>	in ³
ro	<input type="text" value="1.1"/>	in	Zx	<input type="text" value="1.46047"/>		SFy	<input type="text" value="2.9701"/>	
H	<input type="text" value="0.628"/>		SFx	<input type="text" value="1.46047"/>		SFy	<input type="text" value="2.9701"/>	

Double Angle

Double Angle Section

Dimensions

US Name:

SI Name:

Leg Height: in

Leg Width: in

Thickness: in

Back to Back: in

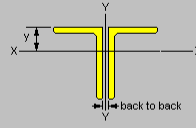

OK
Cancel

Properties

Area	<input type="text" value="1.88"/>	in ²	Ix	<input type="text" value="0.69"/>	in ⁴	Iy	<input type="text" value="1.34982145075455"/>	in ⁴
rz	<input type="text" value="0.391"/>	in	y	<input type="text" value="0.603"/>	in	Sy	<input type="text" value="0.674910725377274"/>	in ³
J	<input type="text" value="0.0390625"/>	in ⁴	Sx (bot)	<input type="text" value="0.494"/>	in ³	Sy	<input type="text" value="0.674910725377274"/>	in ³
Cw	<input type="text" value="0.011444091796875"/>	in ⁶	rx	<input type="text" value="0.609"/>	in	ry	<input type="text" value="0.849"/>	in
ro	<input type="text" value="1.15"/>	in	Zx	<input type="text" value="0.89"/>	in ³	Zy	<input type="text" value="0"/>	in ³
H	<input type="text" value="0.834"/>		SFx	<input type="text" value="1.46047"/>		SFy	<input type="text" value="2.9701"/>	

Quad Angle

Dimensions		Properties	
US Name	4L2x2x5/16	Area	4.6 in ²
SI Name	4L51x51x8	Ix	3.40928 in ⁴
Leg Height	2 in	Iy	3.40928 in ⁴
Leg Width	2 in	ra	0.601 in
Thickness	0.3125 in	J	0.150044759114583 in ⁴
Back to Back	0 in	Cw	0.0425053553448783 in ⁶
		Sx	1.70464 in ³
		Sy	1.70464 in ³
		rx	0.860899 in
		ry	0.860899 in
		Zx	2.83667 in ³
		Zy	2.83667 in ³
		SFx	1.46047
		SFy	1.46047

Schifflerized Angle 60 Angle

Please refer to 60 Angle.

Also known as a **Schifflerized Angle**.

Dimensions		Properties	
US Name	V8x8x1/2	Area	7.75 in ²
SI Name	V203x203x13	Ix	44.5615378 in ⁴
Height	8 in	Iy	28.73220892 in ⁴
Thickness	0.5 in	J	0.64583333 in ⁴
		Cw	3.68262238 in ⁶
		ro	4.71621256 in
		H	0.4252
		Sx	10.5274873 in ³
		Sy(tip)	9.06280851 in ³
		Sy(heel)	8.02848752 in ³
		rx	2.39788987 in
		ry	1.92545626 in
		xbar	4.2329 in
		ybar	3.5788 in

60 Degree Bent Plate

Dimensions		Properties	
US Name	09-27SS (12x5)	Area	6 in ²
SI Name	09-27SS (12x5)	Ix	26.70750527 in ⁴
Length of Plate	12 in	Iy	12.70572198 in ⁴
Thickness	0.5 in	rx	2.10979877665052 in
Inside Bend Radius	1 in	Sx	7.32808748 in ³
		Sy(tip)	4.72051322 in ³
		Sy(heel)	5.36896071 in ³
		xbar	2.3709 in
		ry	1.45520456619702 in

Channel

Channel Section

Dimensions

US Name:

SI Name:

Depth: in

Width: in

Web: in

Flange: in

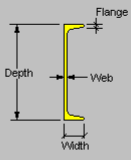

Properties

Area	<input type="text" value="2.64"/> in ²	xp	<input type="text" value="0.262"/> in	fillet radius	<input type="text" value="0.29"/> in
k	<input type="text" value="0.75"/> in	eo	<input type="text" value="0.427"/> in	x	<input type="text" value="0.478"/> in
d/AI	<input type="text" value="8.29"/> 1/in	lx	<input type="text" value="8.9"/> in ⁴	ly	<input type="text" value="0.632"/> in ⁴
J	<input type="text" value="0.11"/> in ⁴	Sx	<input type="text" value="3.56"/> in ³	Sy (tip)	<input type="text" value="0.45"/> in ³
Cw	<input type="text" value="2.93"/> in ⁶	rx	<input type="text" value="1.83"/> in	ry	<input type="text" value="0.489"/> in
ro	<input type="text" value="2.1"/> in	Zx	<input type="text" value="4.36"/> in ³	Zy	<input type="text" value="0.918"/> in ³
H	<input type="text" value="0.814"/>	SFx	<input type="text" value="1.62462"/>	SFy	<input type="text" value="2.18833"/>

OK Cancel

Double Channel

Double Channel Section

Dimensions

US Name:

SI Name:

Depth: in

Width: in

Web: in

Flange: in

Back to Back: in

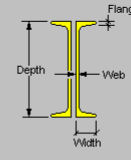

Properties

Area	<input type="text" value="2.94"/> in ²	fillet radius	<input type="text" value="0.27"/> in		
k	<input type="text" value="0.6875"/> in	eo	<input type="text" value="0.392"/> in	x	<input type="text" value="0.438"/> in
ra	<input type="text" value="0.319659214798263"/> in	lx	<input type="text" value="3.7"/> in ⁴	ly	<input type="text" value="1.46562"/> in ⁴
J	<input type="text" value="0.08"/> in ⁴	Sx	<input type="text" value="2.48"/> in ³	Sy	<input type="text" value="3.34616438356164"/> in ³
Cw	<input type="text" value="0.76"/> in ⁶	rx	<input type="text" value="1.12"/> in	ry	<input type="text" value="0.706054"/> in
ro	<input type="text" value="1.45"/> in	Zx	<input type="text" value="3"/> in ³	Zy	<input type="text" value="1.19511"/> in ³
H	<input type="text" value="0.674"/>	SFx	<input type="text" value="1.89922"/>	SFy	<input type="text" value="1.79727"/>

OK Cancel Help

Wide Flange

Wide Flange Section

US Name: SI Name: Depth Series:

Dimensions:

Depth: in
 Flange Width: in
 Web: in
 Flange Thick: in

Properties:

Area	<input type="text" value="5.26"/> in ²	h/tw	<input type="text" value="29.9"/>	fillet radius	<input type="text" value="0.3"/> in
k	<input type="text" value="0.75"/> in	d/tw	<input type="text" value="35.4"/>	bf/2tf	<input type="text" value="8"/>
d/Af	<input type="text" value="4.7"/> 1/in	Ix	<input type="text" value="61.9"/> in ⁴	Iy	<input type="text" value="7.97"/> in ⁴
J	<input type="text" value="0.17"/> in ⁴	Sx	<input type="text" value="15.2"/> in ³	Sy	<input type="text" value="3.04"/> in ³
Cw	<input type="text" value="122"/> in ⁶	rx	<input type="text" value="3.43"/>	ry	<input type="text" value="1.23"/> in
rt	<input type="text" value="1.39"/> in	Zx	<input type="text" value="17"/> in ³	Zy	<input type="text" value="4.66"/> in ³
		SFx	<input type="text" value="2.80953"/>	SFy	<input type="text" value="1.51804"/>
X1	<input type="text" value="2490000"/>	Qf	<input type="text" value="3.31"/> in ³	Sw	<input type="text" value="4.44"/> in ⁴
X2	<input type="text" value="3890"/>	Qw	<input type="text" value="8.52"/> in ³	Wno	<input type="text" value="10.3"/> in ²

Truss-Leg

Truss-Leg Section

US Name: SI Name:

Depth: in
 Section Length: ft
 K-Brace Dist: in
 Diag Spacing: in
 Num Full Bays:
 Num Horizontals:

Leg Size: in
 Inner Size: in
 Horizontal Size: in
 Top Girt Size: in
 Bot Girt Size: in

Bracing Type: Z X K-Right
 Leg Grade:
 Diagonal Grade:

Flat Plates:

	No Ice	1/2" Ice	1" Ice	2" Ice	4" Ice
Af (Face) in ²	<input type="text" value="204"/>	<input type="text" value="224"/>	<input type="text" value="244"/>	<input type="text" value="284"/>	<input type="text" value="364"/>
Af Weight K	<input type="text" value="0.0085069"/>	<input type="text" value="0"/>	<input type="text" value="0"/>	<input type="text" value="0"/>	<input type="text" value="0"/>
Conn CaAa in ²	<input type="text" value="399"/>	<input type="text" value="447.33333"/>	<input type="text" value="495.66666"/>	<input type="text" value="592.33333"/>	<input type="text" value="785.66666"/>
Conn Weight K	<input type="text" value="0.0865712"/>	<input type="text" value="0.1186275"/>	<input type="text" value="0.1506838"/>	<input type="text" value="0.2147965"/>	<input type="text" value="0.3430218"/>

Properties:

	w/o Ice	w/ 1/2" Ice
Area in ²	<input type="text" value="7.216"/>	<input type="text" value="13.282834"/>
Ix in ⁴	<input type="text" value="271.975"/>	<input type="text" value="3825.456188"/>
Iy in ⁴	<input type="text" value="271.975"/>	<input type="text" value="0.542982185"/>
Sx (top) in ³	<input type="text" value="28.523"/>	<input type="text" value="0.323474635"/>
Sy in ³	<input type="text" value="32.475"/>	<input type="text" value="0.8277899"/>
Sx (bot) in ³	<input type="text" value="52.251"/>	<input type="text" value="2542.403502"/>
J in ⁴	<input type="text" value="543.951"/>	<input type="text" value="0.323474635"/>
Der in	<input type="text" value="8.8277899"/>	<input type="text" value="13.282834"/>
Atot in ²	<input type="text" value="2542.403502"/>	<input type="text" value="3825.456188"/>
e	<input type="text" value="0.323474635"/>	<input type="text" value="0.542982185"/>

Truss-legs usually have a k-braced panel at each end of the section. This is known as the k-brace distance. The diagonal spacing is for the full bays (panels) in between the k-braced ends. The number of full bays is the number of z-braced or x-braced panels. Note that for K-brace right type of panels, the diagonal spacing is the distance that one diagonal spans vertically between the legs and therefore the number of bays is the number of diagonals. The inner size is the diameter of the diagonal members.

EHS Cable

Dimensions	
US Name	2/18
SI Name	11
Diameter	0.4375 in

Properties	
Area	0.1156 in ²
B.S.	20.8 K
Modulus	21000 ksi
Wt.	0.399 plf

B.S. is the breaking strength of the cable.

BS Cable

Dimensions	
US Name	2/4
SI Name	19
Diameter	0.75 in

Properties	
Area	0.338 in ²
B.S.	68 K
Modulus	23500 ksi
Wt.	1.18 plf

B.S. is the breaking strength of the cable.

UHS Cable

Dimensions	
US Name	2.1/4"UHS
SI Name	57.15
Diameter	2.25 in

Properties	
Area	3.04 in ²
B.S.	706 K
Modulus	23500 ksi
Wt.	10.64 plf

B.S. is the breaking strength of the cable.

Synchronizing Databases

The tnxTower databases are located in the following sub-directories located within the installation directory.

DBASE\	The root directory for the databases	
STEEL\	Main sub-directory for steel section databases	
	ARSPACE.ARC	Arbitrary shapes
	ANGLE.ARC	Single angle shapes
	EQANGLE.ARC	Equal leg single angle shapes
	BPL60.ARC	60 degree bent plate shapes
	CABLEBS.ARC	Bridge strand guy wires
	CABLEEHS.ARC	Extra Heavy Strength guy wires
	CABLEUHS.ARC	Ultra Heavy Strength guy wires
	CHANNEL.ARC	Channel shapes
	DBLANGLE.ARC	Double angle shapes
	EQDBLANGLE.ARC	Equal leg double angle shapes
	DBLCHANNEL.ARC	Double channel shapes
	FLATBAR.ARC	Bar shapes
	QDANGLE.ARC	Quad angle shapes
	SCHIF.ARF	60 angle (Schifflerized) shapes
	TRUSSLEG.ARC	Truss-leg shapes
	TUBE.ARC	Rectangular tube shapes
	WFLANGE.ARC	Wide flange shapes
	PIPE.ARC	Pipe shapes

MATL\ Main sub-directory for material databases

MEMBER\	Structural elements sub-directory
BOLT\	Bolts sub-directory

MISCL\ Main sub-directory for appurtenances, dishes, etc.

Each of the following sub-directories contains user-defined database files:

APPURT\	Appurtenance sub-directory
ASSEMBLY\	Tower assembly sub-directory
DISH\	Dish sub-directory
FEEDLINE\	Feed line sub-directory

The MASTER database directory is the current root directory for the DBASE system of directories. It is set in the File | Settings Database Files (Root Directory) dialog.

The REMOTE database is one or more directories that also contain a DBASE system of directories. They can reside on the same machine, on a different machine on a local area network (LAN) or a wide area network (WAN). The remote database(s) may contain changes that other offices or users have added or changed to the standard databases that are supplied with tnxTower. These commonly would be databases of dishes and appurtenances.

To synchronize the various databases, use the Database | Synchronize menu item. The following dialog will allow you enter the remote database root directories you wish to synchronize.

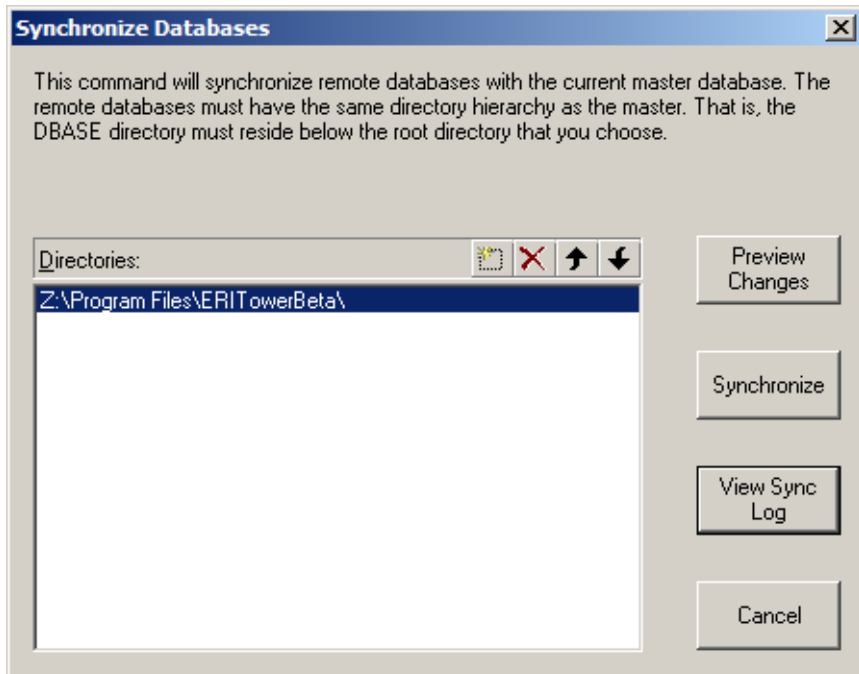

To enter data in the list box, you may type in the name of the directory, or choose the Add Directory toolbar button and click on the Browse button. Once you have added all of the directories you wish to synchronize, click the Synchronize button.

When you use the Preview Changes button, the program will create a report of what synchronization actions will be accomplished when the synchronization process is actually carried out. No changes to the databases are carried out during the Preview process.

When you use the Synchronize button, the synchronize process automatically creates backup copies of all files that will be changed. The backup file name contains a time and date stamp in the event that a database needs to be rolled back to a previous version.

All events during the synchronize process are records in a file names synclog.txt located in the tnxTower installation directory.

The synchronize action will process files in the following order.

1. Process each remote database to the master database. When the file does not exist on the master, it is copied. When the file does exist and is different from the master, then each section will be analyzed for additions or changes. When a section in a database has different values between the remote and master, then the program will ask you if you want to update the master file.
2. Once the master has been updated from all of the remote databases, then all of the database files will be copied to each remote database in turn.

A problem may arise when you synchronize multiple office databases and each has entered the same section with different values. For instance, each office may have created a database for a Decibel DBH44H antenna. Each may have given it the same name, but entered different values for CaAa or weight. When the section already exists in the "master" database, then tnxTower will first ask if you want to overwrite the master value with the remote value. When

overwriting, tnxTower processes the databases in the order you specified, the value that will govern during synchronization would be the values in the last database specified.

When you routinely receive tnxTower model files through e-mail from remote offices, then tnxTower automatically adds sections to your databases. When the section already exists, then the values contained within the model will not overwrite the values in the current database.

When you do not have a WAN link to your remote offices and you still want to synchronize your offices, have the remote office e-mail you a copy of their databases and copy them into the UPDATE\DATABASE system of directories that resides in the installation directory of tnxTower. Be certain the databases are in the correct sub-directories. Then start tnxTower. The UPDATE directory is a unique database set of files that will automatically be updated whenever you start tnxTower. The files update is one-way to the master only. The database files in the UPDATE directories are deleted after the auto-synchronization is complete. You can then copy your databases and return them via email to the remote office.

The View Sync Log button will bring up a report on the actions that were taken during the synchronization process. Note that whenever tnxTower opens an existing model file, the embedded steel shapes within the model file are automatically synchronized to the databases. This allows for portability should the model file be sent electronically. Any changes to the databases due to this process will also be noted in the sync log.

Editing Material Databases

Adding, Editing and Viewing Material Grades

The Editor may be accessed by selecting Database -> Materials from the top program menu.

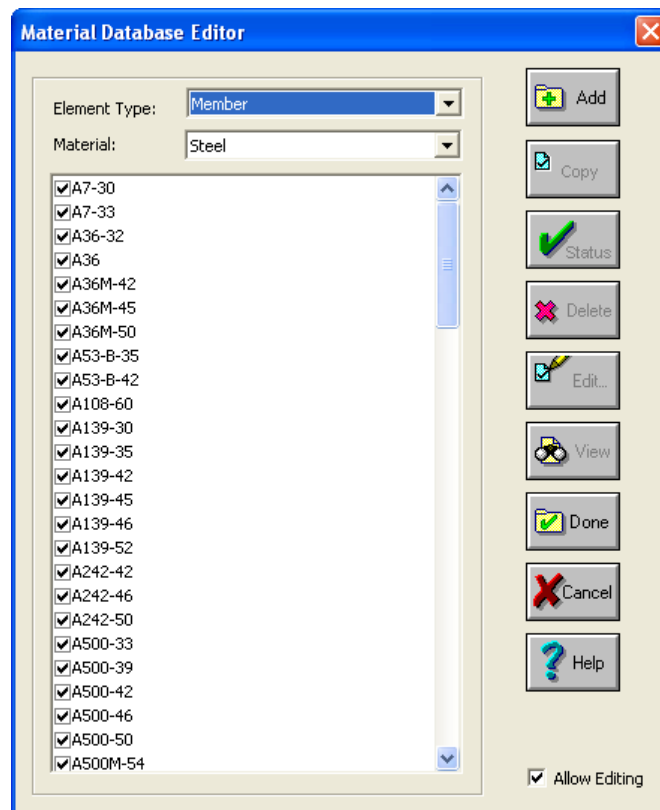

The following databases are available:

- Member Steel (default view)
- Member Custom
- Bolt Steel
- Bolt Custom

Member Steel and Bolt Steel databases include lists of standard grades that cannot be deleted or modified. However, users may add their own grades to both Steel and Custom databases. Those grades may be modified or deleted as needed.

To define a new material, click the Add button of the Editor to bring up the relevant dialog box, and enter material properties:

- Member



The Member Material Grade Editor dialog box is shown. It has a title bar with the text "Member Material Grade Editor" and a close button. The dialog contains the following fields:

Name:	<input type="text" value="New MemberGrade"/>
Fy:	<input type="text" value="50"/> ksi
Fu:	<input type="text" value="65"/> ksi
E:	<input type="text" value="29000"/> ksi
G:	<input type="text" value="29000"/> ksi
Thermal:	<input type="text" value="6.5e-006"/> /F
Density:	<input type="text" value="490"/> pcf

At the bottom of the dialog are "Cancel" and "OK" buttons.

- Bolt

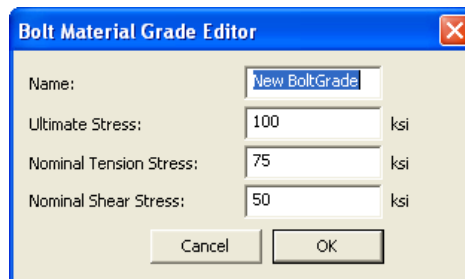

The Bolt Material Grade Editor dialog box is shown. It has a title bar with the text "Bolt Material Grade Editor" and a close button. The dialog contains the following fields:

Name:	<input type="text" value="New BoltGrade"/>
Ultimate Stress:	<input type="text" value="100"/> ksi
Nominal Tension Stress:	<input type="text" value="75"/> ksi
Nominal Shear Stress:	<input type="text" value="50"/> ksi

At the bottom of the dialog are "Cancel" and "OK" buttons.

The Ultimate Stress is the F_{ub} value for the bolt. The Nominal Tension Stress and Nominal Shear Stress correspond to the F_{nt} and F_{nv} values in Table J3.2 of the AISC Specification. However, they are only used for custom bolt grades, i.e., grades different than the following standard grades:

A307, A354BC, A354BD, A449, A325SC, A325N, A325X, SAEGR-5, A490SC, A490N, A490X, SAEGR-8, A572-42, A572-50B, A572-55, A572-60, A572-65B, A615, A615M, A615-75, F1554-36, F1554-55, and F1554-105.

For custom bolt grades, the Nominal Tension Stress or Nominal Shear Stress is multiplied by the bolt area and the appropriate resistance factor to obtain the design tension or shear strength.

TIA-222-H:

Bolt tension and shear strength calculations are based on the Ultimate Stress value, as entered in the database, for both standard and custom bolt grades, in accordance with Section 4.9.6 of TIA-222-H. The program assumes that for the following standard grades the threads are included in the shear plane: A307, A325N, and A490N. Threads will be assumed excluded for any custom grade, unless the grade name includes the “-N” suffix, e.g., BGR12-N.

Please note that any user-defined materials (in either Steel or Custom categories) used in a model will not be available if the model is opened in tnxTower version 5.0 or earlier. The member and bolt material grades will be substituted by A36 and A325N, respectively, as the earlier versions of the program use a limited (built-in) set of materials.

Editing Component Databases

Adding, Editing and Viewing Sections

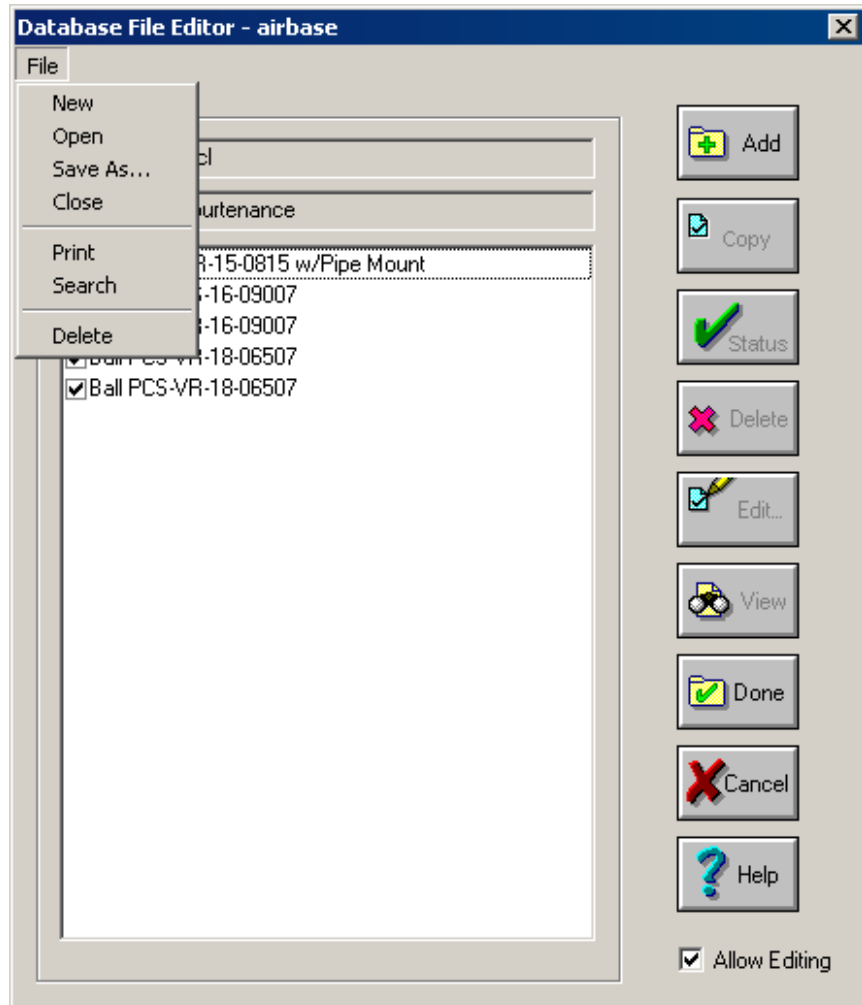

The database manager will enable the user to add sections, edit existing sections or disable sections as desired. The manager always backs up the database file to a file with a .bak extension. The database files are ASCII and are located in the DBASE/ sub-directory. You can add additional shapes to the databases that are supplied and they will be preserved when installing program updates. However, shapes that come standard with the program will be re-written to their original values during each update. Therefore, if you want to change a value for an original shape, you should use the “copy” feature and rename the shape. This will insure that the changed shape will remain after an update is performed.

The database manager will allow you to create and maintain multiple component database files using the File menu. This is convenient for grouping components such as feedlines and dishes by manufacturer's name. Options under the File menu are

- **New** Creates a new empty database with the temporary name of "unnamed". You must use the File Save As command to rename the file before saving it.
- **Open** Opens an existing database from a list. When only one database file exists then it is opened immediately.
- **File Save As** Saves the current database file under a different name.
- **Close** Closes and saves the current database file.
- **Print** Prints out a listing of all of the sections in the current database.
- **Search** Allows you to search for a name or part of a name when you are not sure which database might contain a certain shape.
- **Delete** Displays a list of databases from which you can choose which file to delete. You cannot delete a database that is currently open for editing.

Feed Line Shapes

	No Ice	1/2" Ice	1" Ice	2" Ice	4" Ice
Weight klf	0.00122	0.00292	0.0046199	0.0080199	0.0148199
CaAa ft ² /ft	0.1567	0.2419	0.3271	0.4975	0.8383

Dish Shapes

Dish Section

US Name

SI Name

Dish Type

- Paraboloid w/o Radome
- Paraboloid w/Radome
- Paraboloid w/Shroud (HP)
- Grid
- Conical Horn
- Passive Reflector

Outside Diameter ft



OK Cancel Help

	No Ice	1/2" Ice	1" Ice	2" Ice	4" Ice
Weight K	<input type="text" value="0.317"/>	<input type="text" value="0.784"/>	<input type="text" value="1.251"/>	<input type="text" value="2.185"/>	<input type="text" value="4.053"/>
Aperture Area ft ²	<input type="text" value="78.54"/>	<input type="text" value="79.854"/>	<input type="text" value="81.168"/>	<input type="text" value="83.796"/>	<input type="text" value="89.052"/>

Appurtenance Shapes

Appurtenance Section

US Name

SI Name

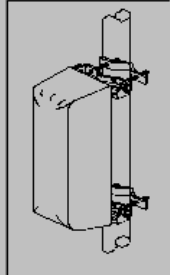

OK Cancel Help

Type

- Generic
- Flat Panel
- Triagonal (LPD)
- Cylindrical (Omni)

Height in
 Width in
 Depth in
 Weight K

Mount

- 2" Pipe
- 2 1/2" Pipe
- 3" Pipe
- 3 1/2" Pipe

Length in

	No Ice	1/2" Ice	1" Ice	2" Ice	4" Ice
Weight K	<input type="text" value="0.01"/>	<input type="text" value="0.01"/>	<input type="text" value="0.01"/>	<input type="text" value="0.01"/>	<input type="text" value="0.02"/>
CaAa (Front) ft ²	<input type="text" value="3.41"/>	<input type="text" value="3.87"/>	<input type="text" value="4.33"/>	<input type="text" value="5.25"/>	<input type="text" value="7.09"/>
CaAa (Side) ft ²	<input type="text" value="3.41"/>	<input type="text" value="3.87"/>	<input type="text" value="4.33"/>	<input type="text" value="5.25"/>	<input type="text" value="7.09"/>

The effective projected areas CaAa values displayed in the Appurtenance Section window are calculated at the time of the data entry, in accordance with the TIA/EIA-222-F Standard, and stored in the database files. However, for

projects under TIA-222-G and TIA-222-H the effective projected areas are recalculated at runtime, and the modified values are used in the loading definition.

Assemblies

Bracing Type	Has K-Brace End Panels	Has Horizontal
X Brace	No	Steps
Leg Grade	Leg Type	Leg Size
A572-50	Solid Round	2
Diagonal Grade	Diagonal Type	Diagonal Size
A36	Solid Round	9/16
Inner Bracing Grade	Inner Bracing Type	Inner Bracing Size
A572-50	Solid Round	
Top Girt Grade	Top Girt Type	Top Girt Size
A572-50	Solid Round	3/4
Bottom Girt Grade	Bottom Girt Type	Bottom Girt Size

Assemblies are pre-constructed tower sections. Creating libraries of standard tower sections will save considerable time when entering latticed pole and main tower sections when generating the geometry of the tower.

All of the data items correspond to items described in the Geometry Data and Advanced Data sections of this manual.

Geometry View

Summary

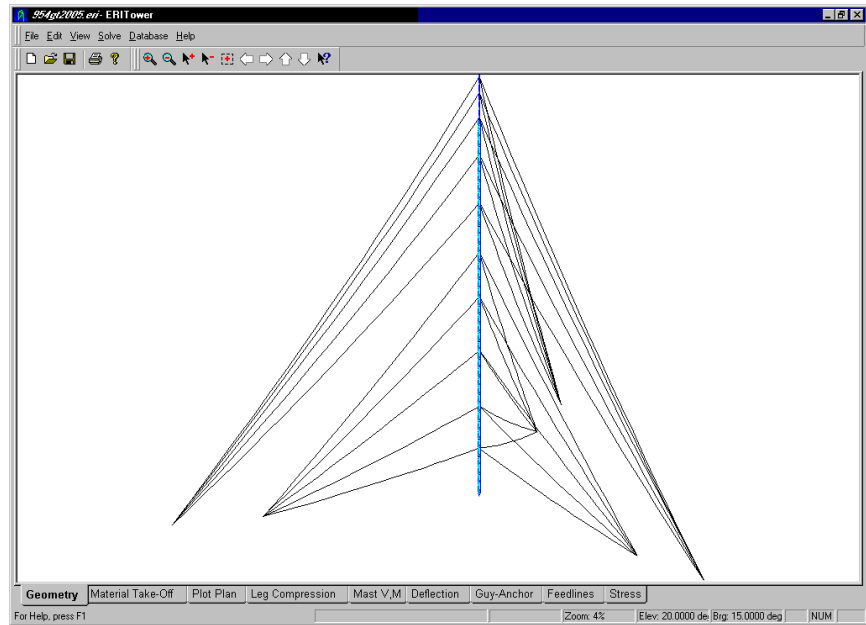

The Geometry View is the main view for determining if tnxTower has generated the tower properly. You will ordinarily want to zoom in to check framing styles and girt locations. To make a hardcopy of the view you can use the File|Print, File|Print Preview or the printer toolbar button.

Sending Plots To Clients Electronically

Any of the graphics views and reports within tnxTower may be printed to a file and sent electronically to other offices or clients. This can be accomplished with Adobe Acrobat PDF Writer or Adobe Distiller. Once either of these programs is installed, you can create a .PDF file by choosing the PDF Writer or Distiller as the current printer device. All of the screen graphics and reports will then be written to an Adobe PDF file. We suggest that the graphics be printed to an 11x17 landscape PDF file for ease of viewing. PDF files can be combined with your own reports and secured with a password. The PDF files can then be e-mailed to others and viewed with Adobe's free Acrobat Reader program. See the Adobe Web site for more information. (See <http://www.adobe.com/>)

Using The Pop-Up Menu

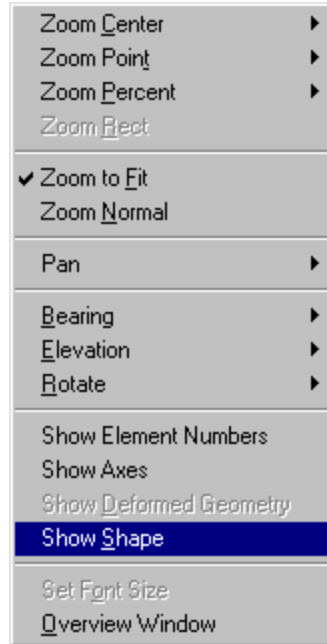

Using the right mouse button or the right mouse tool button (The Geometry View Toolbar), you may alter how the geometry is displayed.

When you are in Zoom-Normal mode then you may use the pop-up menu to:

- Zoom in on the center of the tower by 25%.
- Zoom out on the center of the tower by 25%.
- Zoom in on a point by 25%.
- Zoom out on a point by 25%.
- Zoom in on a rectangular.

Zoom-Fit always fits the tower into the view.

Other actions you can perform:

- Set the Pan command to show instant panning or to only pan after the pan is complete.
- Set the bearing (angle about the vertical axis that the user is viewing the tower) to a specified amount.
- Set the elevation (angle above the ground line that the user is viewing the tower) to a specified amount.
- Rotate left, right, up or down in 5-degree increments.
- Show the finite element numbers and member sizes.
- Show the XYZ axes.
- Show deformed geometry. Available only when a solution is available. Once deformed geometry is turned you may turn it off again by choosing **None** for a load combination to display.
- Show the shapes and orientations of the various members.
- Set the font size for displaying element numbers and member sizes.

- Show the Overview Window. This window allows you to view the entire tower when you have zoomed within the main view. The zoom region is displayed with the overview window as a rectangular with dashed lines.

The Geometry View Toolbar



The toolbar buttons, from left to right, perform the following actions:

- Zoom in.
- Zoom out.
- Zoom in 25% at a selected point.
- Zoom out 25% at a selected point
- Rotate to the left by 5 degrees (bearing angle is shown on the status bar).
- Rotate to the right by 5 degrees.
- Rotate up by 5 degrees (elevation angle is shown on the status bar).
- Rotate down by 5 degrees.
- Right mouse click tool button (for those who do not have a right mouse button).

The rotate buttons may be clicked several times in rapid succession before the program will update the view.

The Overview Window

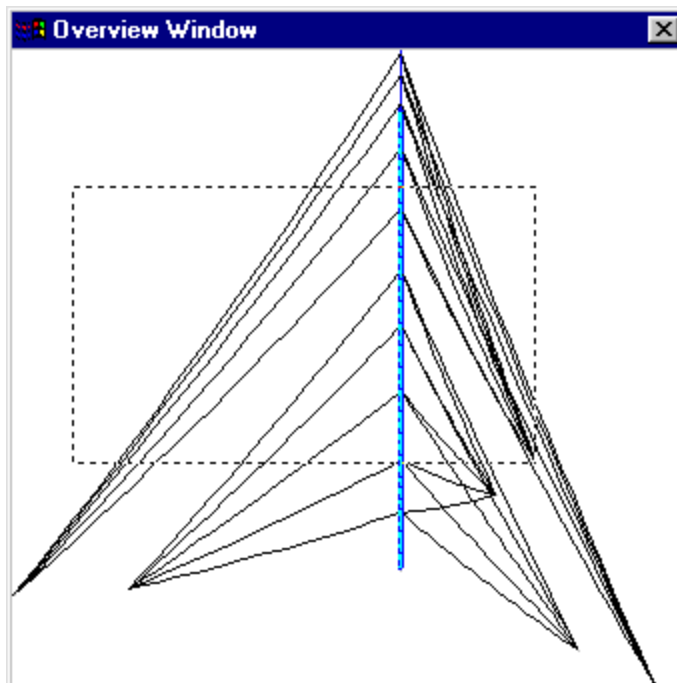

Position the mouse cursor anywhere within the Geometry View and click the right mouse button or the right mouse tool bar button. From the pop-up menu select the Overview Window. The overview window always displays the complete structure and indicates a zoom rectangle to illustrate your current view.

Once the overview window is displayed, you may click anywhere within the zoom rectangle and “drag” the zoom window to a new position. The main geometry view will be updated to the new position.

Material Take-off View

Summary

DESIGNED APPURTENANCE LOADING

TYPE	ELEVATION	TYPE	ELEVATION
SR 3 SW	300	SR 3 SW	300
SR 3 SW	300	SR 3 SW	300

MATERIAL LIST

MARK	SIZE	MARK	SIZE
A	SR 3 SW	F	SR 3 SW
B	SR 3 SW	G	SR 3 SW
C	SR 3 SW	H	SR 3 SW
D	SR 3 SW	I	SR 3 SW
E	SR 3 SW	J	SR 3 SW

TOWER DESIGN NOTES

1. Tower designed for a 80 mph basic wind in accordance with the TIA/EIA-222-F Standards.
2. Tower is also designed for a 70 mph basic wind with 0.500' ice.
3. Weld together tower sections have flange connections. Connections use galvanized A325 bolts, nuts and locking devices. Installation per EIA-222-F and AISC Specifications.
4. Tower members are "hot dipped" galvanized in accordance with ASTM A123 and ASTM A153 Standards.
5. Welds are fabricated with ER-70S-6 electrodes.

This view shows a general engineering summary of the tower. This includes a section-by-section material list on the left side, a graphic depiction of the tower, a brief plan view, tables of appurtenances and notes. In addition, if a solution has been run, reactions and maximum guy anchor forces will also be displayed.

Adding In User Defined Notes

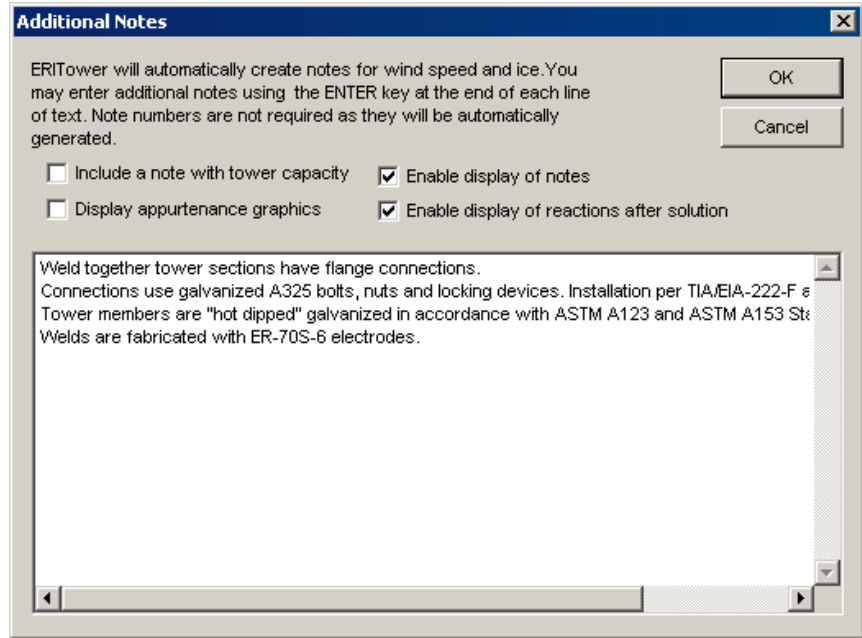

The program predefines certain notes. When there is room, you can add your own notes to the drawing. Simply right click with your mouse, or click on the right mouse toolbar button, and the following dialog box will appear. Each line represents a separate note. When you have run the analysis, the tower capacity can optionally be included as a note.

The **Display Appurtenance Graphics** check box allows you to turn on or off the plotting of graphic symbols that you defined on the Discrete spreadsheet. Dishes are automatically given graphic symbols and will also be plotted.

Plot Plan View

Summary

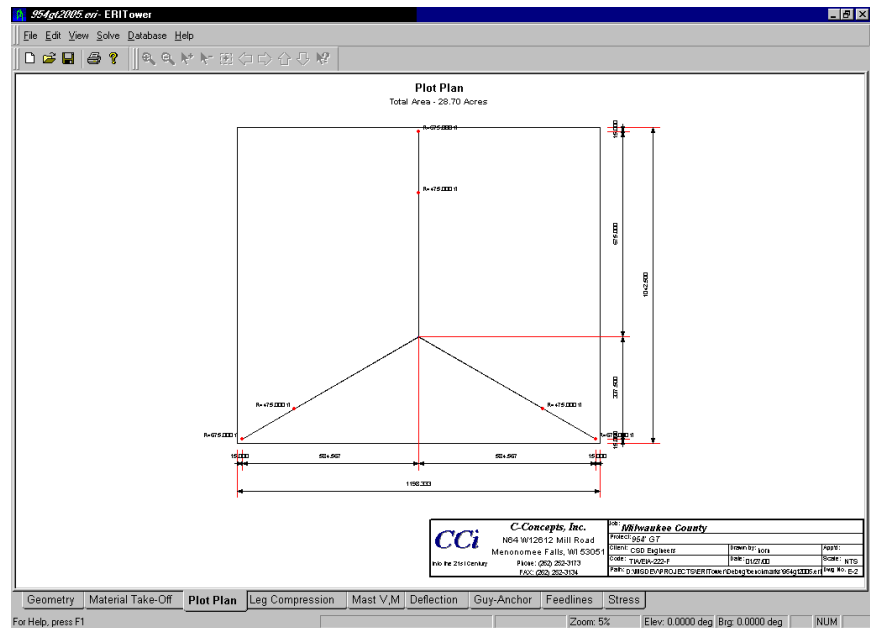

The plot plan shows a plan view of the tower complete with a 15-foot boundary to account for foundations. The total acreage is calculated and shown at the top of the drawing.

Leg Compression View

Summary

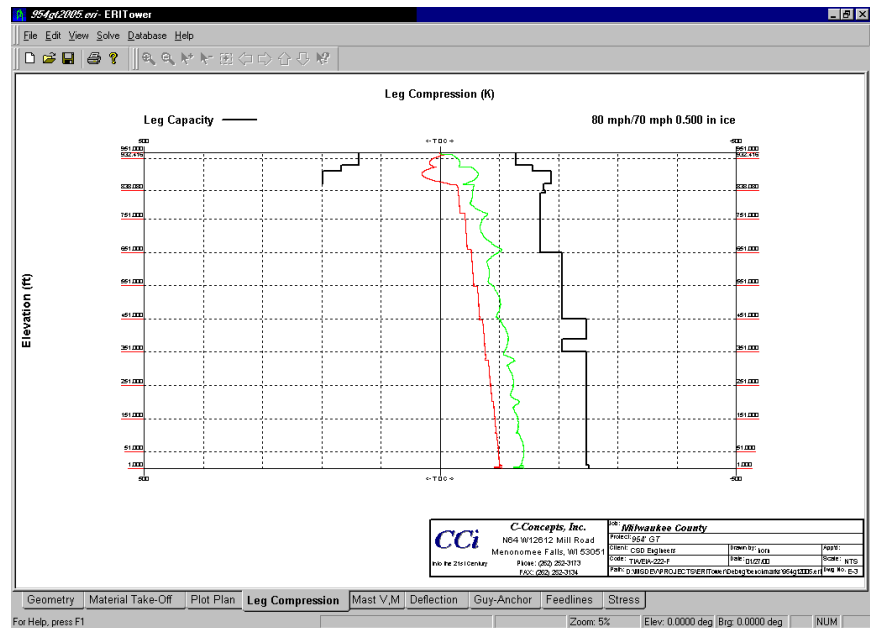

The leg compression view shows both the maximum tension (left half) and maximum compression (right half) forces in the legs. In addition, if a design or check was run, the leg capacity in tension and compression will be drawn in a bold line.

Mast Shear & Moment View

Summary

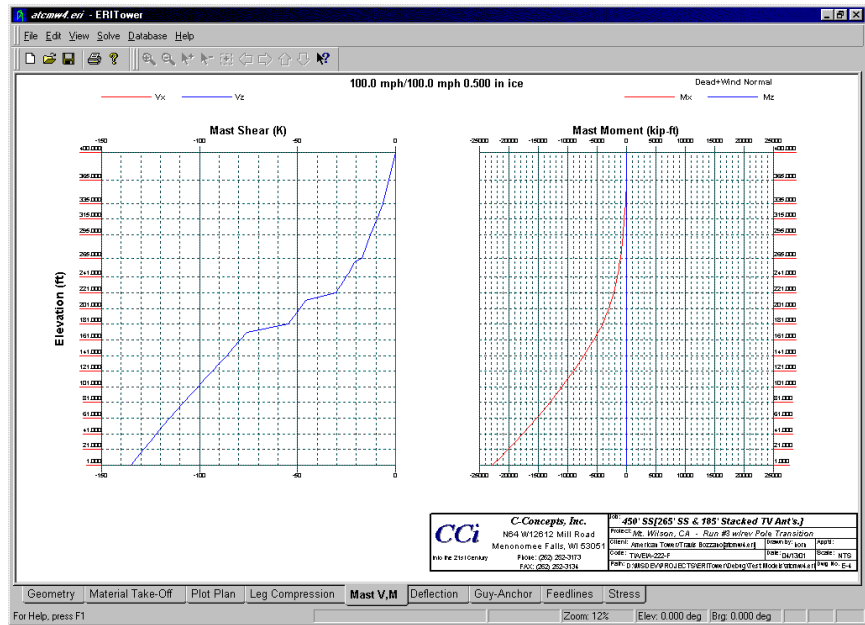

The mast shear and moment view displays a graph of the maximum mast shear and a graph of maximum mast moment for each section in the tower.

Specifying A Load Combination

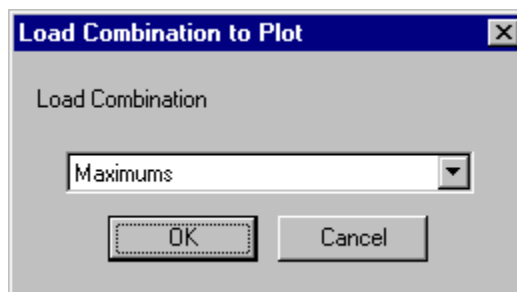

By default, the maximum shears and moments are shown. To show a specific load combination, click with the right mouse button or click on the right mouse toolbar button. Choose a load combination from those shown and click **OK**.

Deflection View

Summary

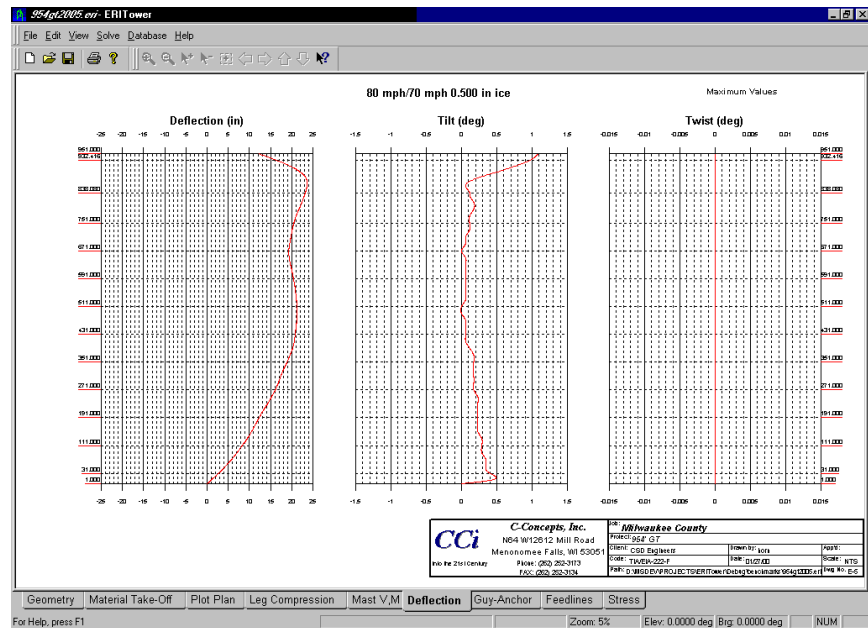

The deflection view displays graphs of deflection, tilt and twist. The deflection is the vector sum of the x and z displacements. The tilt angle is the angle the mast rotates over from the vertical plane. The twist angle is the torsional angle or rotation.

Specifying A Load Combination

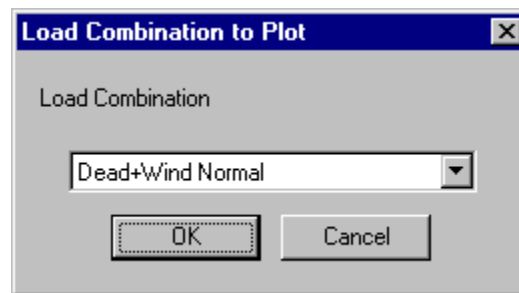

By default, the maximum deflections and rotations are shown. To show a specific load combination, click with the right mouse button or click on the right mouse toolbar button. Choose a load combination from those shown and click **OK**.

Guy Anchor View

Summary

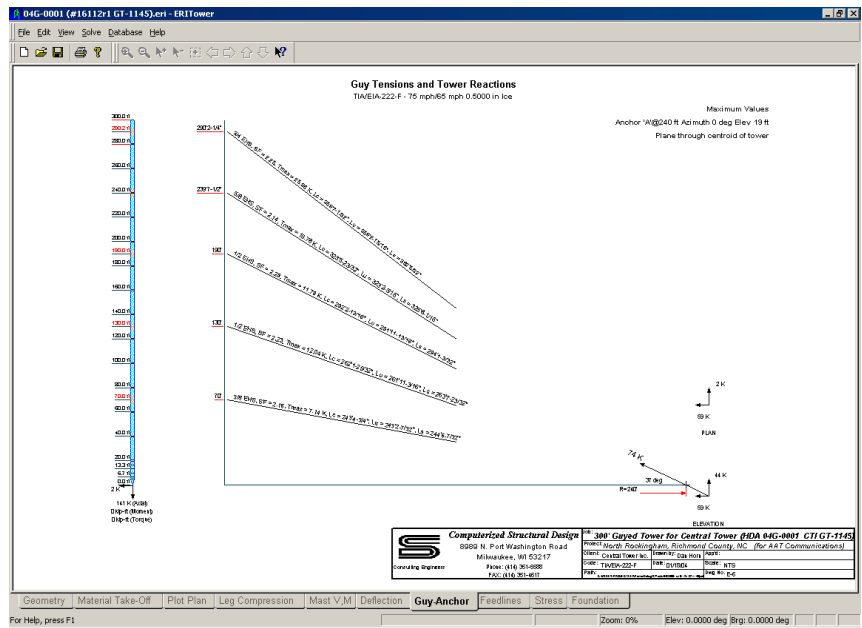

Specifying A Load Combination And Guy Anchor Location

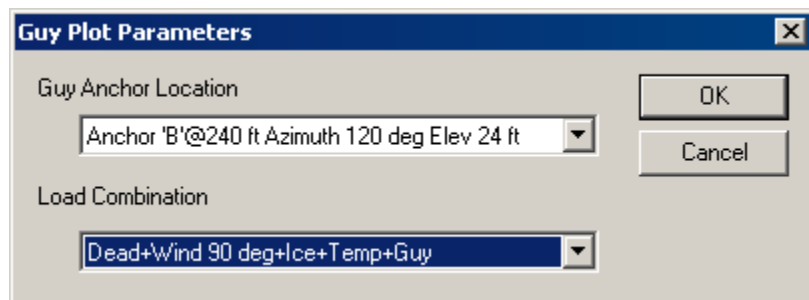

By default, the maximum guy tensions and anchor forces are shown for the most critical guy anchor block. To show a specific load combination and guy anchor location, click with the right mouse button or click on the right mouse toolbar button. Choose an anchor location and load combination from those shown and click **OK**. If you choose Worst for the anchor location, the program will determine which anchor location has the maximum guy tension. When using Maximums for load combinations, note that the tangential force may come from a different load combination than for the vertical and horizontal guy components and may therefore appear not to be in equilibrium.

Feed Line View

Distribution View

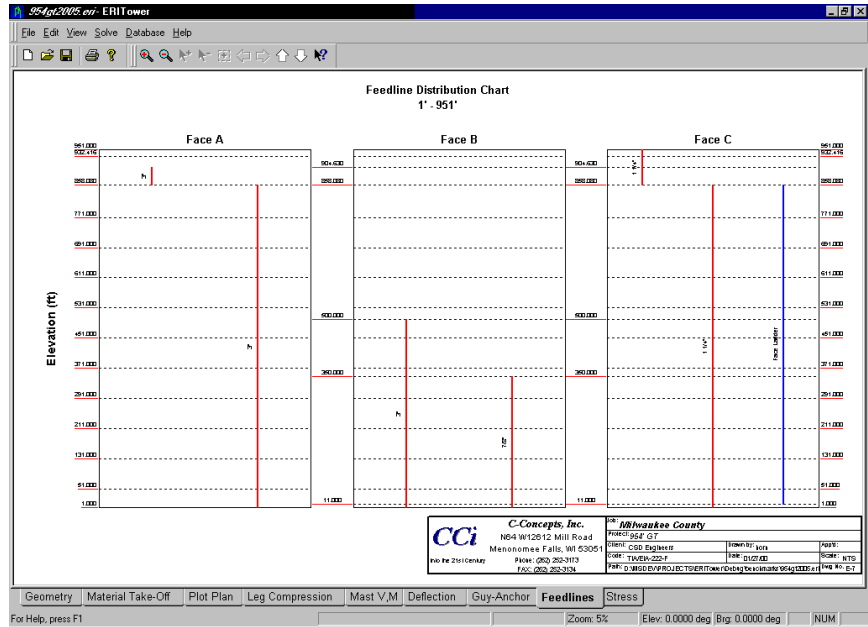

The feed line distribution (default) view graphically displays the locations of feed lines on each face of the tower.

Changing The Elevations Of The View

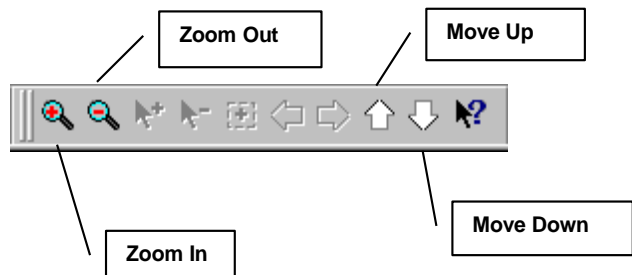

By default, the view shows the entire height of the tower. You may zoom in or out by either using the zoom toolbar or by using the right mouse button.

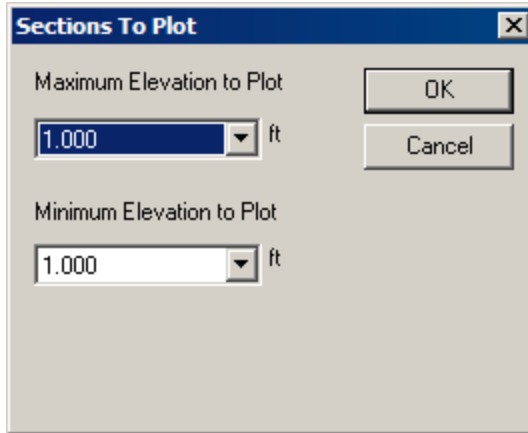

Using the right mouse button or the right mouse toolbar button, you can change the minimum and maximum elevations to be displayed within the view.

Plan View

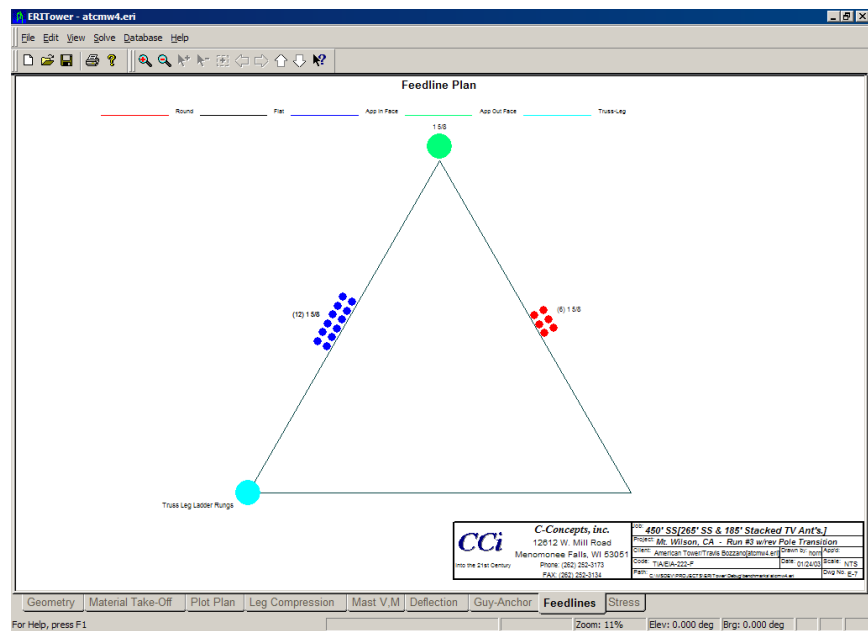

The feed line plan view graphically displays the locations of feed lines at the base section of the tower. This view is only available when the **Consider Feed Line Torque** option has been chosen.

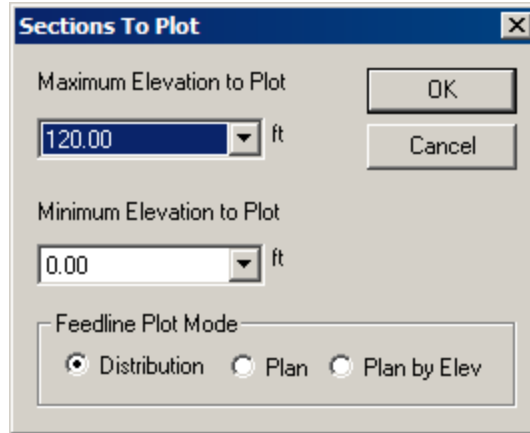

Using the right mouse button or the right mouse toolbar button, you can change the plot mode to **Plan**, **Plan by Elev** or **Distribution**. The elevations to plot are disregarded in the plan view since it only plots the feed lines at the base of the tower. The elevations can be used in the **Plan By Elev** view since this will plot feed lines at various points where the feed lines start and stop.

Stress Distribution View

Summary

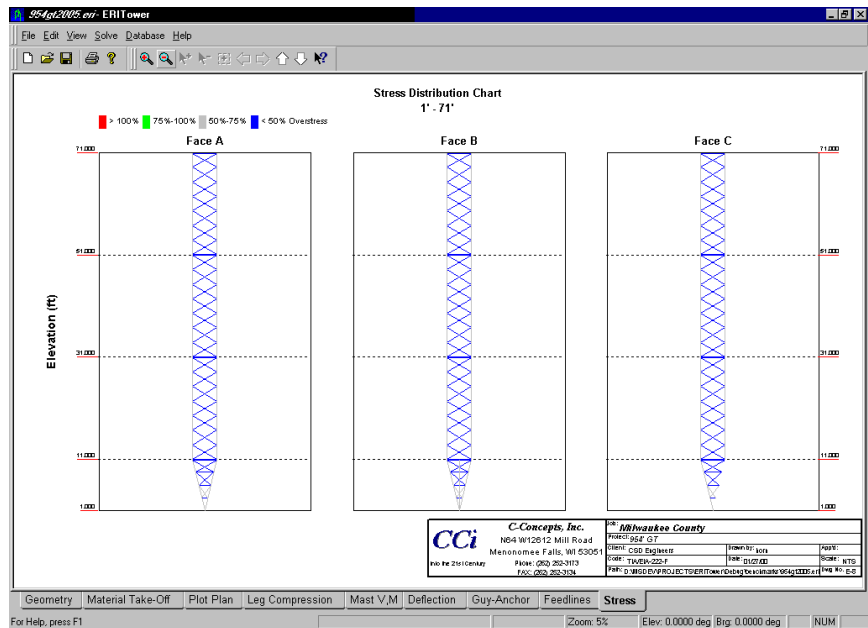

The stress distribution view will graphically show the stress state of the main framing members of the tower. This view will only be available after a stress check or design is performed.

Changing The Elevations Of The View

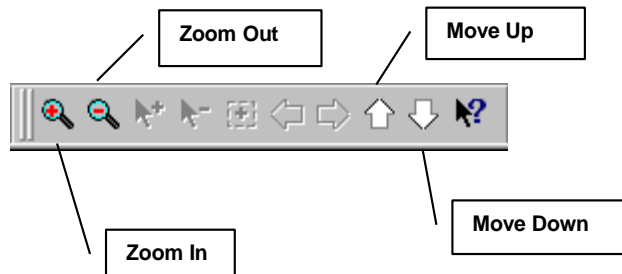

By default, the view shows the entire height of the tower. You may zoom in or out by either using the zoom toolbar or by using the right mouse button.

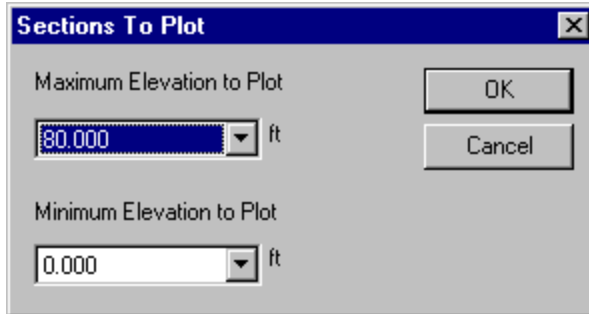

Using the right mouse button or the right mouse toolbar button, you can change the minimum and maximum elevations to be displayed within the view.

Press/Ice View

Summary

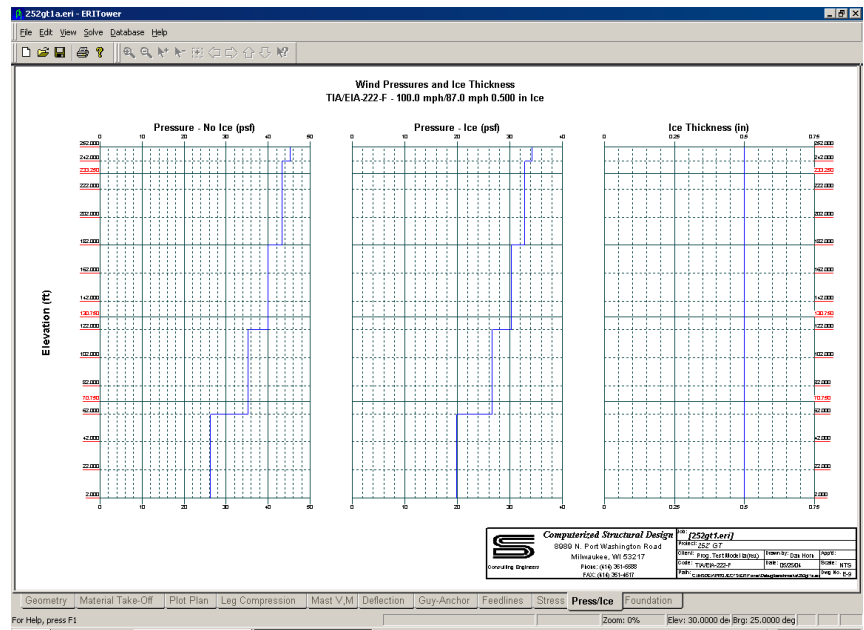

The Press/Ice view shows the distribution of wind pressures and ice thicknesses throughout the height of the tower.

Foundation View

Summary

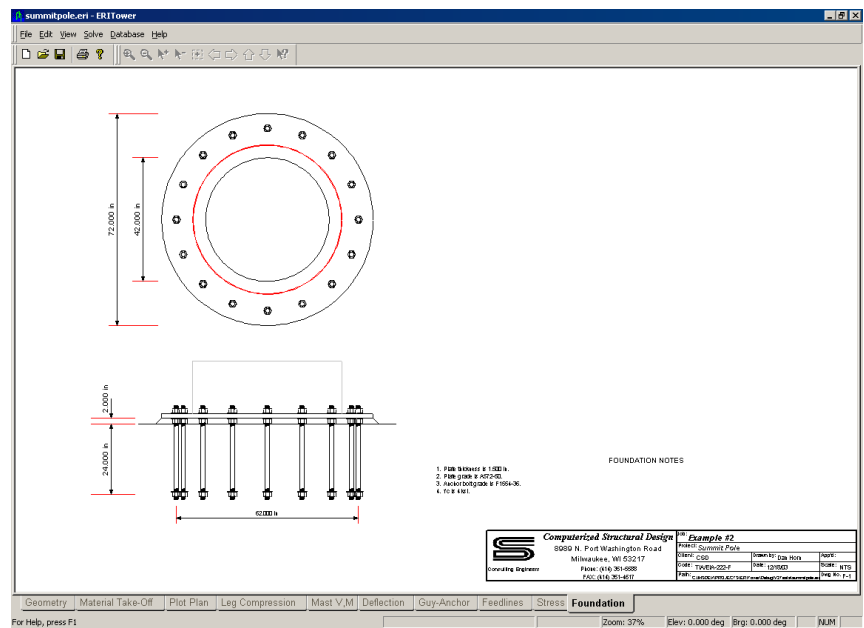

Monopole Base Plates

The foundation view is available for monopole base plates. The view shows both a plan and an elevation view of the base plate and anchor bolts. Future enhancements to the foundation view will include drilled pier details and soil profiles.

Monopoles will have the base plate shown in both plan and elevation views whenever the base plate thickness and bolt circle values are non-zero.

Opening model files in RISA-3D

Overview

tnxTower models may be opened in RISA-3D. This feature provides additional analysis and design capabilities. The exported file includes all geometry, section property, and loading data.

In RISA-3D tower models may be freely modified to simulate variety of project conditions, such as individual member deterioration, local reinforcing, adding/removing components, etc. In addition, seismic analysis is also available. RISA-3D state-of-the-art graphical modeling tools allow visual data input and model manipulation.

Model transfer is initiated by clicking on the RISA-3D toolbar button:

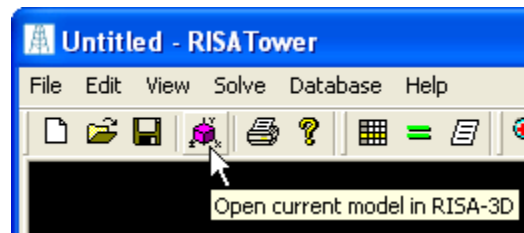

or by selecting File | Open Current Model in RISA-3D:

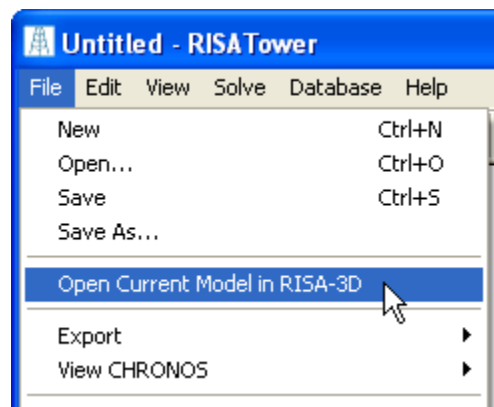

This creates the RISA-3D file of the tower model and launches the program (if not already running).

Model File

tnxTower models, once transferred to RISA-3D are stored in the RT3 file format. These files may be opened by RISA-3D v.7.01 and greater, provided the workstation has a current tnxTower license as well.

The RT3 file contains all geometry and loading information from the original tower model. Structural member shapes are exported as their RISA-3D counterparts. In cases where there is no corresponding RISA-3D shape (e.g., “double channel”) the members are exported as General Shapes. Cross-sectional properties of the original shapes are preserved, however.

Guy members are exported as beam members, as there are no cable elements available in RISA-3D.

Section Sets Naming Convention

All members are assigned to specific section sets. There are section sets created for each member type (i.e., Leg, Horizontal, Diagonal, etc.). The name of each section set is unique and derived from the member’s type and its location within the tower. For instance, diagonals in section T5 of the base tower will belong to section set TWR_DIAG_T5, and top girts in section L1 of the upper tower to ANT_TOP_GIRT_L1.

Exported setting for structural steel design specification in RISA-3D depends on the original model’s tower design code. AISC ASD 9th Edition Specification is selected for TIA/EIA-222-F and earlier revisions, and AISC LRFD 3rd Edition is selected for TIA-222-G and TIA-222-H.

All load cases and load combinations are exported. Since tnxTower has one P-delta flag for all load combinations, that setting is used for all load combinations in RISA-3D.

Currently it is not possible to create a tnxTower model from an RT3 file (i.e., import data from RISA-3D to tnxTower).

Export To Other Programs

Summary

AutoCad DXF

This export option will create a full 3-D ASCII DXF (Data eXchange Format) for AutoCad. Note that tnxTower uses the Y-axis as vertical so you will have to perform a rotation within AutoCad to gain the proper orientation.

Layers are created as follows:

- **Layer 0** Line drawing of the structure.
- **Layer 1** Node numbers.
- **Layer 2** Element numbers.
- **Layer 3** Property type descriptions.

The default drawing has all layers turned on. To view only the structure, turn off all layers except layer 1.

The text size is set to 100 inches. This may be too large for smaller towers. You can do a global text size change within AutoCad to make the text size smaller. Text that appears backwards is actually plotted on a back face of the tower. When you rotate the drawing so that the rear face is in front, the 3D text should appear normal.

SDNF

SDNF (Structural Steel Detailing Neutral File) is used for EDI (Electronic Data Interface) between structural engineering programs and fabricators. Version 3.0 of SDNF is implemented in tnxTower. Currently only Packet 00 and Packet 10 are written but eventually Packet 30 (member end reactions) will also be implemented. The greatest problem in exchanging data is in the member shape descriptions as the naming convention is not universal. As an example, consider a pipe with a designation ROHN 2 STD that fabricators would not understand but is the same as PIPE2SCH40. Other problems arise because towers make use of special section such as bent plate legs, truss legs, 60 degree angles (Schifflerized), arbitrary shapes and double channels none of which are supported at the fabrication software end. A shape-mapping file (SMF) is incorporated in the DBASE\ STEEL\directory. The name of the file is STEEL.SMF. You may edit this file with a text editor to map a property name into a fabricator supported section name. The format of the each line in the file is:

“tnxTower name string” “Fabricator name string”

As an example:

"ROHN TS1.5x11 ga"	"TUBE_1.5_O.D.X.12"
"ROHN TS1.5x16 ga"	"TUBE_1.5_O.D.X.058"
"ROHN 1.5 STD"	"PIPE1-1/2SCH40"
"ROHN 2 STD"	"PIPE2SCH40"
"ROHN 2 X-STR"	"PIPE2SCH80"

The name of the section must begin with a “ and end with a “ so that spaces may be included in the name string.

tnxTower will automatically convert some property shape names if instructed to do so. If you choose the option to capitalize all characters, then minor case letters will automatically be capitalized. If you choose the option to condense spaces with ‘-’, then members that have spaces will have the spaces converted to “-“ (e.g. L2 1/2x2 1/2x1/4 is converted to L2-1/2X2-1/2X1/4).

Most steel detailing software will also require you to create a SDNF conversion file to further translate the profile names into the detailing software system’s particular profile names. Steel detailing software, such as X-Steel, have a mandatory requirement that all profile names that are being imported in the SDNF file also must appear in the conversion file or else the member will be ignored.

ASCII Cost Output

This export option will take the cost output of tnxTower (a complete run and design or check must have been completed) and export it to a comma-delimited file. This file can then be imported into spreadsheet programs such as Excel.

Viewing tnxTower Model Files

Sending Files To Clients

Your clients can view your model files and, if the necessary files are sent to the client, they can also view the solution plots and output from the tnxTower program. The full version of the tnxTower program is required to view models and results.

List of Necessary Files

File Name
XXXXX.eri
Optional Files
[LOGO]b.bmp Corporate logo bitmap black background
[LOGO]w.bmp Corporate log bitmap white background
Solution Files
XXXXX.eri.CACT.bin
XXXXX.eri.CAPFILE.bin
XXXXX.eri.COMBS.bin
XXXXX.eri.DISP.bin
XXXXX.eri.DITWIST.bin
XXXXX.eri.GUYTENS.bin
XXXXX.eri.LEGC.bin
XXXXX.eri.PDDIS.bin
XXXXX.eri.RLEGS.bin
XXXXX.eri.RSUMZP.bin
XXXXX.eri.VMCAP.bin
XXXXX.eri.VMMASTX.bin
XXXXX.eri.struct.idx
XXXXX.eri.struct.out
XXXXX.eri.out.rtf

The model file (.eri) is required for viewing the basic tower. When you want the client to have the ability to view solution plots, then the solution files must also be set to the client.

The client must copy the corporate logo files to the directory where tnxTower resides. All model and solution files can be stored at any location on the client's computer. Logo files are optional. Should the logo bitmap files not be sent to the client, the corporate logo will appear blank.

Summary

Overview

tnxCable is an optional program (purchased separately) for calculation of cable tension changes due to temperature differences. The program will also calculate the tangent intercept distance that may be used to determine the tension in a guy wire (Annex K: Measuring Guy Tensions, Section B in TIA-222-G or TIA-222-H).

tnxCable requires that tnxTower is installed first. It uses tnxTower Registry data and tnxTower guy wire databases. Any changes to the databases need to be made through the tnxTower GUI.

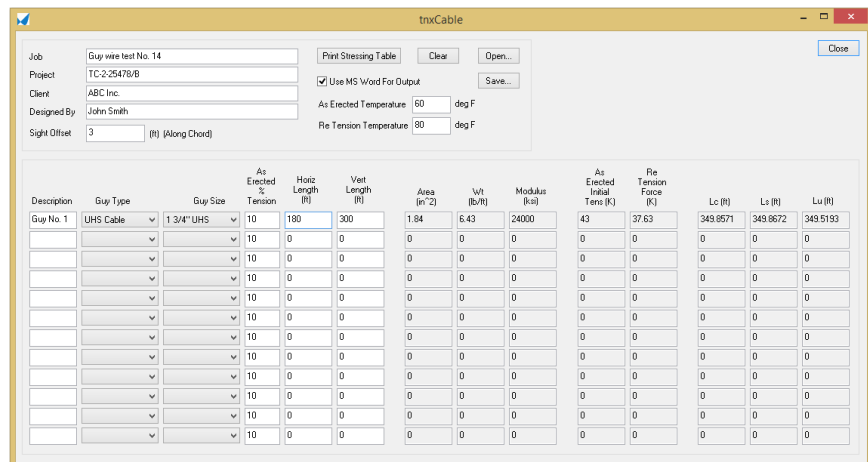

The interface of the program includes the following items:

Data Entered by the User

Job, Project, Client, Designed By – Project information and description.

Use MS Word For Output - When selected, the program will use MS Word (if present) to output the report. Otherwise, the output file will still be generated but not opened. The output file is created in the same folder where the tnxCable input file is located.

As-Erected Temperature - The guy temperature at the time of the original guy tensioning.

Re-Tension Temperature – The guy temperature when the re-tensioning is performed.

Sight Offset – The distance, along the chord of the guy, from the assumed anchorage point to the point where the line of sight is tangent to the cable.

Description - A label that will identify the guy for which calculations are performed. It is necessary to enter this text first to activate the balance of the input fields in the row.

Guy Type - One of the four types included in the tnxTower database: EHS, BS, UHS, and Miscellaneous.

Guy Size – A specific guy designation from sizes included in the database.

As Erected % Tension - The original guy pre-tensioning force expressed as a percentage of its breaking strength.

Horizontal Length – The horizontal distance between the start and the end of the cable.

Vertical Length – The vertical distance between the start and the end of the cable. The distance is fixed for a given cable profile and does not change with temperature.

Data Retrieved from the Database

Area. Metallic area of the cable.

Wt. Linear weight of the cable. The data should include any additional weight due to ice, etc.

Modulus. Modulus of elasticity of the cable.

Values Calculated by the Program

As Erected Initial Tension. Initial tension force at the as-erected temperature (based on a percentage of the guy breaking strength).

Re-Tension Force. The required value of the tension force at the re-tension temperature to ensure the initial tension force value at a temperature equal to the as-erected temperature.

Lc. The cord length of the cable.

Ls. The stressed length of the cable.

Lu. The unstressed length of the cable.

tnxCable Report

The printed output of the program includes the following calculated values:

For the initial tension and temperature: guy angle at the anchor, guy chord angle, chord cable length, unstressed cable length.

For 12 temperature values below and above the As-Erected Temperature: stressed cable length, intercept for the sight line tangent at anchor, intercept for the sight line tangent at offset point, guy tension at tower, anchor, and average.

Before you begin

Candelabra import page is disabled by default. To change that setting, go to File → Settings and select the Display and Printing tab. Under Features make sure that the Enable Candelabra Data Entry box is checked. Click OK.

Summary

tnxTower can analyze and design tower models with candelabras. Candelabra creation and/or editing is done in RISA-3D, which provides state-of-the-art graphical modeling tools.

The ability to export tnxTower models to RISA-3D allows to use the base tower as a reference for easy definition of candelabra geometry and its tower attachment points. The candelabra structure geometry may then be imported into a tnxTower model. Additional information, such as height above base and loads, are specified in tnxTower on the Candelabra input screen.

In the finite element analysis of the aggregate model full interaction between candelabra and base tower members is assumed. Loads applied to the candelabra (except for candelabra structural members' self-weight) are generated based entirely on projected areas and antenna forces entered by the user on the candelabra data input page (i.e., the program currently does not calculate projected areas from individual members geometry data).

The candelabra geometry information is stored in an external file (extension rt3 or r3d). This file must always be available when a tower model that was defined with the candelabra is being opened.

It is also possible to import the old-style candelabra files (extension .txt). RISA Technologies does not support those files, however. We recommend that those candelabra models be converted to .rt3 files by exporting the tower with the old-style candelabra attached to RISA-3D, deleting two of the three candelabra arms, editing the third arm if needed, and saving the file in the .rt3 format. These steps are very similar to those described in Method 1 below.

Using the Candelabra Editor

Only one arm of a candelabra must be defined in RISA-3D. When the candelabra is imported, this one arm will be replicated to every side of the tnxTower model. If the candelabra model in RISA-3D comprises all three arms (for example, the model was exported from tnxTower with the candelabra attached), it is necessary to delete two of the arms before saving the candelabra file for importing it into tnxTower.

The candelabra arm must be symmetrical about a vertical longitudinal plane (coincident with the arm's longitudinal axis).

There are two ways to model candelabras in RISA-3D:

- Method 1:** Opening a tnxTower model in RISA-3D and attaching the candelabra to it.
- Method 2:** Creating the candelabra as an entirely new model in RISA-3D

**Step-by-step
instructions: Method 1**

This is the simpler and less error-prone method of the two. We recommend using it whenever possible.

- Create a model of the base structure (without candelabra) in tnxTower.

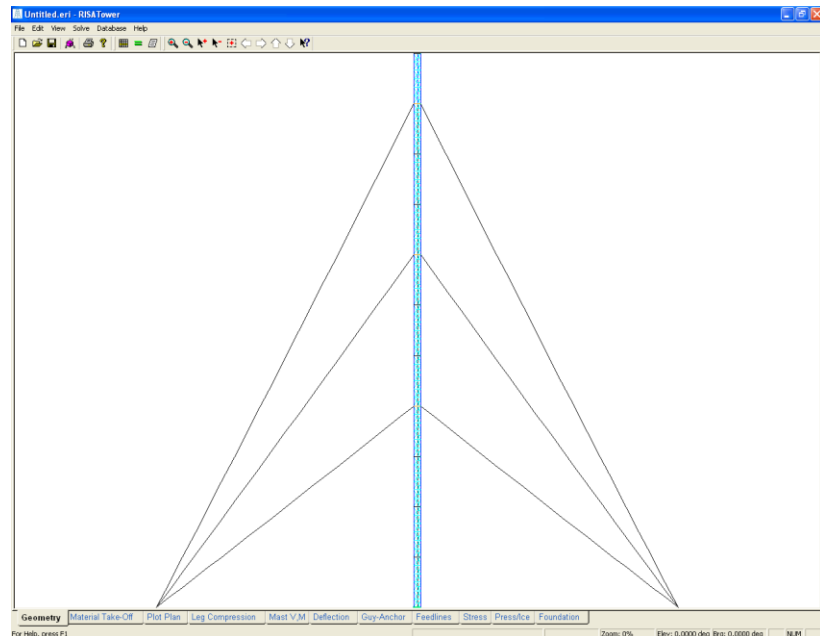

- Export the model to RISA-3D by hitting the  button located in the toolbar at the top of the window.
- In RISA-3D, model ONLY ONE ARM of the candelabra (on one face of the tower only).

Important: Please refer to the “Modeling Candelabras in RISA-3D : Method 1” section of this documentation for further instructions.

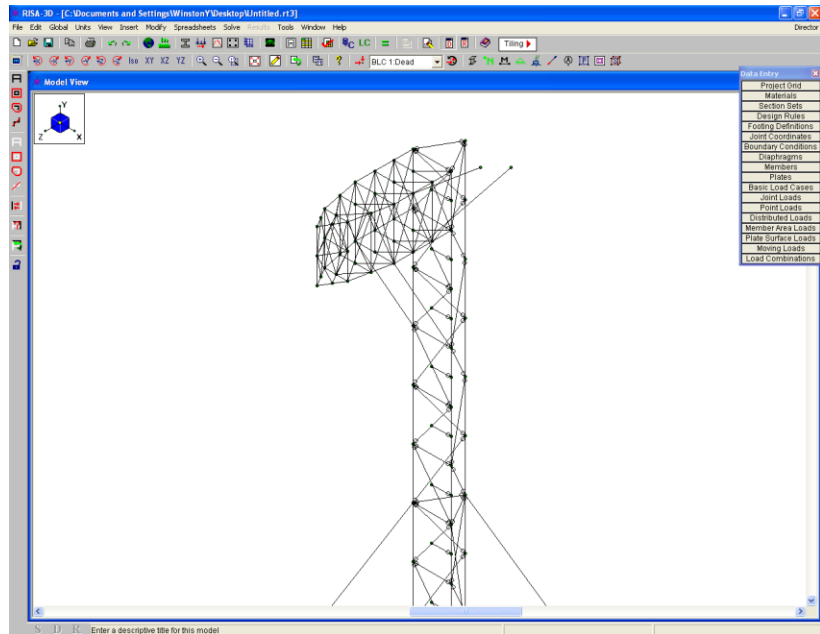

- Save the candelabra file. This file has an “rt3” extension and is saved by default in the same directory where your tnxTower file resides.
- Go back to tnxTower. If you have closed tnxTower already at this point, start the application again and open the model of the base structure (previously exported to RISA-3D).
- Go to the Tower Data input screen by selecting *Edit* → *Tower Data* from the main menu or by clicking the  button in the toolbar.
- Select the *Candelabra* tab. If this tab is not available, refer to the subsection “Before you begin” at the start of this Candelabra Editing and Import chapter.

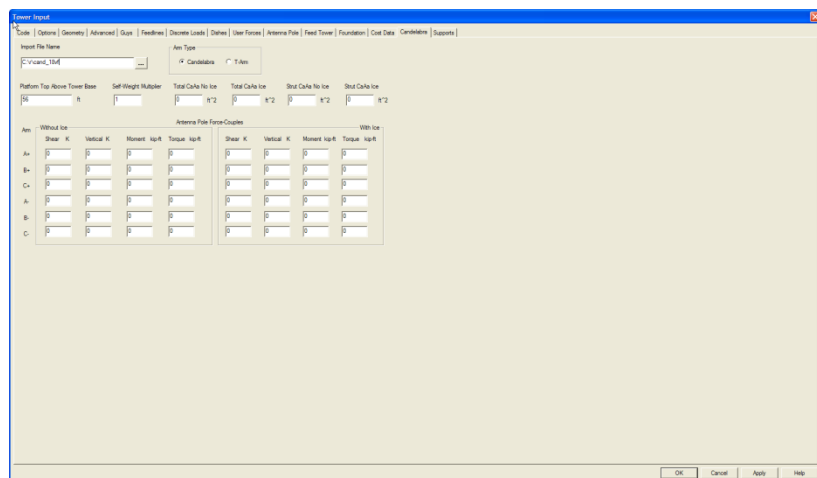

- Click the **...** button as highlighted below and select the .rt3 candelabra file, previously saved by RISA-3D.

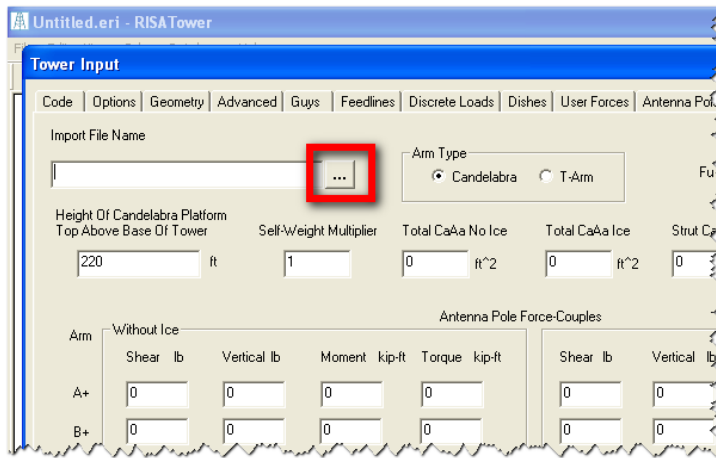

- Fill in the rest of the information for the candelabra and click OK. The candelabra (if modeled correctly) will attach to the tnxTower base structure. The input for “Platform Top Above Tower Base” height will determine the location of the candelabra on the tower.

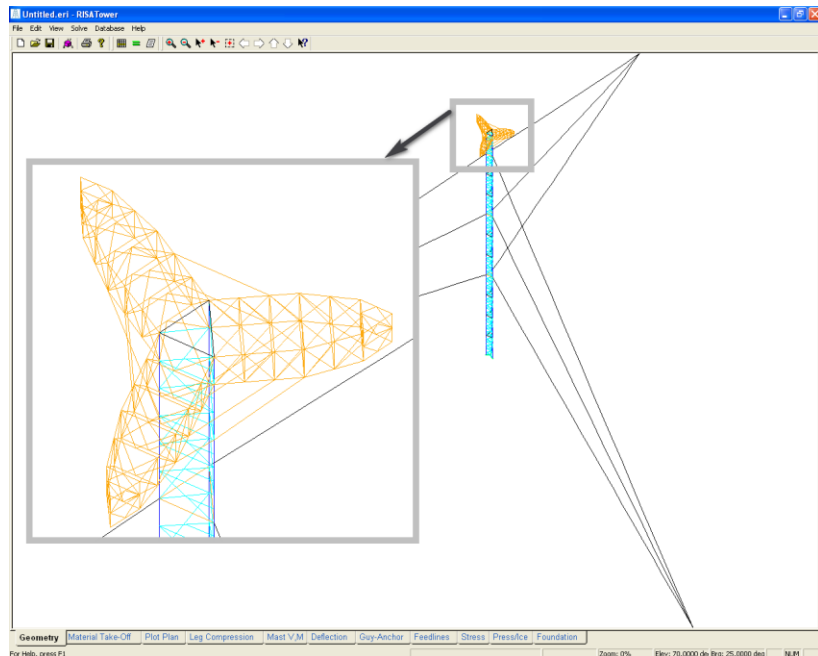

**Step-by-step
instructions: Method 2**

May be used when the base structure tnxTower model is not available or cannot be exported to RISA-3D. The candelabra is defined entirely within the RISA-3D environment, assuming that the global vertical axis of the program coincides with the plane of one of the base tower faces. Please note that certain characteristics of the candelabra structure and the tower (horizontal and vertical distances between points of attachment) must match to ensure successful candelabra import in tnxTower.

- Start RISA-3D.
- Model ONLY ONE ARM of the candelabra using program axes as reference for member definition.

Important: Please refer to the “Modeling Candelabras in RISA-3D : Method 2” section of this documentation for further instructions.

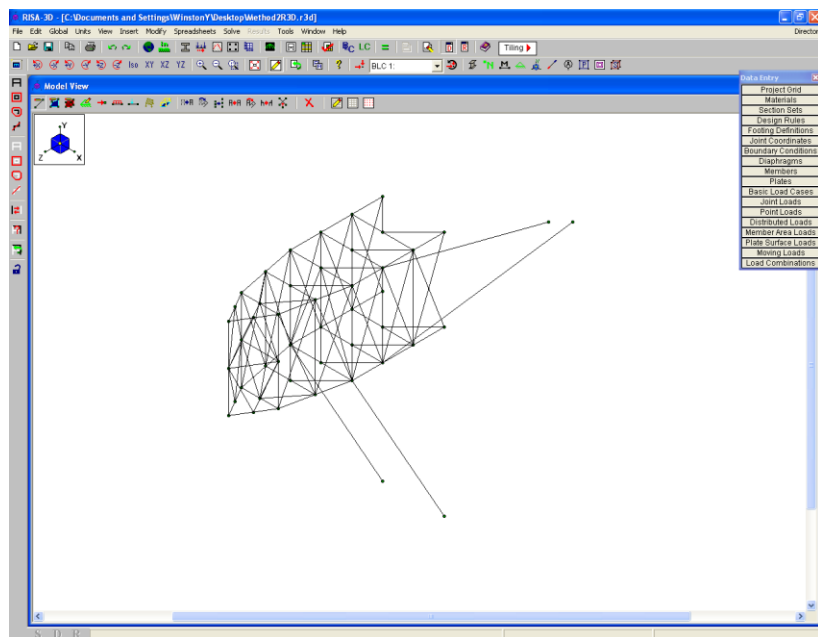

- Save the file in the default RISA-3D format “r3d”.

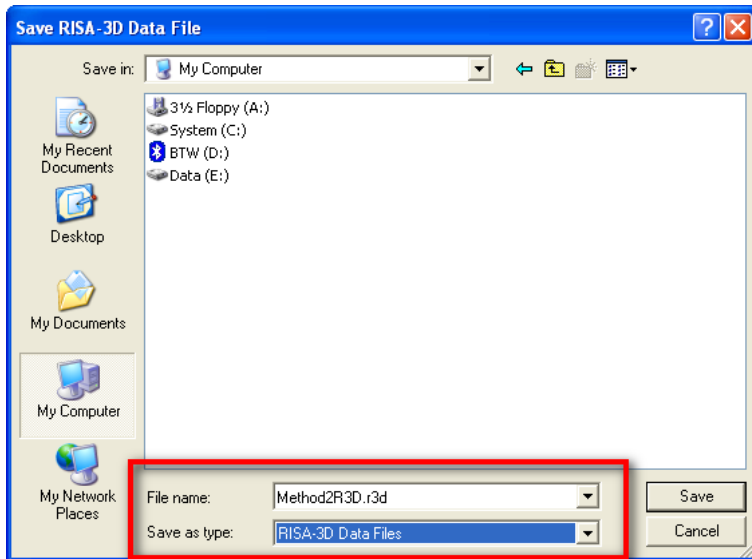

- In tnxTower, open the model that should receive the candelabra. Go to the Tower Data input screen by selecting *Edit* → *Tower Data* from the main menu or by clicking the  button in the toolbar.
- Select the *Candelabra* tab. If this tab is not available, refer to the subsection “Before you begin” at the start of this Candelabra Editing and Import chapter.

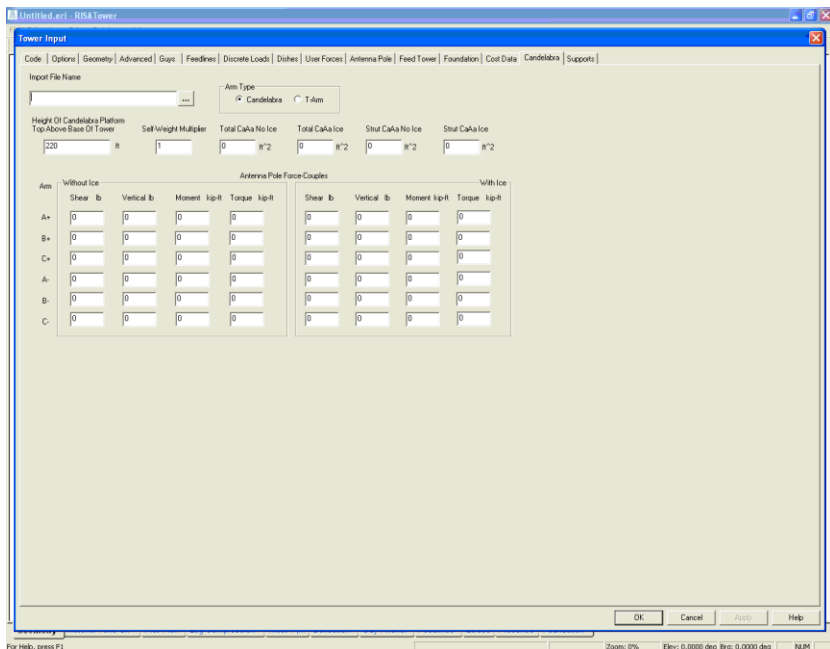

- Click the  button as highlighted below to bring up the candelabra file selection dialog box.

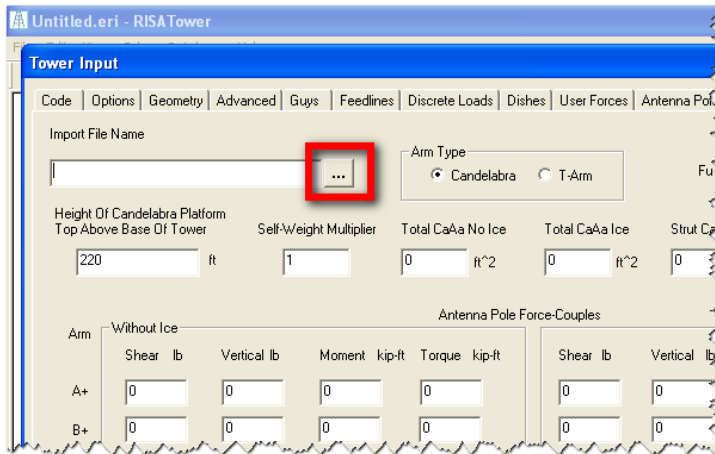

- In the “Select File” dialog box, set “Files of type:” option to “RISA-3D Data Files (*.r3d)”, navigate to the location of the candelabra file, select it, and click OK.

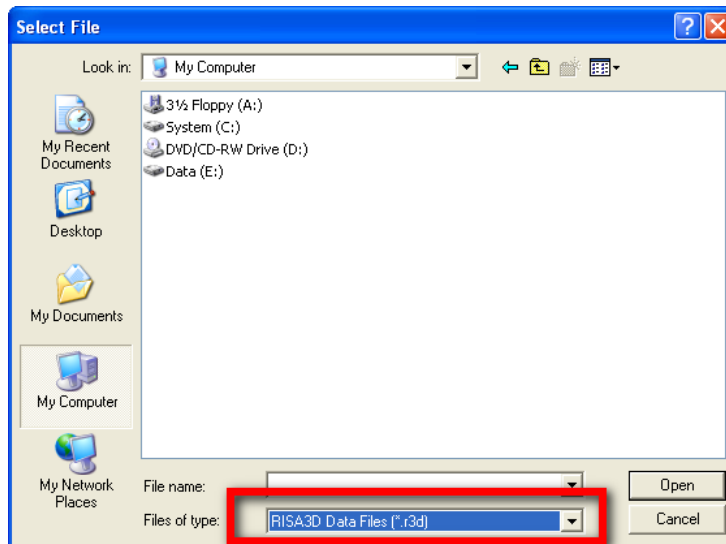

- Fill in the rest of the information for the candelabra and click OK. The candelabra (if modeled correctly) will attach to the tnxTower base structure. The input for “Height Of Candelabra Platform Top Above Base Of Tower” will determine the location of the candelabra on the tower.

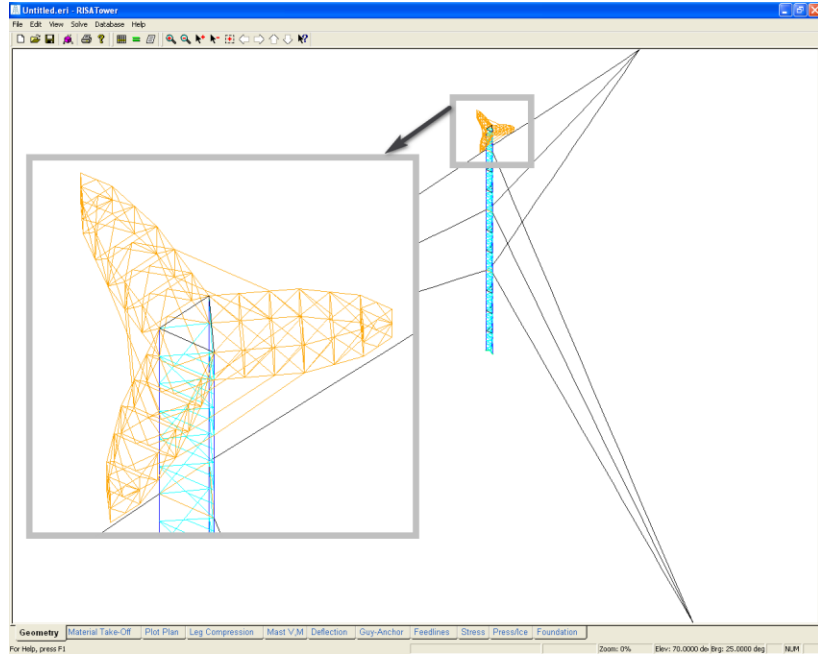

Attaching Guys to Candelabra

This is done in tnxTower AFTER a candelabra has been imported. Guy cables always attach to either the top or the bottom node of the candelabra leg member.

- Go to *Edit* → *Tower Data* in the main menu or click the  button.
- Select the *Guys* tab. The entries for existing guys will already be in the spreadsheet.
- Start a new guy definition by entering the mounting “Height Above Base”. If the number entered does not exactly match the height of an end of the candelabra leg, the guy will snap to the nearest leg end (top or bottom).

Tower Input											
Code	Options	Geometry	Advanced	Guys	Feedlines	Discrete Loads	Dishes	User Forces	Antenna Pole	Feed Tower	Foundation
	Height Above Base (ft)	Mount Type	Guy Grade	Auto Correct Height	All Guys Identical	All Anchors Identical	Size	% Initial T			
1	200.00	Corner	EHS	<input checked="" type="checkbox"/>	<input type="checkbox"/>	<input type="checkbox"/>	1/2	10			
2	140.00	Corner	EHS	<input checked="" type="checkbox"/>	<input type="checkbox"/>	<input type="checkbox"/>	1/2	10			
3	60.00	Corner	EHS	<input checked="" type="checkbox"/>	<input type="checkbox"/>	<input type="checkbox"/>	1/2	10			
4	220.00	Candelabra Corner R	EHS	<input checked="" type="checkbox"/>	<input type="checkbox"/>	<input type="checkbox"/>	1/2	10			
5				<input type="checkbox"/>	<input type="checkbox"/>	<input type="checkbox"/>					
6				<input type="checkbox"/>	<input type="checkbox"/>	<input type="checkbox"/>					
7				<input type="checkbox"/>	<input type="checkbox"/>	<input type="checkbox"/>					

- Next, select the mount type. There are 3 candelabra mount types available:

1. Candelabra

Guys connect to candelabra legs on both left and right sides:

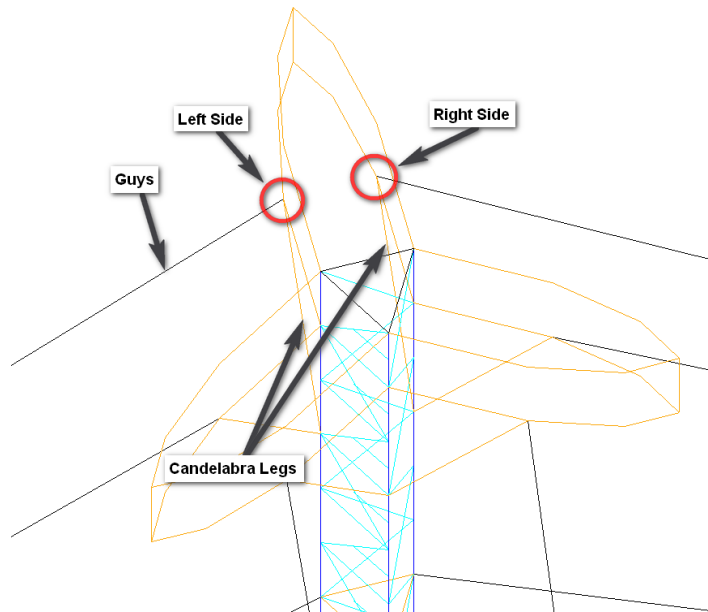

2. Candelabra Corner L

Guys connect to the left sides only:

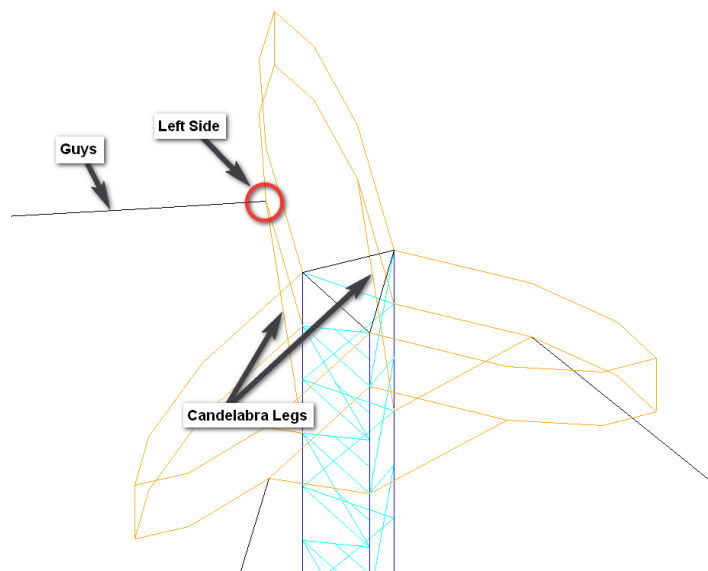

3. Candelabra Corner R

Guys connect to the right sides only:

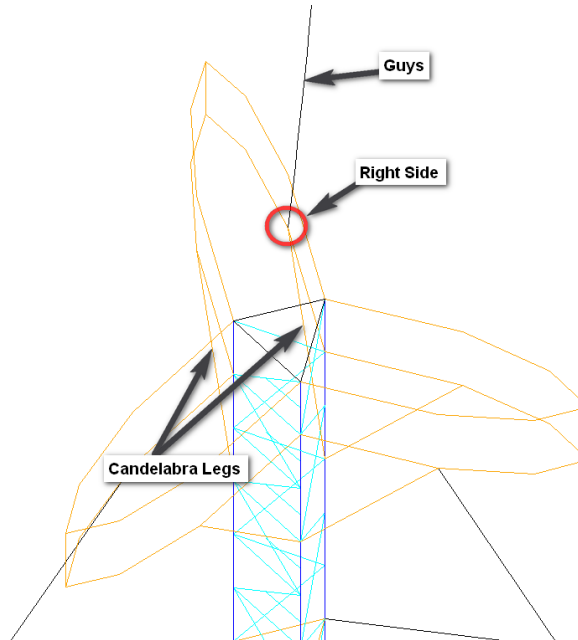

- Fill in the rest of the guy information and click OK.

Modeling candelabras in RISA-3D

This tutorial describes how an example candelabra model is created using RISA-3D graphical tools. Please refer to the documentation of RISA-3D for detailed explanation of its features and extensive instructions on how to use it.

Method 1: Attached to the tower model

The first step is to export the base tower model from tnxTower to RISA-3D. Make sure that you have your specific tower model visible in the main window of RISA-3D. In this tutorial, the default tower, generated when *File* → *New* is selected in tnxTower, is used as an example.

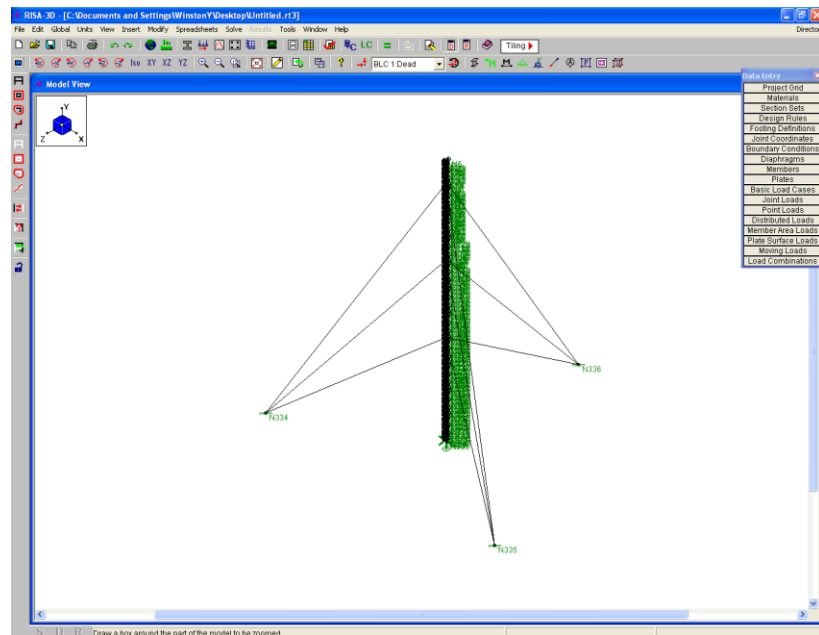

1. Zoom into the part of the tower where you want the candelabra connected to by using the mouse scroll wheel.
2. We want to model the top side of the candelabra first. To assist in “drawing” the candelabra, the grid feature of RISA-3D can be used. To do this, select *Insert* → *Grid*

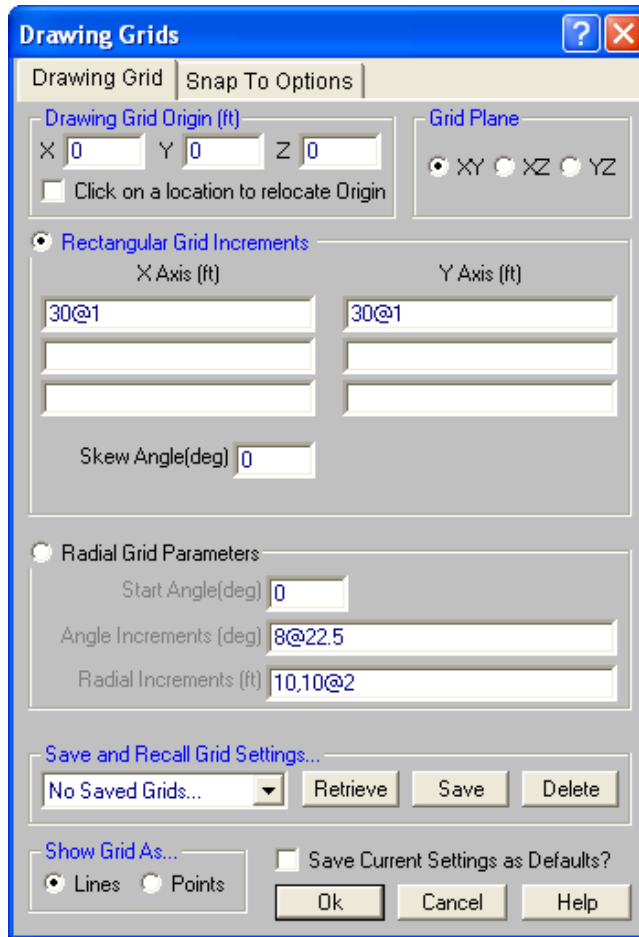



3. Check the box that says “Click on a location to relocate Origin” to be able to choose the starting point of your grid.
4. The “top” side of the candelabra is on a horizontal plane, therefore change “Grid Plane” to “XZ”.

Note: If the y-axis is not your vertical axis, choose another vertical plane, consistent with the orientation of the axes.

5. To fill the “Rectangular Grid Increments” section, first determine what the “Face Width” of your tower is by going to *tnxTower* and with the same tower model open, select *Edit* → *Tower Data* → *Geometry*. Divide the face width into a suitable number of segments – they will represent the size of your grid increment. In our case the Face Width is 2.5ft and it has been divided into 10 segments 0.25ft each.

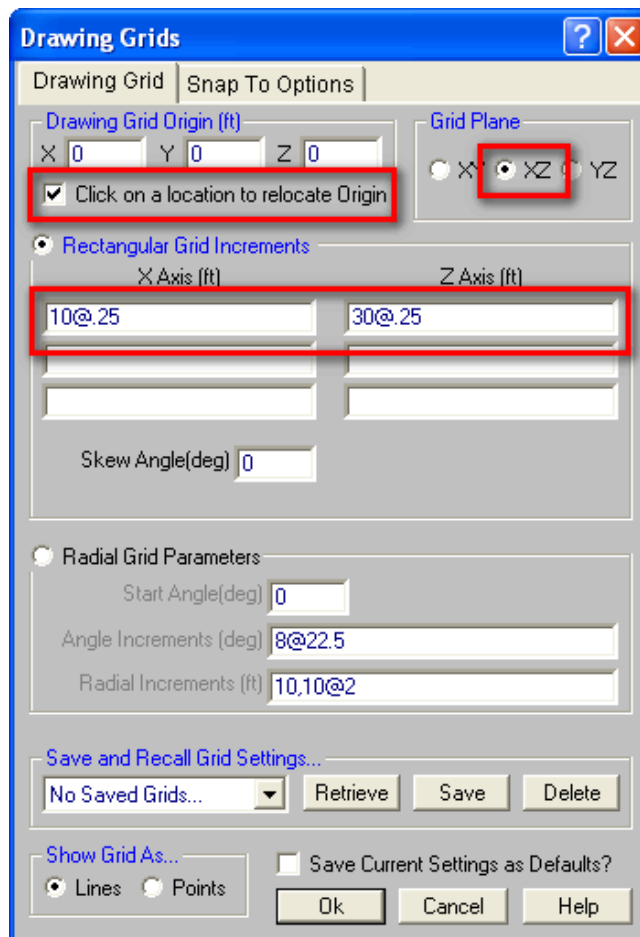
“10@0.25” and “30@0.25” are entered in the first lines of “X-Axis” and “Z-Axis”, respectively. This can be interpreted as “10 segments at 0.25ft in the x-direction and 30 segments at 0.25ft in the z-direction”. There are more segments in the z-direction because we want a candelabra that is longer than it is wide. When finished, the “Drawing Grids” dialog will look like the following:



- Click OK and the cursor will change to . Select the following joint of the tower:

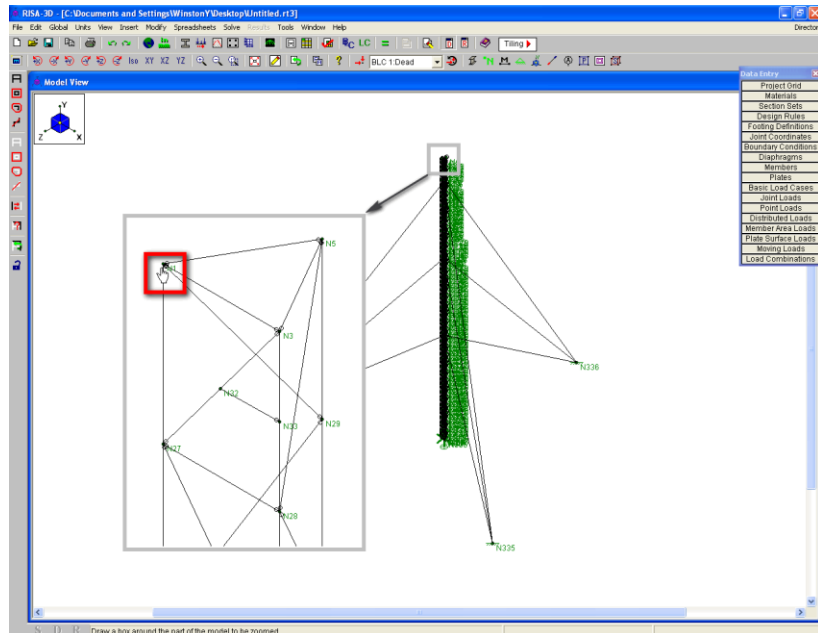

- Before you start the actual candelabra model, RISA-3D needs to know that what you are about to draw is a candelabra member. When the candelabra file is later imported by `tnxTower`, only members designated as such will be transferred and attached to the tower model.

RISA-3D keeps track of different classes of members using the concept of a Section Set. This feature allows users to define a section template that may be used repeatedly, eliminating the need to re-enter member properties for identical shapes in multiple locations within a model. For more information refer to RISA-3D User Guide.

Section Set property will identify members as candelabra members of a specific type (e.g., primary horizontal, candelabra leg, etc.). See the “Candelabra Section Sets” table in this Chapter for more information before proceeding further.

- To set up the section sets, go to *Spreadsheets* → *Section Sets*. A spreadsheet that is already filled will appear:

Label	Shape	Type	Design List	Material	Design Rul.	A [in ²]	Iy [in ⁴]	Iz [in ⁴]	J [in ⁴]
TWR_LEG_T1	SR 1 1/2	Column	Round Default	A572-50	Typical	1.767	.249	.249	.497
TWR_TOP_GIRT_T1	Flat Bar 2x1/2	Beam	None	A36	Typical	1	.021	.333	.07
TWR_PULLOFFTOP_T2	SR 1 1/4	Beam	Round Default	A572-50	Typical	1.227	.12	.12	.24
TWR_K_BRACE_T1	SR 9/16	Column	Round Default	A36	Typical	.249	.005	.005	.01
TWR_HORZ_T1	SR 3/4	Beam	Round Default	A36	Typical	.442	.016	.016	.031
TWR_DIAG_T1	SR 9/16	Column	Round Default	A36	Typical	.249	.005	.005	.01
TWR_STEP_T1	SR 5/8	Beam	Round Default	A36	Typical	.307	.007	.007	.015
TWR_LEG_T2	SR 1 1/2	Column	Round Default	A572-50	Typical	1.767	.249	.249	.497
TWR_TOP_GIRT_T3	Flat Bar 2x1/2	Beam	None	A36	Typical	1	.021	.333	.07
TWR_K_BRACE_T2	SR 9/16	Column	Round Default	A36	Typical	.249	.005	.005	.01
TWR_HORZ_T2	SR 3/4	Beam	Round Default	A36	Typical	.442	.016	.016	.031
TWR_DIAG_T2	SR 9/16	Column	Round Default	A36	Typical	.249	.005	.005	.01
TWR_STEP_T2	SR 5/8	Beam	Round Default	A36	Typical	.307	.007	.007	.015
TWR_LEG_T3	SR 1 1/2	Column	Round Default	A572-50	Typical	1.767	.249	.249	.497
TWR_TOP_GIRT_T4	Flat Bar 2x1/2	Beam	None	A36	Typical	1	.021	.333	.07
TWR_K_BRACE_T3	SR 9/16	Column	Round Default	A36	Typical	.249	.005	.005	.01
TWR_HORZ_T3	SR 3/4	Beam	Round Default	A36	Typical	.442	.016	.016	.031
TWR_DIAG_T3	SR 9/16	Column	Round Default	A36	Typical	.249	.005	.005	.01
TWR_STEP_T3	SR 5/8	Beam	Round Default	A36	Typical	.307	.007	.007	.015
TWR_LEG_T4	SR 1 1/2	Column	Round Default	A572-50	Typical	1.767	.249	.249	.497
TWR_PULLOFFTOP_T5	SR 1 1/4	Beam	Round Default	A572-50	Typical	1.227	.12	.12	.24
TWR_K_BRACE_T4	SR 9/16	Column	Round Default	A36	Typical	.249	.005	.005	.01
TWR_HORZ_T4	SR 3/4	Beam	Round Default	A36	Typical	.442	.016	.016	.031
TWR_DIAG_T4	SR 9/16	Column	Round Default	A36	Typical	.249	.005	.005	.01
TWR_STEP_T4	SR 5/8	Beam	Round Default	A36	Typical	.307	.007	.007	.015
TWR_LEG_T5	SR 1 1/2	Column	Round Default	A572-50	Typical	1.767	.249	.249	.497
TWR_TOP_GIRT_T6	Flat Bar 2x1/2	Beam	None	A36	Typical	1	.021	.333	.07
TWR_K_BRACE_T5	SR 9/16	Column	Round Default	A36	Typical	.249	.005	.005	.01
TWR_HORZ_T5	SR 3/4	Beam	Round Default	A36	Typical	.442	.016	.016	.031

- Scroll to the bottom of the spreadsheet and hit *Enter*. This will add a line to the bottom. Enter Section Sets that you will use for your candelabra model. Refer to the “Candelabra Section Sets” table for section set names. Alternatively, you may enter all listed section sets and use only the ones you need, which is what this tutorial will do.

In addition to the section set names, only the selected columns (see below) need to be entered in the spreadsheet. The remaining cells may be left at their default values.

CNDPRICHOR	2L6x6x3/4x3/4	Beam	Round Default	A572-50	Typical
CNDPRIHORZ	2L6x6x3/4x3/4	Beam	Round Default	A572-50	Typical
CNDPRIVERT	2L6x6x3/4x3/4	Beam	Round Default	A572-50	Typical
CNDPRILAT	2L6x6x3/4x3/4	Beam	Round Default	A572-50	Typical
CNDPRIDIAG	SR 5/8	Beam	Round Default	A36	Typical
CNDPRIINNR	SR 5/8	Beam	Round Default	A36	Typical
CNDSECCHOR	SR 5/8	Beam	Round Default	A36	Typical
CNDSECHORZ	SR 5/8	Beam	Round Default	A36	Typical
CNDSECVERT	2L4x4x3/4x3/4	Beam	Round Default	A572-50	Typical
CNDSECLAT	2L4x4x3/4x3/4	Beam	Round Default	A572-50	Typical
CNDSECDIAG	2L4x4x3/4x3/4	Beam	Round Default	A572-50	Typical
CNDSECINNR	2L4x4x3/4x3/4	Beam	Round Default	A572-50	Typical
CNDPEDCHOR	L5X5X5	Beam	Round Default	A36	Typical
CNDPEDHORZ	L5X5X5	Beam	Round Default	A36	Typical
CNDPEDVERT	L5X5X5	Beam	Round Default	A36	Typical
CNDPEDLAT	L5X5X5	Beam	Round Default	A36	Typical
CNDPEDDIAG	HSS5.63X0.375	Beam	Round Default	A572-50	Typical
CNDPEDINNR	HSS5.63X0.375	Beam	Round Default	A572-50	Typical
CNDLEG	HSS5.63X0.375	Beam	Round Default	A572-50	Typical
CNDGUWVERT	HSS5.63X0.375	Beam	Round Default	A572-50	Typical
CNDCRSBRAC	HSS5.63X0.375	Beam	Round Default	A572-50	Typical

- Close the spreadsheet when done.

11. Now we are ready to actually draw the candelabra. Click the  button in RISA-3D and the Graphic Editing Toolbar will be enabled.

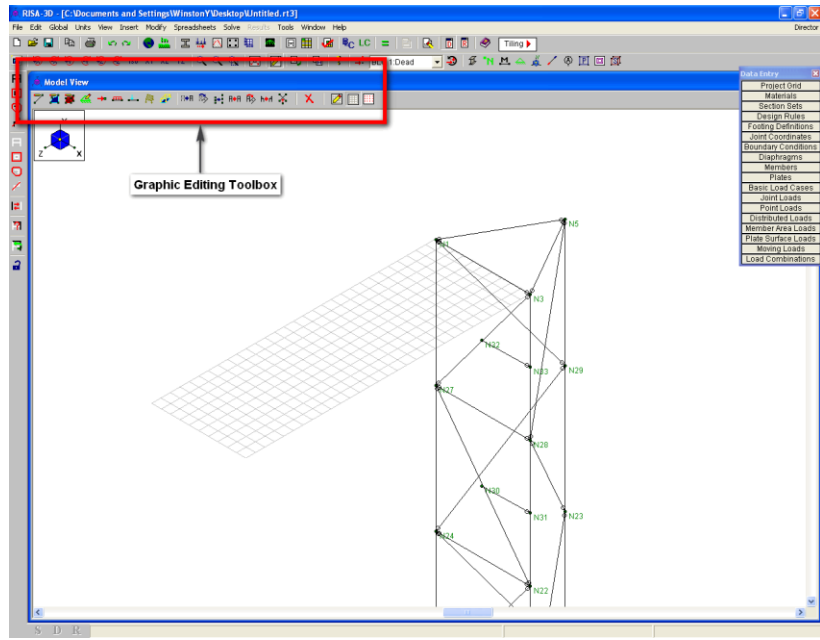

12. Click the  button in the Graphic Editing Toolbar and select *Assign a Section Set* radio button. This is where you choose the section set for the member that you would like to draw. We will start with the Primary Chord so choose “CNDPRICHOR”.

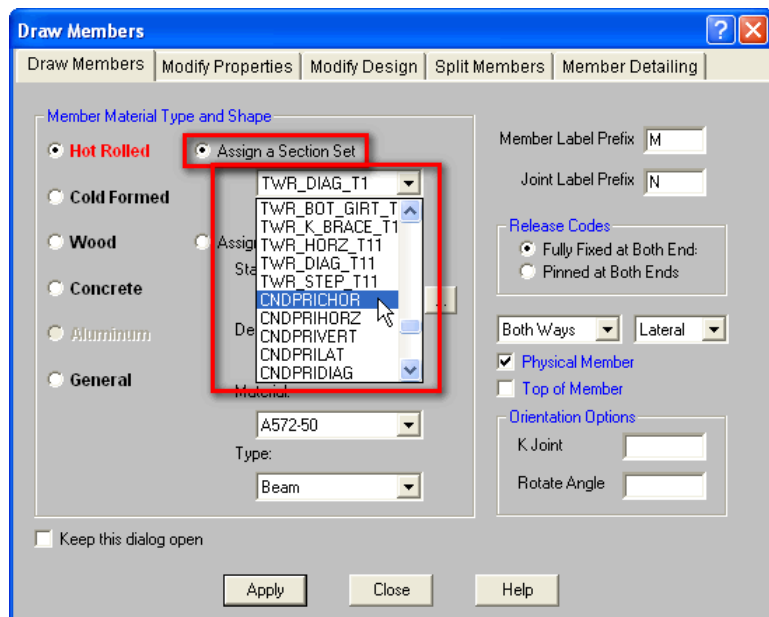

13. The cursor will now look like this , indicating that the program is ready to draw a new member. With the grids present it is easy to draw the members. Note that the cursor snaps to the closest joint or grid when you hover the cursor close to them.
14. The following series of screenshots will illustrate the whole process of drawing the example candelabra. Note that at certain points, the grids will be moved to different locations to assist the drawing of members on other planes.

With the draw cursor  still active, draw the following members. To “lift up” the drawing cursor to draw a member that is not connected to the previous one, right-click once and then continue drawing. Right-click twice when done.

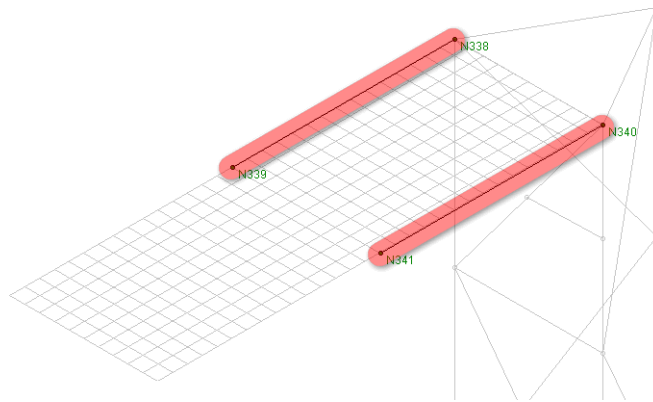

Click  again, select “CNDPRIHORZ”, and draw the following members:

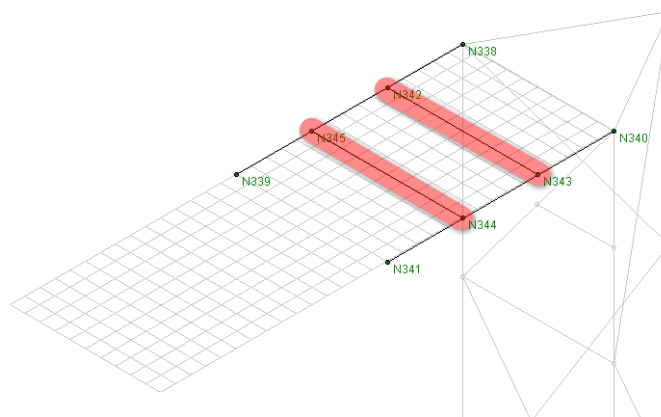

Click  again, select “CNDPRILAT”, and draw the following members:

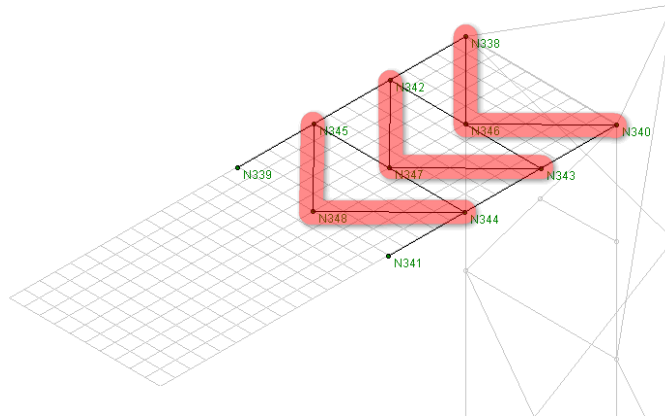

Click  again, select “CNDSECCHOR”, and draw the following members:

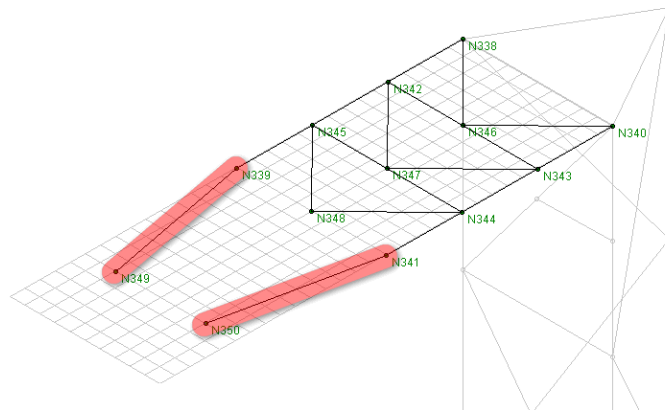

Click  again, select “CNDSECHORZ”, and draw the following members:

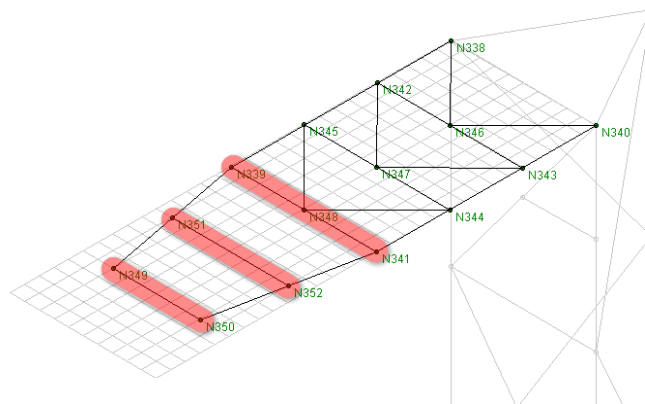

Click  again, select “CNDSECLAT”, and draw the following members:

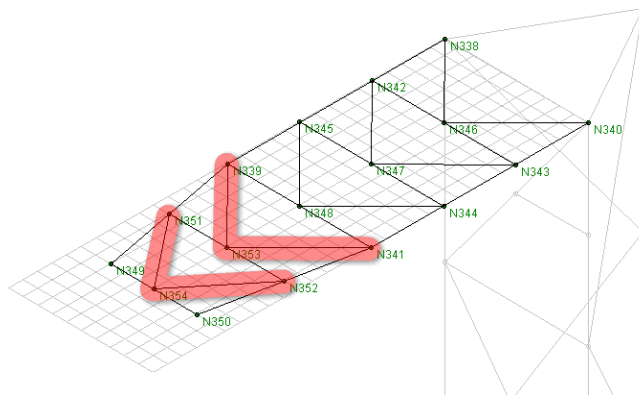

Click  again, select “CNDPEDCHOR”, and draw the following members:

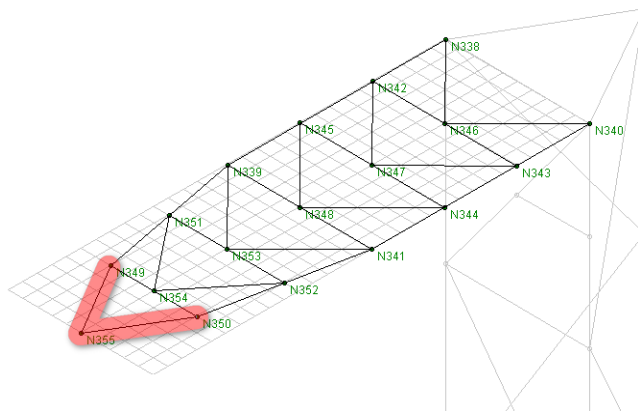

15. We now have to replicate this “top” portion of the candelabra to create the “bottom” portion.

Method A:

Select *Insert* → *Grid* and check the “Click on location to relocate Origin” checkbox and with the “Rectangular Grid Increments” same as before, click OK. Select the following joint as the new origin of the grid:

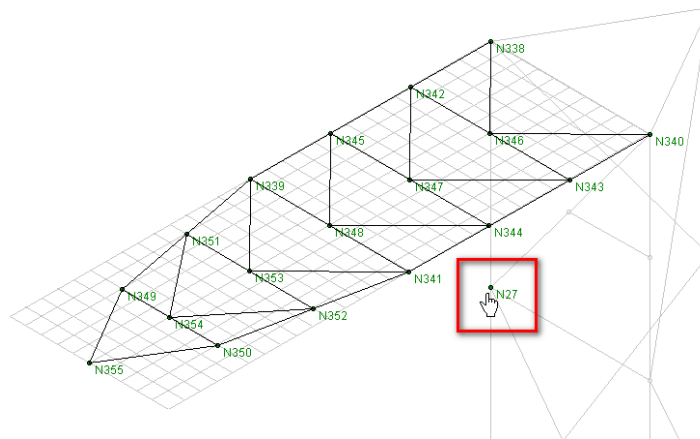

With the grid at the level of the “bottom”, repeat the steps that were used before to draw the top side of the candelabra.

Method B:

Make sure that only the candelabra portion of the structure is selected. If any other members of the tower are selected do the following:

Unselect everything by hitting Ctrl+U. The whole structure including the candelabra will now be drawn with solid grey lines.

Re-select the candelabra members only:

Press the **XZ** and the  buttons to change the view to the XZ plane (birds-eye view, assuming global Y axis is vertical), and place the model in the center of the screen.

Click the  button and enclose candelabra members as shown below:

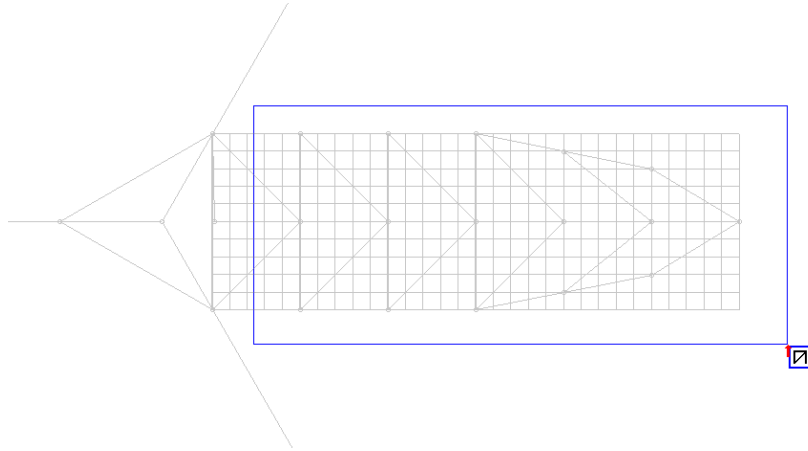

There will be a few more candelabra members that are connected to the tower and are not selected yet. Click the  button and drag a line across the remaining members:

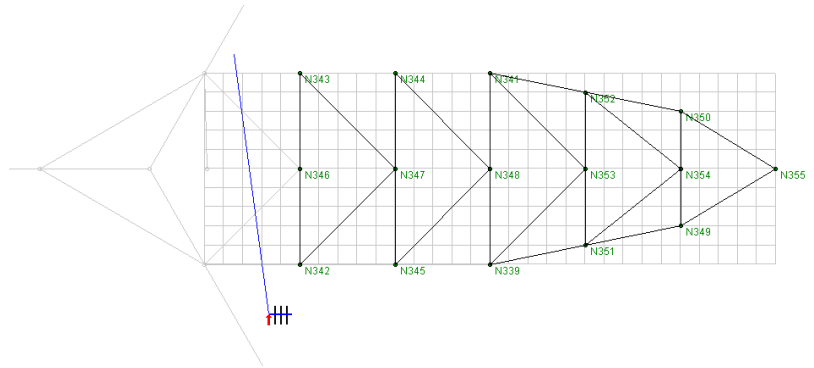

With only the candelabra selected and the rest of the tower unselected, go to *Modify* → *Copy...* in the main menu. In this example the depth of the candelabra is 3'-4", therefore "-3.3333" is entered into the first line of the vertical axis input field (Y-axis input field). This instructs the program to replicate the selected joints and members 3.3333ft below the existing. Click *Apply*.

Click the **Iso** and  buttons and zoom into the candelabra to see the results. The model should now look like this (grid turned off):

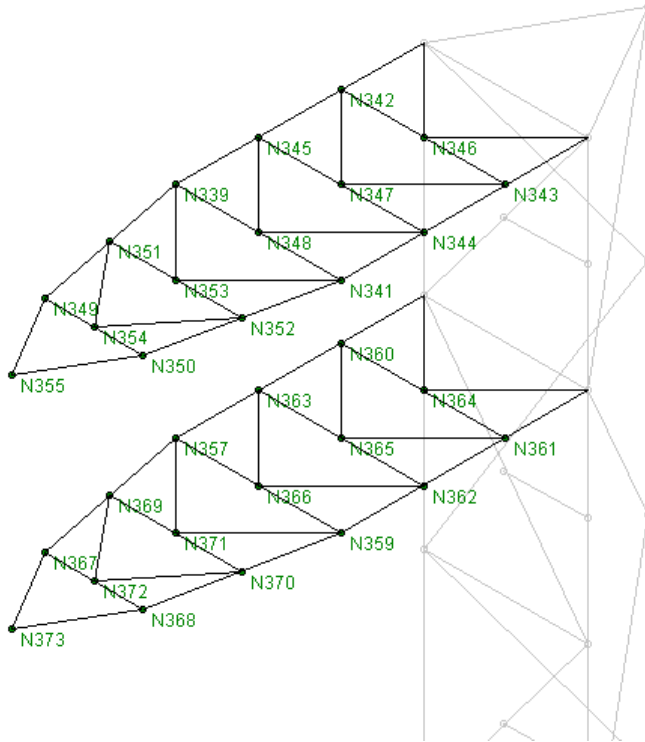



16. Draw the following vertical and diagonal members:

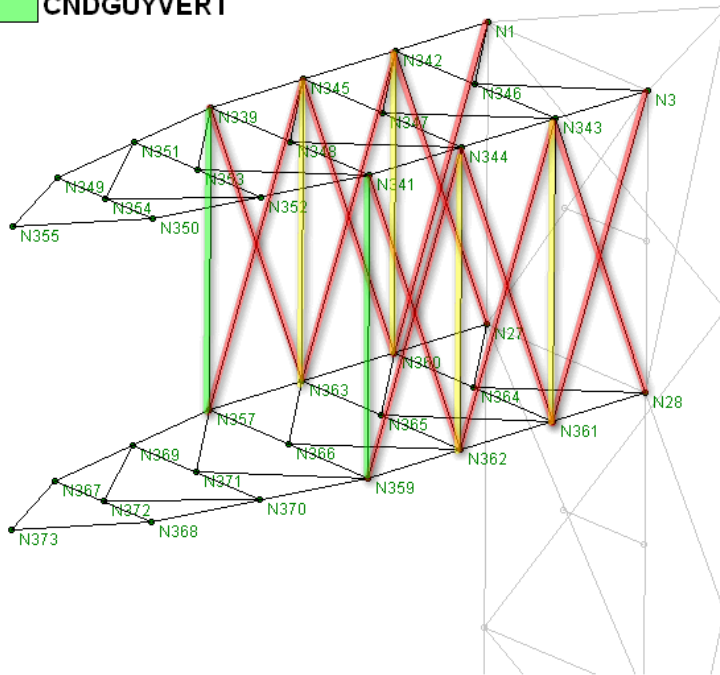

- CNDPRIVERT
- CNDPRIDIAG
- CNDGUYVERT

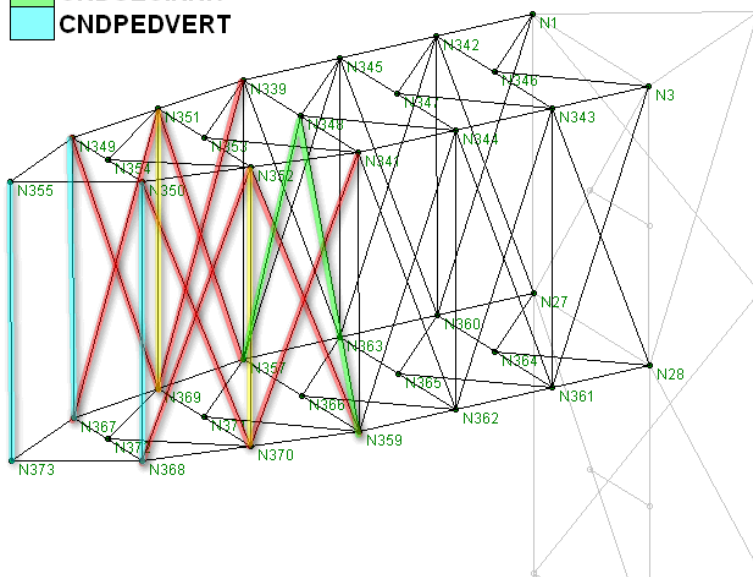

- CNDSECVERT
- CNDSECDIAG
- CNDSECINN
- CNDPEDVERT



17. Click the  button located in the Graphic Editing Toolbar and click the “Snap To Options” tab. Check the boxes for “Quarter Points” and click OK. Your cursor will not only snap to joints now but also to members at quarter point intervals. This enables you to draw the following members by snapping to half-length points of verticals and horizontals:

 **CNDPEDDIAG**
 **CNDPEDINN**
 **CNDPEDHORZ**

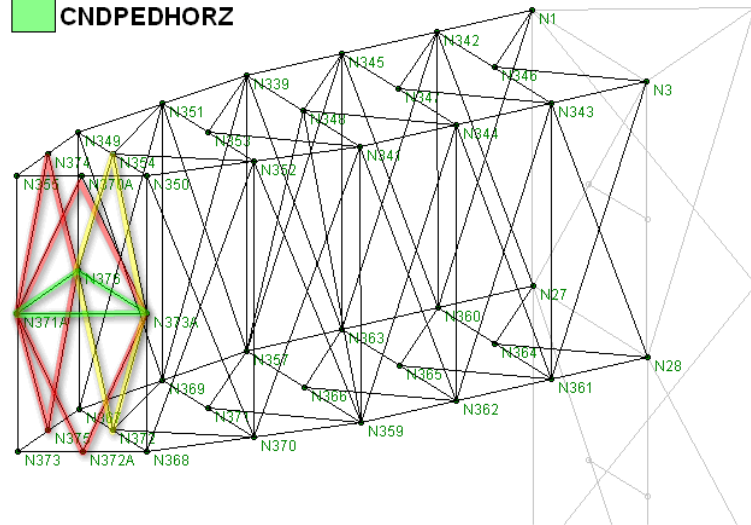

18. Next, draw candelabra legs, as shown below. Candelabra guy cables attach automatically to end nodes of legs. Please refer to section “Attaching Guys to Candelabra” for more information.

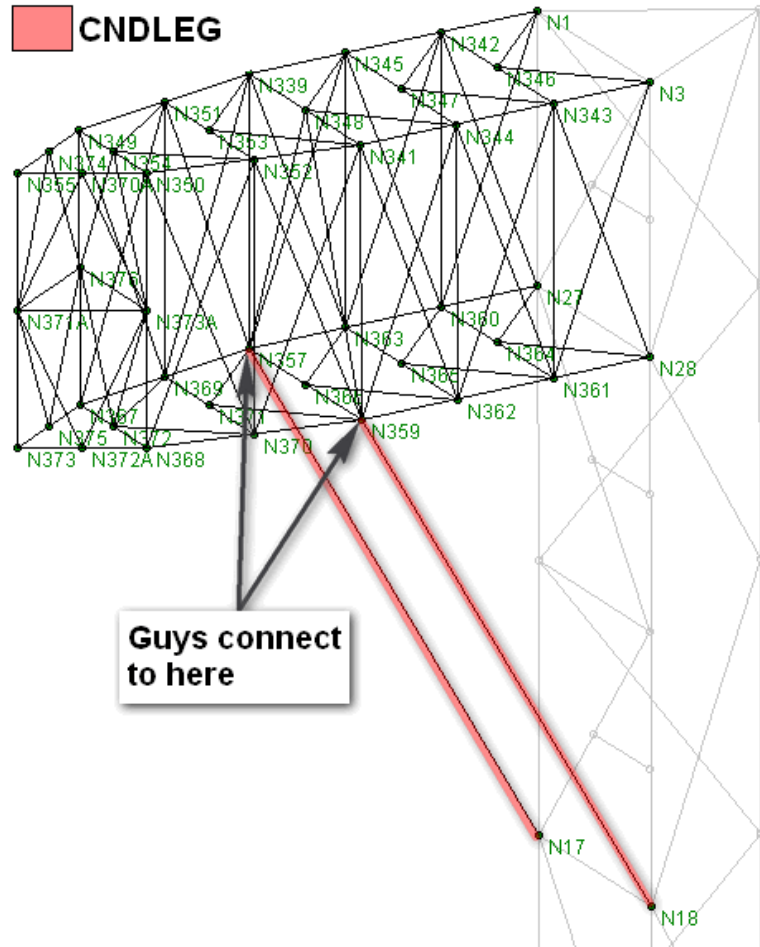

19. This example includes sets of two cross brace members (upper and lower level) spanning between adjacent candelabra arms.

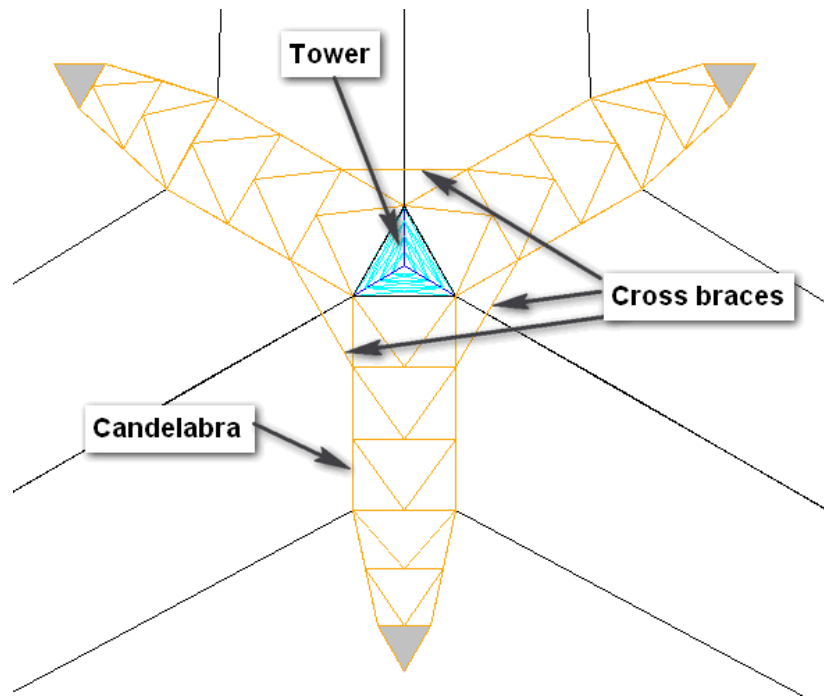

Since we create only one candelabra arm, the braces cannot be modeled connected at both ends. However, because of symmetry, it is sufficient to include in your RISA-3D model only one set of cross braces attached to the appropriate nodes of the modeled arm and leave the other ends unattached {"floating"}.

tnxTower import mechanism inserts cross braces between corresponding nodes on adjacent arms based on that information. For this reason, the length and orientation of the cross braces in your RISA-3D candelabra model do not matter, since they will be re-generated.

The braces may be attached to either side of the arm. The "floating" ends will require joints to temporarily connect to. This may be accomplished by inserting a grid in an arbitrary plane and snapping to any two points on it.

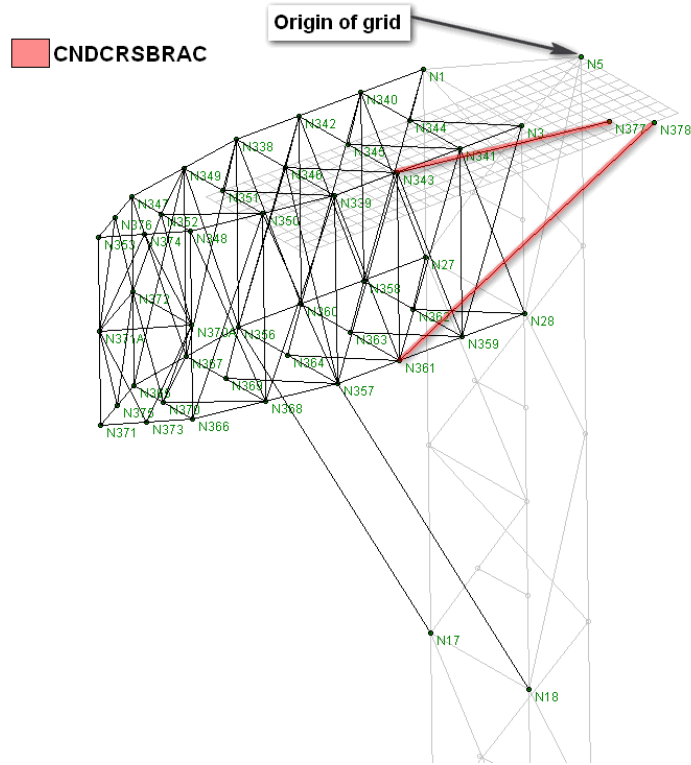

20. The candelabra model is complete now. Save the file (in rt3 format) for importing into tnxTower model later. You may exit RISA-3D.

Method 2: Attached to the horizontal axis

The candelabra arm is so located that the nodes attaching to the base tower are in one of the global vertical planes (XY or YZ, if Y is the vertical axis), and one of the horizontal axes is the axis of symmetry of the arm.

The height at which the model is set up in RISA-3D does not matter, since tnxTower candelabra import function uses the “Height Of Candelabra Platform Top Above Base Of Tower” value entered on the Candelabra input screen.

The possible configurations are as follows:

1. **Attachment nodes in XY plane, facing (+) Z direction:**

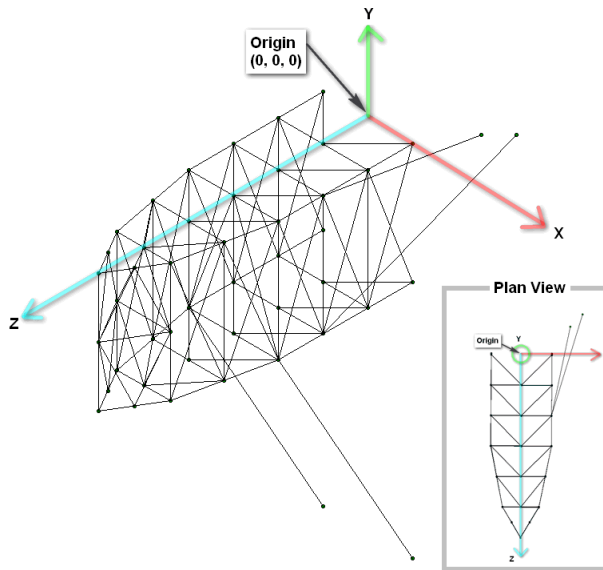

2. **Attachment nodes in YZ plane, facing (+) X direction:**

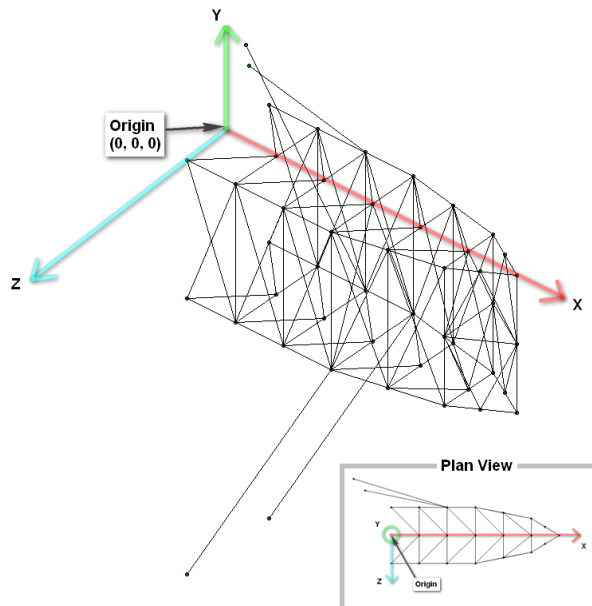

3. **Attachment nodes in XY plane, facing (-) Z direction:**

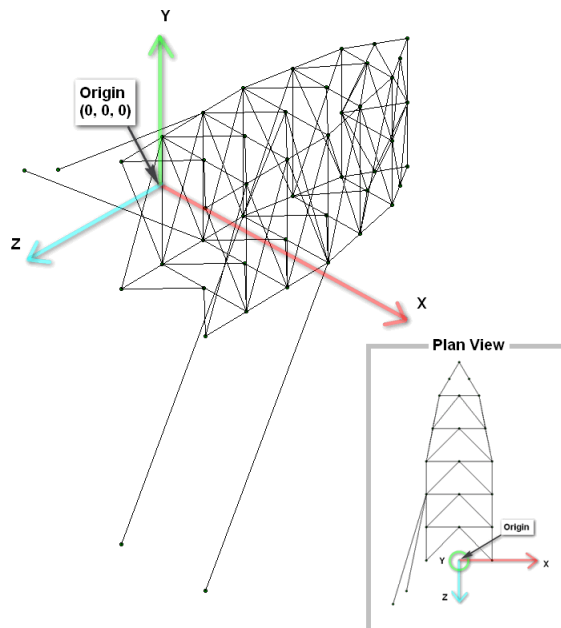

4. **Attachment nodes in YZ plane, facing (-) X direction:**

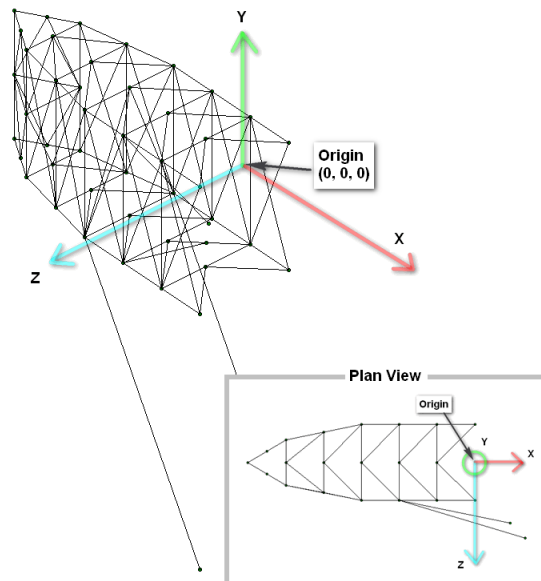

In this method, the candelabra file is generated as a new RISA-3D project – no model export from tnxTower is assumed. This Please refer to RISA-3D documentation for detailed modeling instructions.

Pedestal Definition

Important: Once the candelabra arm is created in RISA-3D, it is necessary to identify the point of application of loads specified on the Candelabra input screen in tnxTower. This is accomplished by defining the candelabra arm's pedestal as a set of master and slave joints. The master joint needs to be located centrally within the area delineated by the pedestal horizontal members and corner slave joints, as shown below:

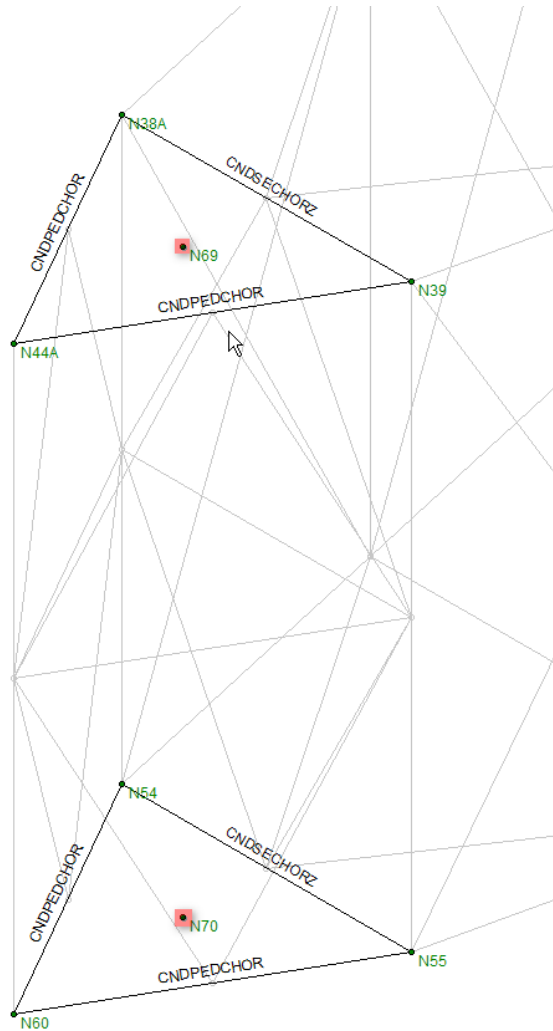

Candelabra forces defined on the Candelabra input page are applied to the top and/or bottom master joints.

Triangular Candelabra

Triangular candelabras are modeled the same way as other candelabras, but there are a few additional items that need to be considered.

The figure below shows an example of a triangular candelabra model in RISA-3D ready for import into tnxTower. This is, as before, one third segment of the actual candelabra structure:

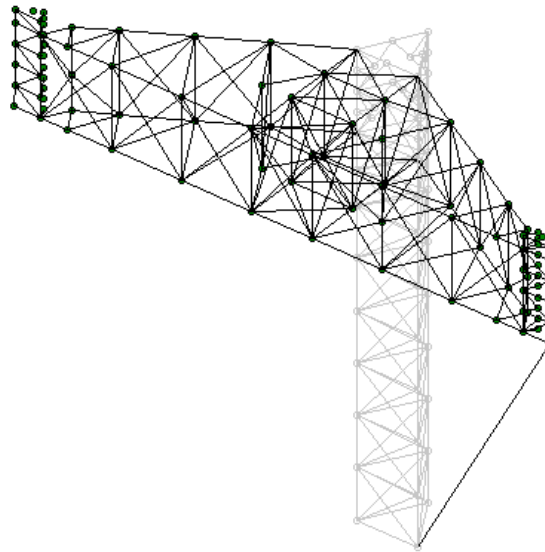

Once the RISA-3D model shown above is imported into tnxTower, the program will generate the balance of the candelabra members:

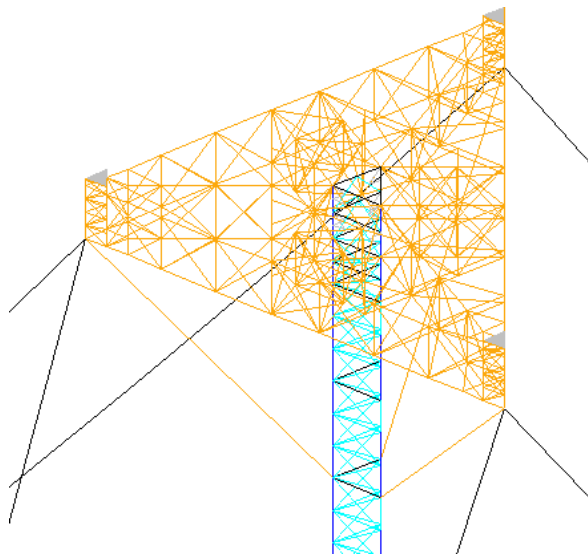

Continuous Members

If a member spans between adjacent segments of the candelabra, in RISA-3D create only half lengths of those members. They should be attached to the

appropriate nodes of the RISA-3D segment and terminated at their mid-points (located on the boundary with the adjacent segment):

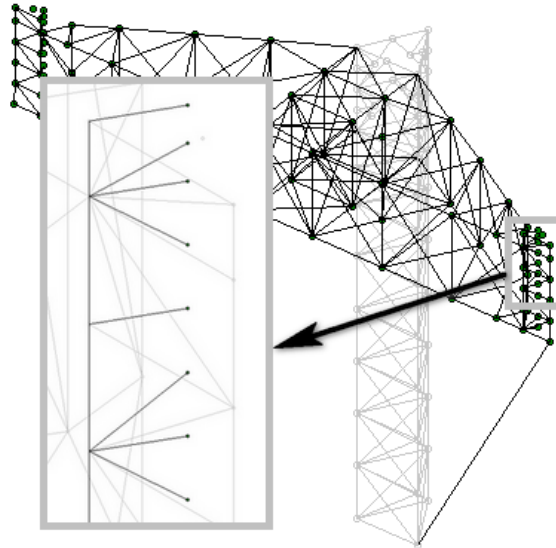

Please note that the candelabra segment that you are modeling will be repeated around the tower. Consequently, the half-length members will also be repeated and joined at their mid-points to form full members.

Pedestal

If a pedestal point in your candelabra is centrally located within an area delineated by members from two segments of your candelabra, place the pedestal point where it would be if all candelabra segments were present. Slave the corner nodes that delineate the pedestal area to this pedestal point.

The figure below shows where the pedestal points are in a RISA-3D model of a triangular candelabra segment:

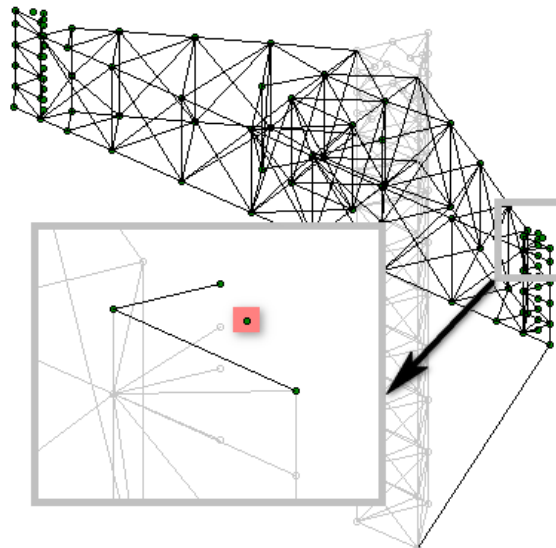

Candelabra Leg

If a candelabra leg is shared between two candelabra segments, create only **one** of the shared candelabra legs and it will be repeated in the tower accordingly.

Candelabra Loads

For regular candelabras, the pedestal points (A, B, or C) are associated with tower faces to which the corresponding arms are attached.

In triangular candelabras, pedestal points are located between faces. The convention that tnxTower uses is that a pedestal point is associated with a face that is located on the clockwise side of the point.

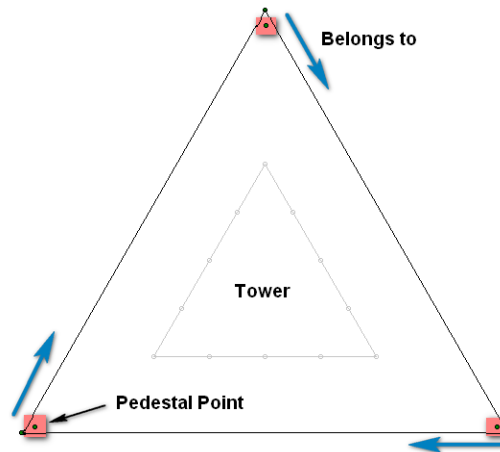

Candelabra Section Sets

Important: Please note that candelabra Section Set Names used must be entered exactly as below. Otherwise tnxTower will not recognize them correctly and the candelabra import will fail.

Type	RISA-3D Section Set Name
Candelabra Leg	CNDLEG
Candelabra Guy Vertical	CNDGUYVERT
Candelabra Cross Brace	CNDCRSBRAC
Primary	
Chord	CNDPRICHOR
Horizontal	CNDPRIHORZ
Vertical	CNDPRIVERT
Lateral	CNDPRILAT
Diagonal	CNDPRIDIAG
Inner	CNDPRIINNR
Secondary	
Chord	CNDSECCHOR
Horizontal	CNDSECHORZ
Vertical	CNDSECVERT
Lateral	CNDSECLAT
Diagonal	CNDSECDIAG
Inner	CNDSECINNR
Pedestal	
Chord	CNDPEDCHOR
Horizontal	CNDPEDHORZ
Vertical	CNDPEDVERT
Lateral	CNDPEDLAT
Diagonal	CNDPEDDIAG
Inner	CNDPEDINNR

Candelabra Section Sets are limited to the following shapes:

Wide Flange

Tube

Pipe

Channel

Angle

Double Angle

Flat Bar

Solid Round

Examples below illustrate use of candelabra Section Sets:

CANDELABRA 1:

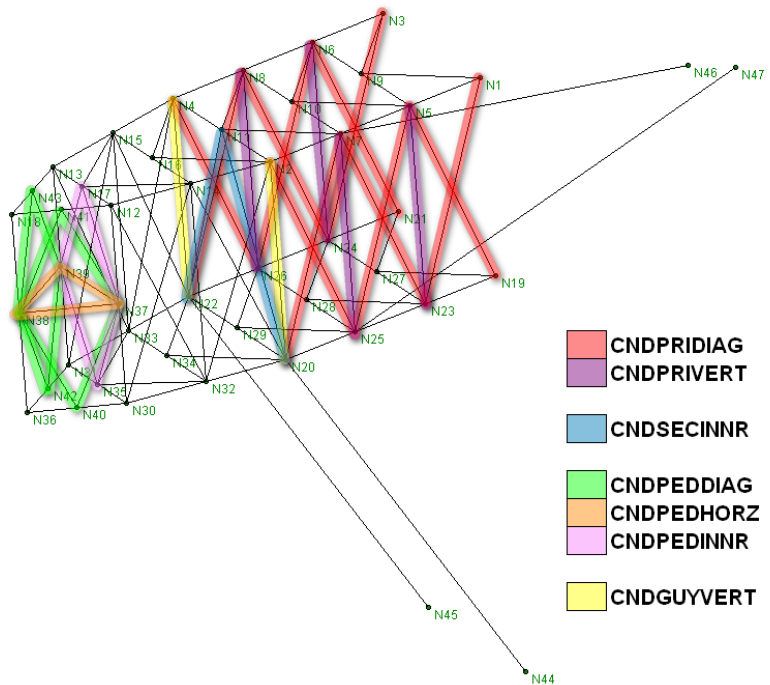
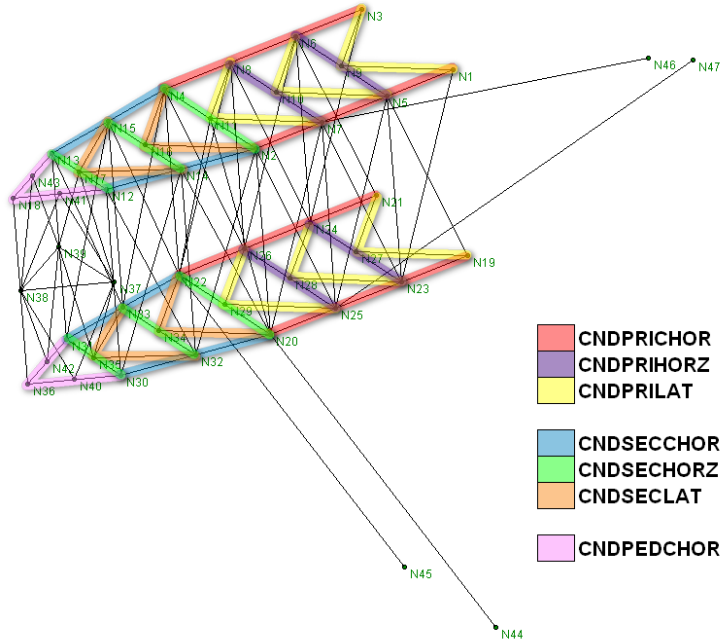

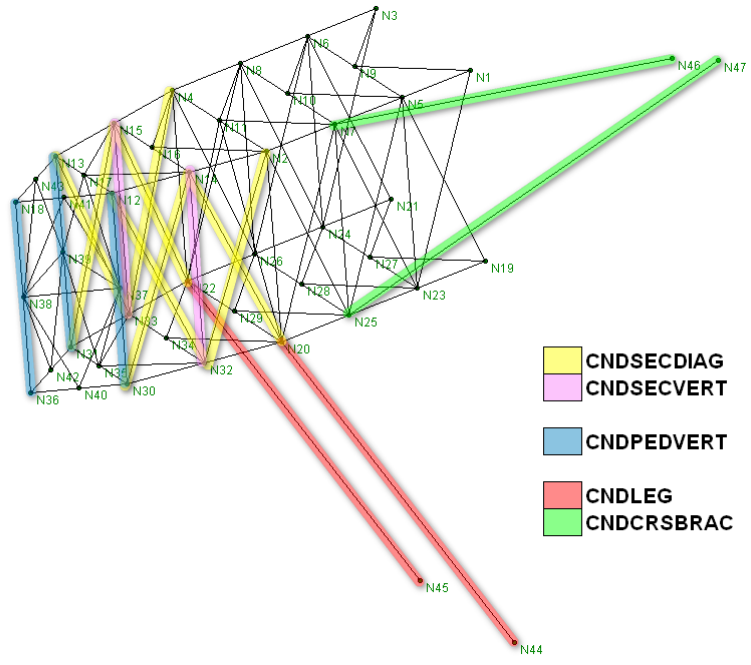

CANDELABRA 2:

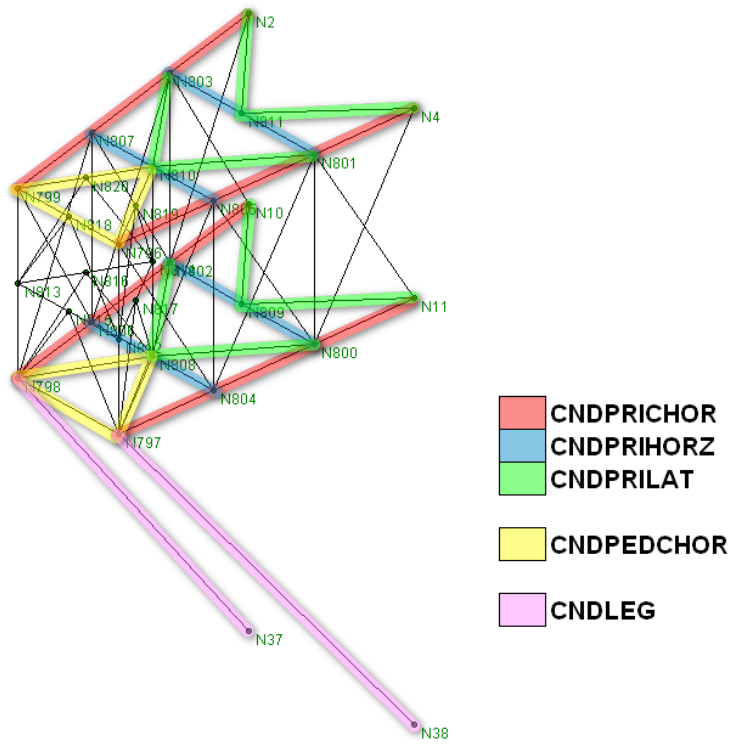

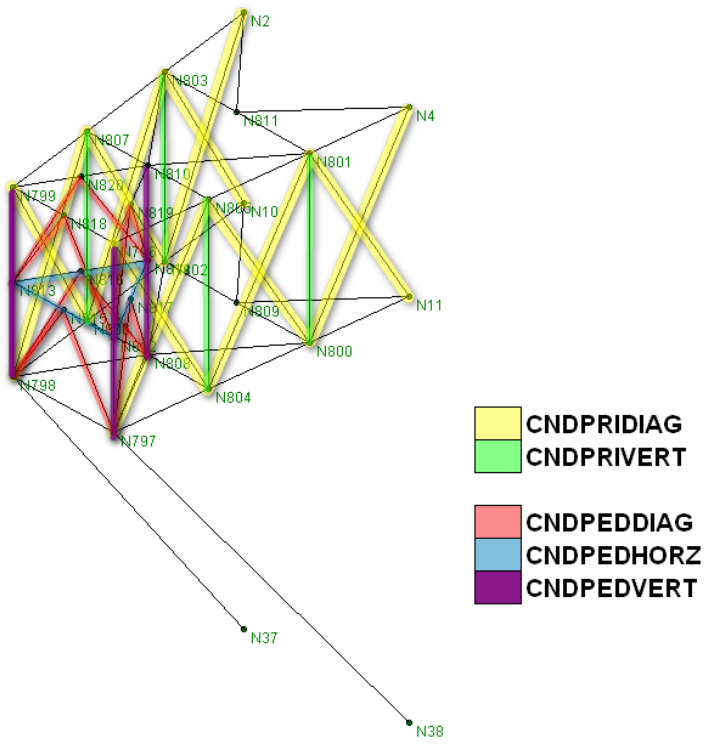

Solution Parameters

The following “Rules of Thumb” are provided for general guidance in selecting solution parameters. When a P-delta solution does not converge, then the structure may be too flexible to come to a stable solution. Check your configuration. When the configuration looks good, you may try to increase the minimum stiffness up to a maximum value of 100.

Solution Parameters General Guidelines			
Self-Supporting Towers (SST)	Linear Analysis	No Special Conditions	
	P-Delta Analysis	Maximum Cycles	200
		Convergence Tolerance	.001
		Minimum Stiffness	0 (monopoles and SST w/o redundant bracing) 25-300 (SST w/redundant bracing)
		Maximum Stiffness	0
		Power Term	0
Guyed Towers (GT)		Maximum Cycles	500
		Convergence Tolerance	.0001 (Ht<=500')
			.00015 (500'>Ht<=1000')
			.0002 (Ht>1000')
		Minimum Stiffness	5 (Ht<=1000')
			10 (Ht>1000')
Maximum Stiffness	3000		
Power Term	3		

Notes:

For guyed towers that fail to converge, double the convergence tolerance and set the minimum stiffness to between 15 and 100. When the tower still fails to converge, and you are using an X-Brace bracing pattern, change the pattern to CX-Brace and adjust your diagonal k-factors to 0.5 on the Advanced page.

For p-delta runs where the “Power Term” is used, do not set the maximum stiffness term to 0 or to a value higher than 10000.

The Maximum Cycles value can be increased up to 10000 for SST and 20000 for GT. In some instances, if the number of cycles is set too low, it may cause the analysis for a load combination to terminate before it can converge.

When a solution does not properly converge (or converges with Parameters outside of appropriate ranges) the reported results (reactions, internal forces, and displacements) are quite unpredictable and are usually incorrect. Spurious values of member forces may consequently produce incorrect member utilization ratios.

We recommend that any analysis run should be free of warning and error messages. These messages, displayed in the solver window at the conclusion of the analysis run, usually signify that the program was unable to obtain reliable results. This may be due to a combination of tower geometry, loading, and Solution Parameters used. You should adjust the Parameters, as appropriate, and continue running analyses until all errors and warnings are eliminated.

The error % values listed in the **Solution Summary** table in the report represent discrepancies between applied forces and reactions. Such discrepancies are expected for non-linear analyses, since external (diminishing) restraints are used to converge the solution. However, you should confirm each time that the differences are in the acceptable ranges.

For a non-linear analysis it is difficult or impossible to reliably extrapolate the discrepancies of internal forces based on error values in the **Solution Summary** table. The internal forces errors may be substantially different from the solution error listed in the table.

In some cases, the analysis cannot converge or produces unusually large displacements due to the loss of structural stability of the tower. This possibility should always be kept in mind when the causes of such outcomes are investigated.

Non-Linear Analysis

For ordinary structures, a non-linear analysis can be accomplished by use of standard Newton-Raphson incremental solution techniques. This technique can be described as follows:

1. Establish local coordinates by use of global displacement $\{D\}$.
2. Compute element deformations and compute element nodal d.o.f. $\{d\}$ in local coordinates.
3. Establish element stiffness $[k]$ and forces $\{r\} = -[k]\{d\}$, both in local coordinates.
4. Transform $[k]$ and $\{r\}$ to global coordinates.
5. Repeat steps 1 thru 4 for all other elements and assemble arrays $[K] = \Sigma[k]$ and $\{R_r\} = \Sigma\{r\}$. Matrix $[K]$ is the complete structure stiffness array in the structure's current configuration.
6. Compute an unbalance of loads $\{\Delta R\}$ as the vector of applied loads plus forces $\{R\}$.
7. Solve the structural equations $[K]\{\Delta D\} = \{\Delta R\}$ for displacement increments $\{\Delta D\}$.
8. Add increments $\{\Delta D\}$ to the global displacements $\{D\}$ accumulated in preceding iterations. This gives the updated estimate of the equilibrium configuration.
9. Test for convergence. When not satisfied, return to step 1.

In structures that contain highly non-linear elements such as cables, the basic Newton-Raphson method may not converge toward a stable solution and either a load increment or under-relaxation approach must be employed. This allows the

structure to slowly approach the correct solution geometry without displacing so much that a solution cannot be achieved.

Under-relaxation can be visualized as inserting artificial springs at each degree of freedom in the system. Such springs remove energy from the system and must therefore be kept small enough so as not to adversely affect the accuracy of the solution. The springs can be gradually reduced during each cycle until they are no longer of any consequence. The spring stiffness that is added during each cycle can be expressed as:

$$K_{spring} = \frac{S_{max}}{i^n} + S_{min}$$

Where:

- S_{max} Maximum stiffness
- S_{min} Minimum residual stiffness
- n Under-relaxation power term

Graphically this can be shown to be:

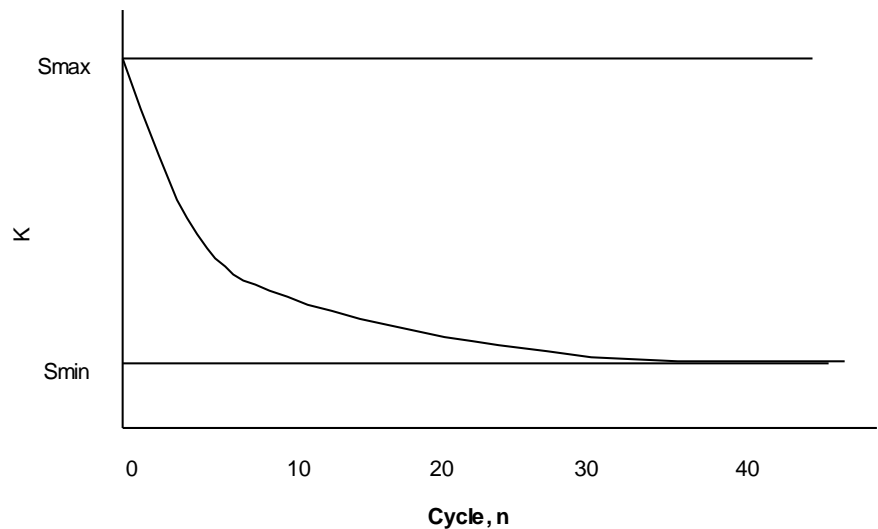

Some Useful Facts

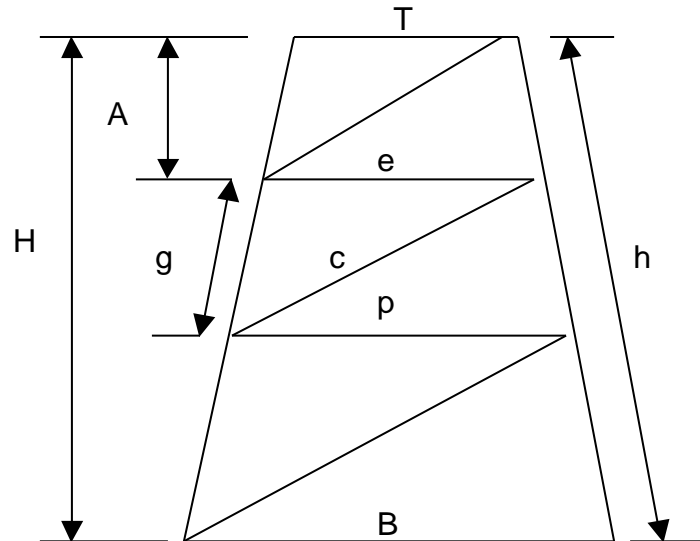

n = number of panels

$$A = \frac{H}{n}$$

$$K = \frac{B - T}{n}$$

$$e = T + K$$

$$p = T + K \times 2 \dots etc.$$

Three Sided Tower Equations

$$h = \sqrt{H^2 + \frac{(B - T)^2}{3}}$$

$$g = \frac{h}{n}$$

$$c = \frac{1}{2} \sqrt{(e + p)^2 + 4A^2 + \frac{K^2}{3}}$$

Four Sided Tower Equations

$$h = \sqrt{H^2 + \frac{(B - T)^2}{2}}$$

$$g = \frac{h}{n}$$

$$c = \frac{1}{2} \sqrt{(e + p)^2 + 4A^2 + K^2}$$

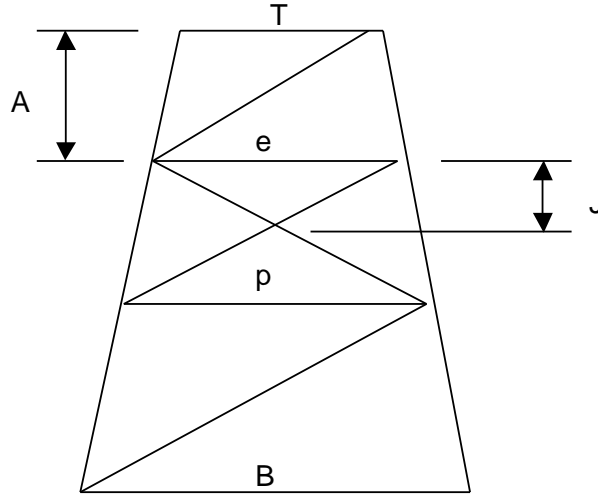

$$J = A \times \frac{e}{(e + p)}$$

Modeler Rules

Member Hierarchy

The model follows the following generation hierarchy:

- Girts supersede any horizontal that was generated.
- Guy pull offs supersede any girt or horizontal that was generated.
- Guy diagonals supersede any diagonal that was generated.

Special Note About K-Brace Downs

When the top most section has only a single K-brace down panel, both the horizontal member and the girt size must be entered, but the girt will be used due to the member hierarchy rules. In single panel sections where the girt size is left blank, the horizontal size will be used.

Angle of Roll

The program will automatically calculate the "angle of roll" or gamma rotation such that members will be properly oriented.

For members that are symmetric, such as pipe, solid round or truss-legs, the angle of roll is left as 0.

All other types are oriented as follows:

- Leg members have their principal axes oriented point at the centroid of the tower.
- Horizontal and diagonal members are oriented such that their vertical plane is the same as the plane of the face of the tower.

- Single angle members are rolled an additional 180 degrees such that the vertical leg (which normally points vertically with 0 roll) will point downward, as is the usual practice in tower design. This allows rx and ry to remain as intended.

Wind Area

The wind area of members is established using the vertical height of each type of member section.

Angle Designations

Single, double, and quad angle sections are referenced by their vertical leg first, and then the horizontal leg. For double and quad angles, a third parameter, the back-to-back dimension, is used. Double and quad angles without a back-to-back dimension will be exempt from the stitch bolt spacing reduction in equivalent kl/r required by the TIA standard.

Determining Pcrit For Tower Sections

To properly check mast stability, the program uses the following rules:

- For guyed towers, Lu is the distance between guys with a K factor of 1.0. The program determines a value for Pcrit based upon the KL and I of the entire mast section. The moment of inertia of the tower is taken as .95 times the actual moment of inertia to account for shear effects.
- For free-standing main towers, mast stability is not checked.
- For towers with upper latticed poles, Lu is the distance from the top of the main tower to the top of the upper tower. K is specified by the user and is usually between 1 and 2. When a p-delta analysis is used, a lower value may be considered. The program determines a value for Pcrit based upon the KL/r of the entire mast section or the individual leg section, whichever is greater.

Monopoles

For ground-mounted poles, the TIA Standard ignores buckling and therefore K can be set to 0 and mast stability turned off. To run a monopole to strict TIA standard methods, turn off the Include Shear-Torsion Interaction and the Mast Stability criteria and set the mast stability K factor to 0. This will enforce the TIA criterion that $F_a = F_b$ due to local buckling only. The TIA Standard requires a P-Delta analysis for all monopoles, the logic being that if the P-Delta analysis does not converge, the pole has buckled.

The program will calculate the section modulus, I/c and user the square root of the sum of the squares of Mx, Mz to determine the bending stress..

Orientation of Members

The default orientation of members and their local axes is as shown in the AISC Manual of Steel Construction.

For leg members the following rules apply:

- Single angles, 60 bent plate angles, and 60 degree (Schifflerized) angles, the member is orientated so that the principal axis through the heel of the angle is along a line extending from the centroid of the tower.
- Solid rounds and pipes are not subject to any modification since they are symmetrical.
- All other shapes are orientated so that their local y-axis points outward along a line extending from the centroid of the tower.

For all other members (diagonals, horizontals, girts, etc.), their local y-axes are oriented in the plane of the face of the tower. Single angle members are additionally rotated 180 degrees so that the vertical leg points downward along the plane of the face.

How Top and Bottom Girts Are Generated

When a section has a bottom girt and the section below it has a top girt, both girts are modeled with an offset distance as entered by the user.

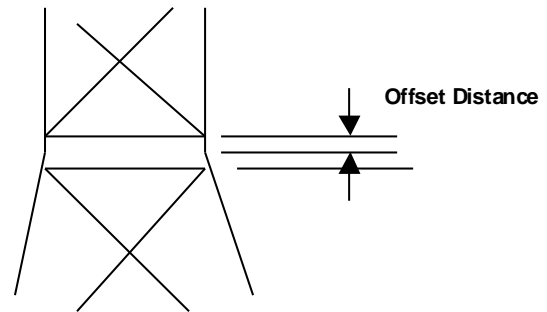

When a section has a bottom girt and the section below it does not have a girt, then the girt is modeled without any offset.

At the very top of the tower and the base of the tower, the girt is modeled without any offset.

Feed line Stacking

When feed lines are stacked or bundled, and the lines are treated as structural elements, A_r or A_f , then the projection of the area can be accomplished in one of two ways.

The first approach is the classical approach that many designers have assumed in that the feed line area, like other structural areas, is projected on to the face of the tower regardless of the direction of wind. Since the lines are stacked one above the other, only one row is exposed to the wind (TIA 222-F definition of A_r and A_f , Section 2.3.5.1).

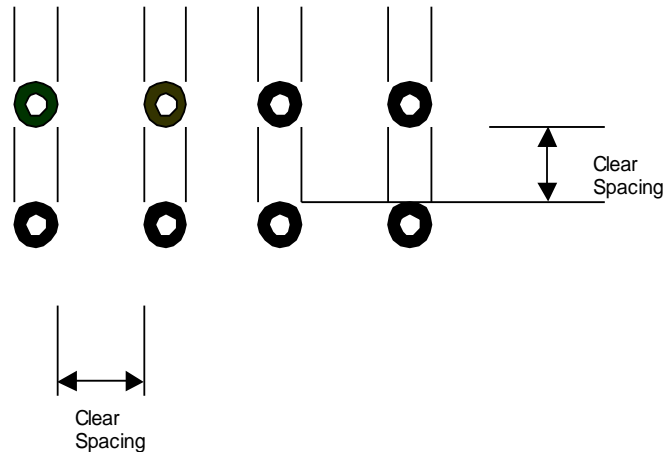

Projection On To The Face Projected width is 4 x dia

Many other designers believe that the straight projection method is not conservative enough since wind striking the bundle at an angle will tend to see a solid mass of coax. In this method the projected width is the lesser of the sum of the individual widths of all the lines or a circle that encompasses the entire bundle. The encompassing circle will not control if the lines are widely spaced in which event the width is the sum of the diameters of the individual lines will control.

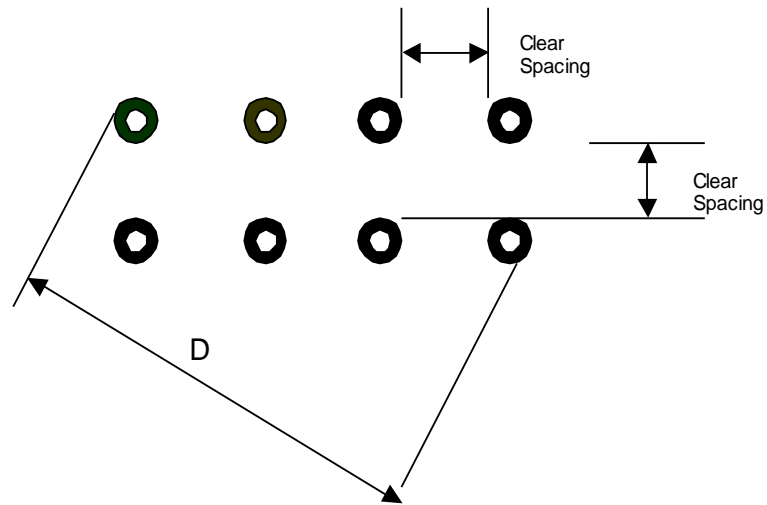

Encompassing Cylinder
 Projected width is lesser of 8 x dia or D

In the above examples, if a 20' of coax with diameter of 2" is stacked with a clear spacing is 1", the projected area method will result in an area of $4 \times 2 \times 240 / 144 = 13.333$ square feet while the encompassing cylinder method will result in $8 \times 2 \times 240 / 144 = 26.666$ but not greater than $11.487 \times 240 / 144 = 19.144$ square feet. The encompassing cylinder method results in a 43.5% increase in structural area, A_r , compared to the straight projection method.

When ice completely closes the clear space between lines, then the area is treated as a flat (A_f) with one line are of round (A_r).

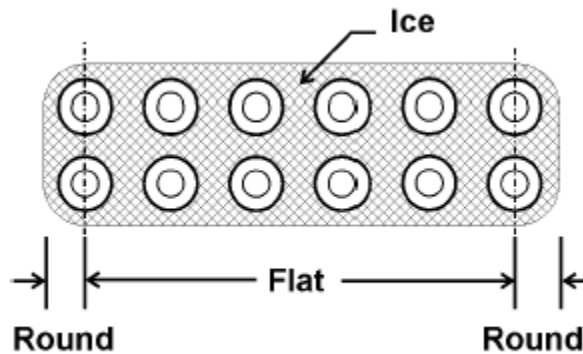

Projection of Discrete Appurtenance Areas

When wind projection is enabled, the program will determine normal and tangential wind forces acting on the front and side areas. When the front and sides are equal, the projection will be equivalent to a round object (all projections being equal).

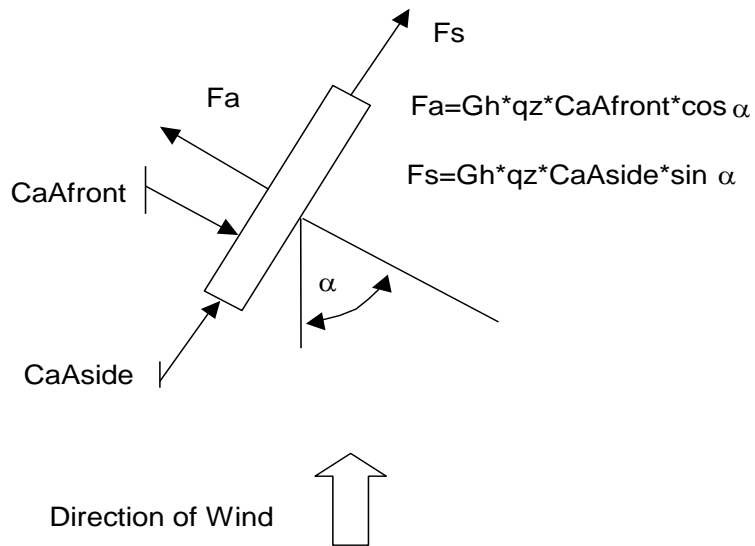

The values of F_a and F_s are then transformed into the global X and Z axes of the tower structure.

$$F_Z = G_H \times q_Z \times (C_A A_{front} \times \cos^2 \alpha + C_A A_{side} \times \sin^2 \alpha)$$

$$F_X = G_H \times q_Z \times (C_A A_{side} - C_A A_{front}) \times \cos \alpha \times \sin \alpha$$

The equation for F_Z is remarkably similar to equation 2.5-9 in the ASCE publication "Guidelines for Transmission Line Structural Loading" used by the transmission tower industry. That equation is:

$$F = .00256 \times G_t \times V^2 \times (1 + 0.2 \times \sin^2 2\alpha) \times (C_{ft} A_{ml} \times \cos^2 \alpha + C_{ft} A_{mt} \times \sin^2 \alpha)$$

Impact of monopole feed line and IPA settings on Cf and total EPA of attachments (TIA-222-G).

The calculation of wind forces on monopoles with attachments such as feed lines, step bolts, brackets, etc. is based on the provisions of Table 2-7 of the Standard. It is assumed in the program that for any specific wind direction only attachments located outside of the contour of the pole attract wind loading (i.e., lines on the wind- and leeward sides of the shaft that are entirely within the width of the pole are excluded, except for their weight).

The value of C_f depends on the ratio (Ra) of the projected area (PA) of attachments located outside of the contour of the pole to the PA of the pole without the attachments. The following input categories are available for specifying the PA:

Advanced tab

Flat/Round IPA on Poles Ratio This area is assumed to be exposed to the wind for all wind directions. The wind force produces no torque about the vertical pole axis.

Feed Lines tab

CaAa (Out Of Face) The entire area entered is exposed to the wind, for all wind directions, regardless of its location on the pole (i.e., coax that lies within the contour of the pole is exposed). The wind force on the lines produces torque about the vertical pole axis. The PA is obtained by dividing the CaAa value by 1.2.

Surface Ar/Af (CaAa) Only lines that are outside of the contours of the pole are assumed exposed to the wind. For different wind directions different lines are outside the pole shadow, thus the projected area of the lines is generally dependent on the wind azimuth.

Cluster Treatment:

Individual Lines All line area that is on the outside of the pole contour for a given wind direction is considered. It may include lines that are shielded by lines in front of them. This specification is suitable for those situations where the actual line placement is uncertain or highly irregular.

Side Projected Area Only the specified number of rows (layers) of coax is considered as the side area of the feed line group. The width of the group is equal to the distance from the pole surface to the outside of the outer layer of the coax. This treatment assumes that the feed lines are a solid block and it therefore includes the width of air spaces between the lines, if any.

All categories of PA above are considered in the determination of the Ra. The Ra is calculated as a sum of ratios (IPA ratios entered plus feed line PA to pole

PA ratios), and consequently have an impact on the Cf of the pole, as per the relevant provisions of Table 2-7. The following rules governing the Cf values and treatment of the additional PAs are implemented:

If Ra <= 0.1:

Cf	no impact
Flat/Round IPA on Poles	ignored (area excluded from consideration)
Surface Ar/Af	ignored
CaAa(Out Of Face)	applied

If 0.1 < Ra <= 0.2

Cf	multiplied by $1.0+3(Ra-0.1)$
Flat/Round IPA on Poles	ignored
Surface Ar/Af	ignored
CaAa(Out Of Face)	applied

If Ra > 0.2

Cf	= 1.2
Flat/Round IPA on Poles	applied (Ca = 2.0 and 1.2 for flat, round, respectively)
Surface Ar/Af	applied
CaAa(Out Of Face)	applied

Please note that the CaAa(Out Of Face) lines are not ignored for any value of Ra. This has been done to preserve backward compatibility with older model files as well as to give the designer an option of specifying lines to which the rules of Table 2-7 may not be applicable.

The Ra value depends on the wind azimuth, as the visible line configuration is also azimuth-dependent. Consequently, the Cf may be different for different wind directions. Also, the additional PA may be ignored for some wind directions and not for others.

The Cf reported in the output is for the specified “Wind nnn To Face” direction for each sector (0, 120, 240 deg for 3-sector poles, and 0, 90, 180, 270 deg for 4-sector poles).

How the Modeler Calculates the Guy Anchor Location

The guy azimuth adjustment angle is normally referred about the centroid of the tower. In certain situations, such as corner mounting or torque-arm corner mounting, the angle is referred to the guy attachment point. The location of the guy anchor is then located as follows.

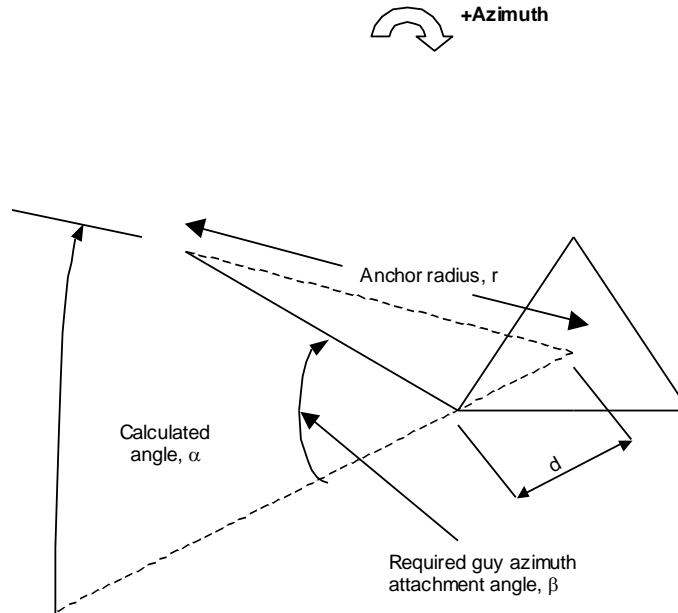

$$\alpha = \beta - \sin^{-1}\left(\frac{\sin(180 - \beta) \times d}{r}\right)$$

How K-Factors Are Applied

Diagonal Members

Diagonal members are best illustrated when used in redundant bracing schemes, such as K3 down. K_x is always applied to the segment length of the member (length between redundant horizontals or between the end of the member and the redundant horizontal).

For redundant bracing schemes, K_y is applied to the unsupported length of the diagonal. tnxTower enforces the triangulation requirements for the hip members, and bracing that is not triangulated is considered ineffective. Consequently, the out-of-plane unsupported length of the diagonals is reduced only if the hip bracing is triangulated.

For X-braced schemes, K_x and K_y are both applied to the segment length (the distance from the leg to the cross-over point). When you wish to observe the old-style ASCE (EIA-222 Table 4) rules for multiple span angles, $L1+.5L2$, then a value of 1.5 would be entered for K about both axes.

K-Brace Horizontals

Since the KL is usually applied to the distance between centers of bolted connection groups, an adjusted value of K to account for connection distance can also be considered such that the correct KL is a result.

K_x is always applied to the segment length of the member (length between diagonal and the leg).

K_y is more complex. When the user enters inner bracing, the K_y is applied to the same length as K_x . When inner bracing is not present then the user-supplied value of K_y is multiplied times two (2) such that the KL would be the entire leg-to-leg dimension.

As an example, if inner bracing was not entered and you wanted to have out-of-plane bracing at the quarter points, enter a value of $K_y=.25$ ($.25 \times 2 = .5$ times the segment length). When inner bracing had been entered and you wanted to have out-of-plane bracing at the quarter point, then enter a value of $K_y=.5$ (no multiplier, the .5 is applied directly to the segment length).

Since the KL is usually applied to the distance between centers of bolted connection groups, an adjusted value of K to account for connection distance can also be considered such that the correct KL is a result.

Auto-Calculation of K-Factors

Solid Round Members

When the option to automatically calculate K-factors for solid round members is chosen, the K values are calculated as shown in the table below (Table 4-5, TIA-222-G and TIA-222-H).

Member Type	Eccentricity	$L/r < 80$	$80 \leq L/r \leq 120$	$L/r > 120$
Single bracing	Cut member	$K = 1.0$	$K = 0.7 + \frac{0.3}{40} \left(120 - \frac{L}{r}\right)$	$K = 0.70$
	Bent member	$K = 1.1$	$K = 0.7 + \frac{0.4}{40} \left(120 - \frac{L}{r}\right)$	$K = 0.80$
Cross bracing	Rods cut & concentric, positioned on their center intersection (& welded)	$K = 1.0$	$K = 0.75 + \frac{0.25}{40} \left(120 - \frac{L}{r}\right)$	$K = 0.75$
	Rods laid over & welded at center intersection	$K = 1.1$	$K = 0.9 + \frac{0.2}{40} \left(120 - \frac{L}{r}\right)$	$K = 0.90$

The length, L, used to calculate L/r is taken as being the elements segment length (i.e. length of x-bracing from leg to cross-over point). When you had supplied a value for K_x or K_y to account for sub-bracing, then the L value is K_x x L and K_y x L. The resulting K value is then multiplied by the user supplied value of K to come up with an appropriate value. When the user supplied K is set to 1, then the resulting calculated value of K is used directly.

tnxTower always assumes that cross bracing (X-bracing) is laid over. CX-bracing and K-bracing end braces are treated as bent single bracing.

Single Angle Members

When the option to automatically calculate K-factors for single angle members is chosen, the K values are calculated using the six curves as found in Table 4 of the TIA-222-F standard (taken from the ASCE 10 standard). Double angles, about their x-axis, will also have K values calculated in this manner.

The ends of the angle are considered partially restrained when the number of bolts is greater than one (1). Intermediate points, for angles that have more than one segments such as X-bracing or K-bracing, are considered unrestrained. When the member has the number of bolts set to zero (0) and the net width deduct set to zero (0), then the member is considered to be welded and partially restrained.

Members are always considered eccentric at the ends of the members. X-bracing is considered concentric at the mid-point where the member is continuous.

Slenderness	Condition	K
$L/r < 120$	Concentric both ends	$K = 1.0$
	Eccentric one end	$K = .75 + \frac{30}{(L/r)}$
	Eccentric both ends	$K = .50 + \frac{60}{(L/r)}$

L/r >= 120	No end restraint	$K = 1.0$
	Partial restraint one end	$K = .762 + \frac{28.6}{(L/r)}$
	Partial restraint both ends	$K = .615 + \frac{46.2}{(L/r)}$

The length, L, used to calculate L/r is taken as being the elements segment length (i.e. length of x-bracing from leg to cross-over point). When you had supplied a value for K_x or K_y to account for sub-bracing, then the L value is K_x x L and K_y x L. The resulting K value is then multiplied by the user supplied value of K to come up with an appropriate value. When the user supplied K is set to 1, then the resulting calculated value of K is used directly.

Additionally, if you have specified a bolt size and number of bolts, then the length is adjusted at each end as shown below:

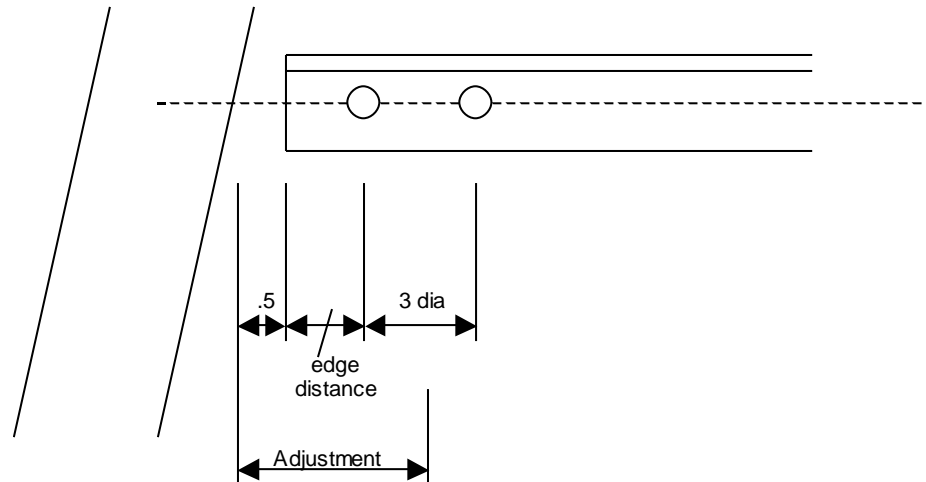

When L/r is less than 120, the resulting K factor will be greater than 1.0. When the L/r is greater than 120, the resulting K factor will be less than 1.0.

Leg Connections

Legs in towers are usually spliced in the following two methods:

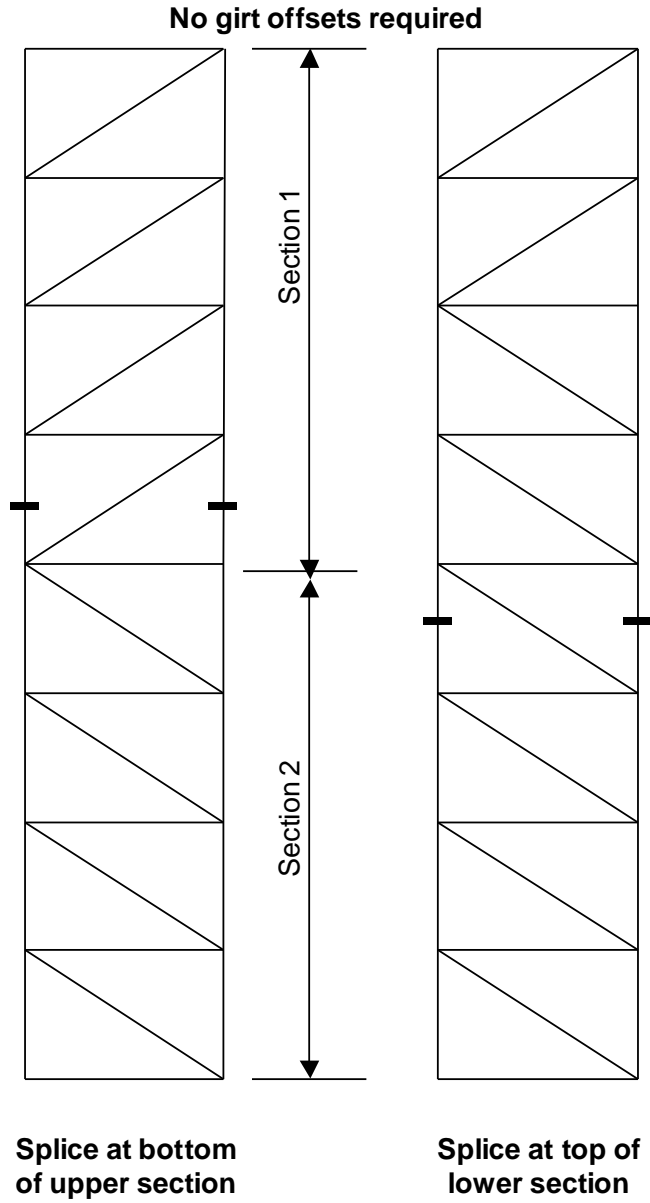

Method 1
Splices Occur At Mid-Panel

Girt offsets required

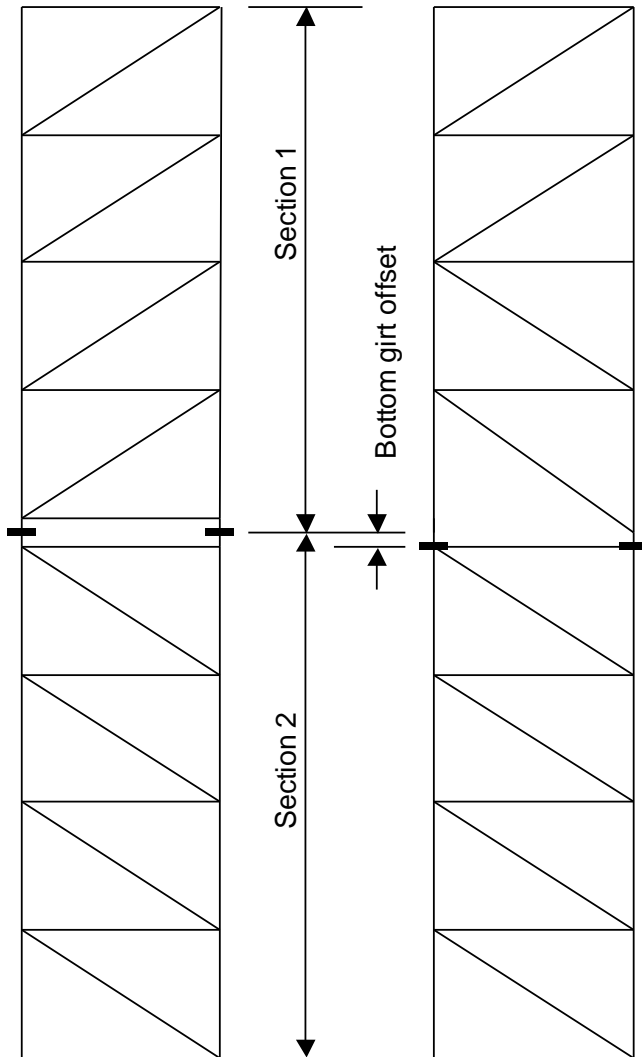

Splice with top and bottom girts - offset defaults if not specified

**Splice without girts - user must specify an offset
Bolts at bottom of section**

Method 2 Splices Occur At End Of Panel

The following rules for properly determining leg bolt splice forces apply:

- At a splice point, if there is a bottom girt from the section above and a top girt from the section below (double girt), the splice is assumed to occur between the two girts. When the girt offsets are left as 0 initially, the default girt offset will be applied to both; otherwise the girt offset you specify will be used. The leg force used will be at the top or bottom of the section

depending on how the user checked the Leg Bolts Are at Top of Section option.

- Typical self-supporting towers do not have double girts but have the leg spliced at mid-panel. Girt offsets should be left as 0 in this case. The splice will be assumed in the top most leg panel if the user checked the Leg Bolts Are at Top of Section option; otherwise it will be assumed to occur in the bottom leg panel.
- Non-typical towers that have a splice in between the end diagonals of mating sections, but have either one or no horizontal members, **must** have an offset specified so that one of the diagonals is moved to make room for the leg connection. When the user checked the Leg Bolts Are at Top of Section option, then the top girt offset should be entered, otherwise the bottom girt offset should be specified. When the offset is left as 0, the splice will be assumed to occur in the first leg panel as described above.

Solid round legs with sleeve connections (PiRod sleeves)

If a sleeve connection is specified for solid round legs, tnxTower assumes that the connection is a PiRod sleeve. PiRod sleeves are welded to the legs of the section above and attached with through bolts to legs of the section below.

The assumed location of leg bolts specified on the Advanced page for this connection type depends on the **Leg Bolts Are At Top Of Section** setting on the Options page:

- **Unselected:** Bolts are at the bottom of the tower section, and connect the sleeve of the current section to the leg of the section below. The net area of the leg below is included in the calculation of the tensile strength of the leg of the current section, and, if controls, reported for the current section. This is usually the optimal settings as it correctly pairs the leg force and leg net area.
- **Selected:** Bolts are at the top of the tower section and connect the leg of the current section to the sleeve of the section above. Since the leg bolt holes are assumed in the current section, the reported tensile strength is based on the gross and net areas of the leg in the current section only.

Design of Grouted Pipe

The design of grouted pipe is based upon the publication "A Specification for the Design of Steel-Concrete Composite Columns" by Task Group 20 of the Structural Stability Research Council published in the AISC Engineering Journal, Fourth Quarter, 1979 and upon the AISC Third Edition LRFD Specification.

Basically the technique uses a modified F_y and E for compression design. For bending, a value of $.75F_y$ on the steel section only is used (ASD). The radius of gyration is also based upon the steel section acting alone. The modifications are as follows:

$$F_{my} = F_y + 0.85 f'_c \frac{A_c}{A_s}$$

$$E_m = 29000 + 0.4 E_c \frac{A_c}{A_s}$$

Mast Stability Index

Calculation of Combined Stress Ratios in Latticed Masts

The standard beam-column formula for stress:

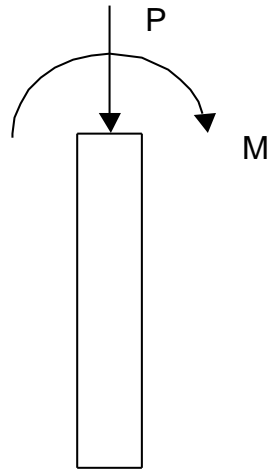

$$fa = \frac{P}{A}$$

$$fb = \frac{M}{S}$$

and the corresponding equation for checking combined stresses:

$$\frac{fa}{Fa} + \frac{fb}{Fb} \leq 1.0 \text{ (Eq 1)}$$

In a solid beam-column these formulae are straight forward in that axial and bending stresses can be calculated directly from the axial force and moment applied to the section.

In a latticed mast, however, leg axial stress is a result of both axial force and moment.

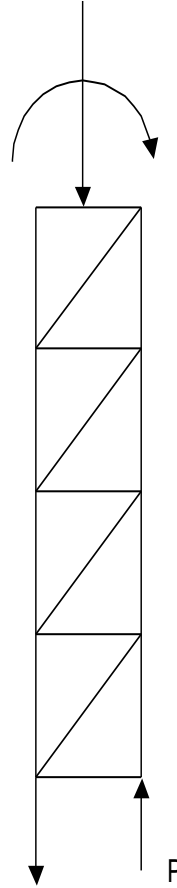

Bending stress in the leg is a secondary stress resulting from continuity of the leg member and is often neglected. As a result, the equation can be rewritten as:

$$\left[\frac{fa_{axial}}{Fa_{axial}} + \frac{fa_{bending}}{Fa_{bending}} \right] + \frac{fb_{sec}}{Fb} \leq 1.0 \quad (\text{Eq 2})$$

where:

fa_{axial} is the compressive stress component due to the axial force in the mast.

Fa_{axial} is the allowable compressive stress considering mast buckling (Kl/r mast) or leg segment buckling (Kl/r leg), whichever is less.

$f_{a_{bending}}$ is the compressive stress component due to bending of the mast.

$F_{a_{bending}}$ is the allowable compressive stress in the leg segment determined from the Kl/r of the leg segment.

$f_{b_{sec}}$ is the bending stress from the secondary bending moments in the leg due to continuity.

F_b is the allowable bending stress in the leg segment.

When the percentage of mast axial force to total axial force in the leg segment is ρ ,

$$\rho = \frac{f_{a_{axial}}}{(f_{a_{axial}} + f_{a_{bending}})}$$

When $f_{a_{bending}}$ is < 0 results in several cases that need to be considered. Note that when ρ is < 0 or > 1 it indicates that the moment is producing total tension or reduction in compression in the member in which case ρ should be set to 0 (stability is not a concern).

We then can rewrite the stress equation as:

$$\left[\frac{\rho * f_{a_{total}}}{F_{a_{axial}}} + \frac{(1 - \rho) * f_{a_{total}}}{F_{a_{bending}}} \right] + \frac{f_{b_{sec}}}{F_b} \leq 1.0 \quad (\text{Eq 3})$$

Relating Eq 3 to Eq 1:

$$\frac{f_{a_{total}}}{F_{a_{equiv}}} + \frac{f_{b_{sec}}}{F_b} \leq 1.0 \quad (\text{Eq 4})$$

Where

$$F_{a_{equiv}} = \frac{1}{\left[\frac{\rho}{F_{a_{axial}}} + \frac{(1 - \rho)}{F_{a_{bending}}} \right]} \quad (\text{Eq 5})$$

A measure of how much the allowable compressive stress of the segment ($F_{a_{bending}}$) is reduced due to mast stability effects $F_{a_{bending}}$ to $F_{a_{equiv}}$ is:

$$Index = \frac{Fa_{equiv}}{Fa_{bending}} \leq 1.0 \quad (\text{Eq 6})$$

Troubleshooting

Modifying the TNXTOWER.INI File

During start-up, tnxTower looks for a special file, *tnxtower.ini*, in the directory where *tnxTower.exe* is installed. This is an ordinary text file that you can edit with the Windows text editor, Notepad. It contains several settings that allow you to customize the manner in which the program works. When the file does not exist, then the program will use default settings.

Restricting Database Access

Add a line:

DbAdmin=myname

where myname is the name of the database administrator who will have the exclusive right to modify the database files. All other users will be restricted.

The current user name in tnxTower is set in the File->Settings dialog. When myname matches this name then the databases can be changed by myname.

When the DbAdmin line is not found or if the *tnxtower.ini* file does not exist, then all users can edit the databases.

Changing The tnxTower Header in Printed Reports

Add a line:

AppName=newname

where newname is the name you want to see in place of tnxTower in the header of printed reports.

When the AppName line is not found or if the *tnxtower.ini* file does not exist, then the name tnxTower will appear in the header of the printed reports.

Frequently Asked Questions

Question 1

When I try to use View/View Reports nothing happens. What gives?

Do you have Microsoft Word installed on your system? When Yes, then go to File|Settings then click on Printer Settings. Check the Use MS Word for Output check box. When you don't have Word, then you need to download the Microsoft Word Viewer (information available here: <http://support.microsoft.com/kb/891090>) and leave the Use MS Word for Output unchecked.

Question 2

How do I view reports if I don't have Microsoft Word?

You need to download the free Microsoft Word Viewer (information available here: <http://support.microsoft.com/kb/891090>). When you install it, the setup program may ask if you want to make Word View the default Word document viewer. When you don't have Word installed on this system then enter "Yes", otherwise enter "No". When you are going to use the Word View, go to File|Settings then click on Printer Settings. Make sure that the Use MS Word for Output check box is not checked.

Question 3

The units that are displayed are not what I want to use. How do I change them?

Go to File|Settings. On the Project Settings tab check either US Customary Units or SI Metric Units. When you need to change a specific unit, say Length, then go to the US Customary Tab and choose the particular Length unit and the precision (how many decimal places to show).

Question 4

My length units are displayed in architectural style. How do I go to decimal format?

Architectural units are only available in US Customary units style. Go to File|Settings. On the US Customary Units tab, uncheck Use Architectural Notation. When you never want architectural to appear on new jobs, then also checkmark the Make These US Settings The Default box and click OK.

Question 5

User Forces use the terms azimuth angle and offset. What is meant by those terms?

The azimuth angle is the number of degrees from North (-Z axis of the tower) measured in a clockwise direction. The offset is the distance from the centroid of the tower along the direction of the azimuth angle.

Question 6

I want to make my tower shorter and eliminate the top two sections, but when I change the tower height, the bottom two sections get eliminated. Help!

Before you change the tower elevation, highlight the two sections you want to eliminate. You do this by clicking on the row numbers in the grid. To select more than one, hold down the shift key and click on each one separately, or merely drag the mouse from the first row number to the last one you want to select. After selecting the rows you want to delete, hit the Delete key. The rows will be eliminated and tnxTower will generate a new row at the bottom of the tower to make up for the lost height. Now enter the new tower height and the bottom row will automatically be deleted since it is no longer needed!

Question 7

When I copy and paste a spreadsheet control row I get garbage in the cells.

You probably did not select and highlight the row before you pasted into it. You need to highlight the row you are copying from by clicking on the row number. Then key in Ctrl+C. This copies the row to the clipboard. Then go to the row you want to paste into and click on that row number and highlight it. Then key in Ctrl+V and the entire row should be pasted from clipboard.

Question 8

When I View CHRONOS Input or Output the text appears in NotePad. How can I change to WordPad?

Easy. Go to Start->Settings->Folder Options. Choose the File Types tab. Then scroll down until you see Text Document (TXT extension). Click on Text Document and press the Edit button. Next click on **open** under Actions: and then press the Edit button. In the Application Used to Perform Action box press Browse and go to "C:\Program Files\Windows NT\Accessories\wordpad.exe" for Windows NT and "C:\Program Files\Accessories\wordpad.exe" for Windows 98. Then Click OK all the way out back to the Desktop.

Question 9

When I enter a latticed pole section the first face width of the main tower always has the same width as the upper tower. I want the main tower to have a different starting face width. How do I do that?

You have forgotten to check mark the "Has Index Plate" box. A tower without an index plate will be forced to have the same face width as the latticed pole section.

Question 10

I receive a message saying that the Sentinel Driver is not present. What do I do?

This usually occurs if you prematurely exited the installation program before the Sentinel driver installation completed. You will need to install the Sentinel SuperPro device driver. To do this, go to www.towernx.com/licensing.html, and download the latest Sentinel System Driver.

#

- # Appurtenances 102
- # Dishes 124
- # Feedlines 114
- # Insulators 100

2

- 28 Day Strength, f'c 128

3

- 3 dB Beam Width 127

6

- 60 Angle 149
- 60 Degree Bent Plate 149

A

- Adding A Latticed Pole To A Tower That Previously Had None 65
- Adding A Section 145
- Adding In User Defined Notes 170
- Adding, Editing and Viewing Material Grades 157
- Adding, Editing and Viewing Sections 145, 160
- Adjustment Factor Face Af 83
- Adjustment Factor Face Ar 83
- Advanced Data 83
- All Guys Identical 94
- Allow Editing 146
- Allow Shielding 117
- Anchor Azimuth Adjustment 94
- Anchor Bolt Grade 128
- Anchor Bolt Size 128
- Anchor Elevation 94
- Anchor Radius 94
- Angle Designations 239
- Angle of Roll 238
- ANSI/TIA/EIA Standards 18
- Antenna Pole Data 111

- Antenna Pole Forces 134
- API Command Line Example 140
- API Commands Usage 139
- API Parameter Table 140
- API Setup In TNXTOWER.INI 139
- Appurtenance Pressures 141
- Appurtenance Shapes 162
- Arbitrary Sections 146
- Area Adjustment Factors 83
- Arm Type 133
- ASCII Cost Output 192
- Assemblies 163
- Assembly Name 49, 67
- Attaching Guys to Candelabra 204
- Auto Correct Height 93
- AutoCad DXF 191
- AutoCalc Flat Attachment Effective Width 121
- Autocalc Gh 48
- AutoCalc Ka 121
- Auto-Calc Single Angle K-Factors 84
- Auto-Calc Solid Round K-Factors 84, 94
- Auto-Calculation of K-Factors 249
- Azimuth Adjustment 103, 126
- Azimuth Angle 108

B

- Base Face Width 47
- Base Plate Grade 128
- Base Plate Is Square 128
- Base Plate Type 129
- Base Type 47
- Beacon Forces 111
- Beacon Length 111
- Before you begin 197
- Bend Radius 66
- Bolt Circle Diameter 128
- Bolt Edge Distance 87
- Bolt Grade 86
- Bolt Size 86
- Bolts Per Stiffener 129
- Bottom Diameter 66
- Bottom Girt Grade 62, 80

Bottom Girt Offset 62, 80
Bottom Girt Size 62, 80
Bottom Girt Type 62, 80
Bracing Type 69
BS Cable 152

C

CaAa 110, 111, 121
CaAa Front 105
CaAa Side 105
Cable Grade 110
Cable Size 110
Calculation of Combined Stress Ratios
in Latticed Masts 255
Candelabra attached to the horizontal
axis 223
Candelabra attached to the tower model
207
Candelabra Data 133
Candelabra Editing and Import 197
Candelabra instructions
Method 1 198
Method 2 201
Candelabra Leg 229
Candelabra Loads 229
Candelabra Pedestal Definition 226
Candelabra Section Sets 230
CAN-S37-01 Input 36
Cantilevered Poles 40
Capacity Tables 142
Cg Factor (CSA-S37) 48
Changing Status 145
Changing The Elevations Of The View
180, 183
Changing The ERI Tower Header in
Printed Reports 258
Channel 150
Clear Spacing 120
Client Name 18
Clipped Corner 129
Code Data 29
Combining Sections 49, 67
Command Line API 139
Component Type (lattice towers) 114
Component Type (monopoles) 115
Configuring tnxTower 17
Connection Data 86
Connection Length Reduction Factor 87
Constant Slope 47
Continuous Members 227
Copying A Section 145
Corporate Logo 20
Cost Data 130
Critical Rotation Reports 42
CSA S37 Standards 18

D

Data Entered by the User 195
Data Entry 8
Data Retrieved from the Database 196
Data Storage Tags 138
Data Tags Management 138
Database 49, 67, 101, 114, 123
Default Load Cases 136
Deflection View 177
Deleting Sections 145
Description 27, 101, 108, 109, 114, 123
Design Code 29
Design Mode 30
Design of Grouted Pipe 254
Design Standard Series 18
Determining Pcrit For Tower Sections
239
Diagonal Grade 62, 80
Diagonal Members 247
Diagonal Offsets 87
Diagonal Size 62, 80
Diagonal Spacing 67
Diagonal Type 61, 79
Diagonal Vertical and Horizontal Offset
Bottom 88
Diagonal Vertical and Horizontal Offset
Top 88
Discrete Load Data 101
Dish Data 123
Dish Shapes 162
Display Features 21
Distribution View 180
Double Angle 148
Double Angle Stitch Bolt At Mid-Point
86
Double Angle Stitch Bolt Spacing 86
Double Channel 150

E

Editing Component Databases 160
Editing Material Databases 157
Editing Section Databases 145
Editing Sections 146
Editing Tower Data 29
EHS Cable 152
Element Map 142
Element Offset 132
Elevation of Base 47
Embedment Length 128
End Fitting Efficiency 94
End Height Above Base 105, 109, 118
Enter pre-defined Gh values 48
Equipment Classification Categories 135
Equipment Load Case Analysis 137

Equipment Load Cases 135
Estimated Cost Data 142
Exclude From Global Torque
 Calculation 117
Export To Other Programs 191
Export to RISA-3D 189

F

Face 114
Face Bevel 77
Face Offset 119
Face or Leg 102, 124
Face Width 67
Feed Line Cluster Treatment (lattice
 towers) 116
Feed Line Cluster Treatment
 (monopoles) 117
Feed Line Load Data 113
Feed Line Shapes 161
Feed Tower Data 109
Feedline Stacking 241
Feedline View 180
File Location Pathnames 18
Flat Attachment Effective Width Ratio
 121
Flat Bar Section 147
Flat IPA on Diagonals 84
Flat IPA on Horizontals 83
Flat IPA on Legs 83
Flat IPA on Poles 83
Force Totals 142
Force-Couple 112
Foundation Data 128
Foundation Stiffness 42
Foundation View 187
Four Sided Tower Equations 237
Frequently Asked Questions 259
Fx, Fz 108

G

Gage Distance 87
General Options 37
General Tower Data 44
Generating Base Tower Data 66
Generating Circular Pole Data 65
Generating Latticed Pole Data 48
Generating Tapered Pole Data 65
Geometry Data 44
Geometry View 165
Girt Offsets 42
Graphic Symbol 102
Grout Space 128
Grouted 128
Gusset Plate Area 86

Gusset Plate Thickness 86
Guy Anchor View 179
Guy Data 89
Guy Data Entry 89
Guy Diagonal Bolt Size 100
Guy Diagonal Grade 100
Guy Diagonal K Factors 100
Guy Diagonal Type 99
Guy Forces 141
Guy Grade 93
Guy Size 94
Guy Tensioning 141
Guyed Towers 144

H

Has Horizontals 77
Has Index Plate 48
Has K-Brace End Panels 77
Height Above Base 89, 108, 127, 131
Height for User Gh 48
Horizontal Grade 62, 80
Horizontal Seismic Force Eh 108
Horizontal Seismic Force Ehx 108
Horizontal Seismic Force EhZ 108
Horizontal Size 62, 80
Horizontal Type 62, 80
How do I change the units? 259
How do I make the tower shorter by
 eliminating its top sections? 260
How do I view reports if I don't have
 Microsoft Word? 259
How K-Factors Are Applied 247
How the Modeler Calculates the Guy
 Anchor Location 247
How Top and Bottom Girts Are
 Generated 240

I

I receive a message saying that the
 Sentinel Driver is not present.
 What do I do? 260
I want the main tower to have a different
 starting face width than the lattice
 pole upper structure. 260
I-Beam Pivot Dist 47
Ice Requirements 31
Impact of monopole feed line and IPA
 settings on Cf and total EPA of
 attachments (TIA-222-G) 243
Import File Name 133
Inner Bracing Grade 63, 81
Inner Bracing Size 63, 81
Inner Bracing Type 63, 81
Inner Diameter/Width 129

Input Data 141
Installing and Configuring 10
Insulator Diameter 100
Insulator Length 100
Insulator Weight 100
Integration with RISA-3D 189
Introduction 7
Irregular Projected Area Adjustment
 Factors (Ratios) 83
Is Strapping? 98

J

Job 18

K

K Factors 84
K Girts 85
K Horizontals, Secondary Horizontals
 85
K Inner Bracing 85
K K-Brace Diagonals 85
K Legs 84
K Redundant Diagonals 85
K Redundant Hips 85
K Redundant Horizontals 85
K Redundant Sub Diagonals 85
K Single Diagonals 85
K Truss-Legs 84
K X-Brace Diagonals 84
K-Brace Horizontals 248
K-Brace Vertical and Horizontal Offset
 Bottom 88
K-Brace Vertical and Horizontal Offset
 Top 88
Keyboard Definitions 27

L

Lateral Offset (Frac of Face Width) 119
Lattice Pole Bracing Types 51
Lattice Pole Diagonal Spacing 50
Lattice Pole Has Horizontals 59
Lattice Pole Has K-Brace End Panels 59
Latticed Pole Height Above Base 49
Latticed Pole Type 46
Latticed Pole Width 47
Leg Compression View 173
Leg Connection Type 86
Leg Connections 251
Leg Grade 61, 79
Leg Size 61, 79
Leg Type 61, 79
License Agreement 12
License Deactivation 17

Licensing 12, 25
List of Necessary Files 193
Logo Bitmap 20
Lower Guy Diagonal Size 100

M

Make These Settings the Default 24
Mast Forces 141
Mast Pressures 141
Mast Shear & Moment View 175
Mast Stability Index 255
Material Take-off View 169
Member Hierarchy 238
Mid Girt Grade 62, 80
Mid Girt Size 62, 80
Mid Girt Type 62, 80
Minimum System Requirements 10
Miscellaneous 31
Model File 190
Modeler Rules 238
Modeling candelabras in RISA-3D 207
Modifying The TNXTOWER.INI File
 258
Monopole Base Plates 187
Monopole Reinforcement 131
Monopoles 239
Mount Type 90
My length units are displayed in
 architectural style. How do I go to
 decimal format? 259

N

Non-Linear Analysis 235
Note/Carrier 102, 114, 124
Number Guy Diagonal Bolts 100
Number of Bolts 86, 128
Number of Elements 132
Number of Mid Girts 62, 80
Number of Sections 49, 66
Number of Sections Between Support
 110
Number of Sides 66
Number Per Row 120
Number Pull Off Bolts 99
Number Torque Arm Bolts 98

O

Offset Distance 108, 124
Offset Distances 103
Offset Type 102, 124
Operating system requirements 10
Options 141
Orientation of Members 239

Oscillations and Fatigue 35
Other Design Options 30
Outer Diameter/Width 129
Out-Of-Plane Restraint 87
Output Options 22
Output Reports 8
Outside Aperture Area 127
Outside Diameter 127
Overall Height 47
Overview 7, 189, 195

P

Pedestal Definition 228
Per Cent Initial Tension 94
Perimeter Offset End 118
Perimeter Offset Start 118
Pipe 147
Plan View 181
Platform Top Above Tower Base 133
Plot Plan View 171
Pole Forces 111
Pole Grade 65, 66
Pole is ground mounted 48
Pole Properties 111
Pole Size 65
Pole Type 65
Preferences 22
Pressure Adjustment Factors 84
Printed Page Layout 21
Printer Settings 21
Program License File 17
Project 18
Project Settings 18
Projection of Discrete Appurtenance
Areas 242
Pull Off Bolt Size 99
Pull Off Grade 98
Pull Off K Factors 99
Pull Off Type 98

Q

Quad Angle 149

R

Readme.txt 10
Redundant Bracing Grade 63, 81
Redundant Bracing Type 63, 81
Redundant Diagonal Size (1-4) 63, 81
Redundant Diagonal Type 63, 81
Redundant Hip Diagonal Size 64, 82
Redundant Hip Size (1-4) 64, 82
Redundant Hip Type 64
Redundant Horizontal Size (1-4) 63, 81

Redundant Horizontal Type 63
Redundant Sub Diagonal Size 64, 82
Redundant Sub Diagonal Type 64, 81
Redundant Sub Diagonal Working Point
64, 82
Redundant Sub-Horizontal Size 64, 82
Redundant Sub-Horizontal Type 64, 82
Redundant Vertical Size 64, 82
Redundant Vertical Type 64, 82
Reinforcing Bolt Hole Dia. 132
Reinforcing Bolts per Row 132
Reinforcing Controlling K 132
Reinforcing Grade 131
Reinforcing Length 131
Reinforcing Shear Lag Factor U 132
Reinforcing Size 132
Reinforcing Type 132
Reinforcing Unbraced Length 132
Report Options 141
Restricting Database Access 258
Round Cluster Dia. 120
Round IPA on Diagonals 84
Round IPA on Horizontals 84
Round IPA on Legs 83
Round IPA on Poles 83
Row Clear Spacing 120
Running the Solution 143

S

Save As Default 36
Schifflerized Angle 149
SDNF 191
Secondary Horizontal Grade 63, 81
Secondary Horizontal Size 63, 81
Secondary Horizontal Type 63, 81
Section Height Above Base 83
Section Length 49, 65, 66, 67
Section Sets Naming Convention 190
Seismic Requirements 34
Seismic User Forces 108
Self-Supporting Towers 143
Self-Weight Multiplier 133
Sending Files To Clients 193
Sending Plots To Clients Electronically
165
Shear 108
Shielding Factor Ka – no Ice 121
Shielding Factor Ka – with Ice 121
Single Angle 148
Single Angle Members 249
Socket Length 65
Solid round legs with sleeve connections
(PiRod sleeves) 253
Solid Round Members 249
Solid Round Sections 146

Solution Control Parameters 143, 144
Solution Parameters 234
Solution Results 142
Some Current Limitations 8
Some Useful Facts 237
Special Note About K-Brace Downs 238
Specifying A Load Combination 175,
177
Specifying A Load Combination And
Guy Anchor Location 179
Splice Length 66
Splitting Sections 49, 66
Start Height Above Base 104, 109, 117
Steel Shapes 146
Stiffener Height 129
Stiffener Thickness 129
Stress Distribution View 183
Strut CaAa Ice 134
Strut CaAa No Ice 133
Summary 29, 83, 101, 107, 109, 113,
123, 128, 130, 131, 133, 135, 138,
139, 143, 165, 169, 171, 173, 175,
177, 179, 183, 185, 187, 191, 195,
197
Synchronizing Databases 153
System of Units 18

T

Taper Height 47
Technical Appendix 234
Technical Support 10
Tension Area Net Width Deduct 86
Tension Area Net Width Deduct Guy
Diagonal 100
Tension Area Net Width Deduct Pull
Off 99
Tension Area Net Width Deduct Torque
Arm 98
Tension Only Systems 41
Tension U-Factor 86
Tension U-Factor Guy Diagonal 100
Tension U-Factor Pull Off 99
Tension U-Factor Torque Arm 98
The Geometry View Toolbar 167
The Overview Window 167
Thermal 31
Three Sided Tower Equations 237
tnxCable 195
tnxCable Report 196
Top and Bottom Pull Off Size 98
Top Diameter 66
Top Girt Grade 62, 80
Top Girt Offset 62, 80
Top Girt Size 62, 80
Top Girt Type 62, 80

Tornado Loads 34
Torque Arm Bolt Size 98
Torque Arm Grade 97
Torque Arm K Factor 98
Torque Arm Leg Angle 97
Torque Arm Size 97
Torque Arm Spread 96
Torque Arm Style 94
Torque Arm Type 97
Total CaAa Ice 133
Total CaAa No Ice 133
Tower Face Width 47
Tower Height Above Base 66
Tower Moment of Inertia 109
Tower Type 45
Troubleshooting 258
Truss-Leg 151
Tubes 148

U

UHS Cable 152
Un-Installing The Program 10
Upper Guy Diagonal Size 100
US Customary & SI Metric Units 23
Use Architectural Notation 24
Use P-delta Analysis 143
User Forces Data 107
User Forces use the terms azimuth angle
and offset. What is meant by those
terms? 259
User Information 20
User Input 141
Using the Candelabra Editor 197
Using The Pop-Up Menu 166

V

Values Calculated by the Program 196
Vertical Seismic Force Ev 108
Viewing Reports 141
Viewing Sections 146
Viewing tnxTower Model Files 193

W

Wall Thickness 66
Weight 106, 108, 110, 111, 122, 127
Weight Adjustment Factors 84
Weight Multiplier 84
When I copy and paste a spreadsheet
control row I get garbage in the
cells. 260
When I try to use View|View Reports
nothing happens. 259

When I View CHRONOS Input or
Output the text appears in
NotePad. How can I change to
WordPad? 260
Wide Flange 151
Wind 111

Wind Area 239
Wind Details 142
Wind Directions 42
Wind Pressure Multiplier 84
Wind Requirements 32